

Making SAP and RdSAP 11 fit for Net Zero

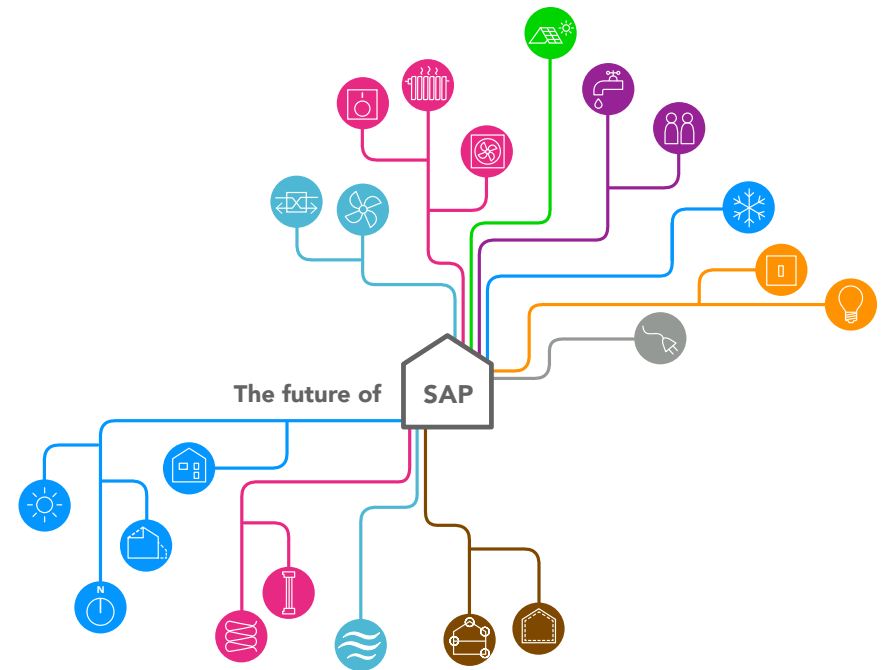

A report for the Department for Business, Energy and Industrial Strategy

June 2021 | Rev K



Levitt Bernstein
People.Design



How do we estimate and regulate the energy and carbon performance of our new and existing homes across the United Kingdom?

With SAP and RdSAP.

These methodologies are therefore of **critical importance** to the delivery of housing and of our climate change objectives.

This independent report summarises **which issues should be addressed** in the next version of SAP and RdSAP and provides **25 key recommendations**.

It is an important step on a journey which aims at making SAP and RdSAP **the best possible methodologies** to assist the design and construction of Net Zero Carbon ready new homes and the low carbon retrofit of the existing housing stock, and to assist home owners in decision making.

Contents

15-minute summary

p.7

1.0

Policies and trends:
the need for a new SAP
for Net Zero

p.18

2.0

What is wrong, doctor?
Key issues with the
current versions of
SAP/RdSAP

p.29

3.0

What can we learn from
others?

p.42

4.0

25 key
recommendations for
SAP/RdSAP 11

p.63

5.0

Feedback from
SAP/RdSAP users and
the wider industry

p.92

6.0

SAP anatomy
and issues log

p.98

7.0

Important additional
information on building
energy models and their
ecosystems

p.107

The SAP/RdSAP scoping project | Executive summary

The importance of SAP/RdSAP is colossal

SAP/RdSAP is not just a calculation methodology: it is integral to the delivery of Government policies associated with the energy performance and carbon emissions of new homes and the whole UK housing stock. While building regulations set the requirements, SAP helps define the targets and constitutes the assessment of the measures proposed. SAP/RdSAP obviously has to be able to deliver a 'pass' or 'fail' for Part L compliance, and continue to produce EPCs, but it is capable of so much more: its importance cannot be overstated.

Making SAP/RdSAP fit for Net Zero

We recommend a clarification of SAP/RdSAP's purpose and a clear hierarchy of functions. The priority functions we recommend on this page derive from the key policy objectives which SAP/RdSAP is crucial for: **Net Zero Carbon, energy efficiency** (including demand reduction and flexibility), and **heat decarbonisation**.

25 key recommendations

As part of this project we have carried out a landscape review (covering housing, technology and the wider energy system), a literature review, and a review of other energy modelling methodologies around the world, and have engaged with experts. These tasks have all provided interesting clues as to how the priority objectives and functions could be better supported in SAP and RdSAP 11. This has led to 25 key recommendations in five categories:

- Alignment between SAP/RdSAP and its strategic objectives
- Improvements to the methodology
- Improvements to SAP/RdSAP and its ecosystem for Net Zero
- A better evaluation of energy use
- Support to decarbonisation of heat and electricity.

A wide industry support

SAP/RdSAP has been the subject of much debate and criticism in the last 10 years. We have tested our recommendations with a wide range of stakeholders, including experts, and we have carried out an industry survey which attracted more than 300 responses. We are glad to confirm that the recommended changes in this document overall received strong support, which is very positive for the future.

1

MAIN FUNCTIONS FOR SAP/RdSAP 11

1. Encourage the right decisions for the design and construction of Net Zero Carbon ready buildings, and for the retrofit of existing dwellings towards Net Zero
2. Evaluate energy use
3. Evaluate carbon emissions, based on an average for the next 20-30 years
4. Improve on current functions for Building Regulations purposes and the production of EPCs to better align with the other priorities

2

SECONDARY FUNCTIONS FOR SAP/RdSAP 11

5. Evaluate energy running costs
6. Evaluate annual space heating demand
7. Provide an indication of how 'smart ready' the home is

3

POTENTIAL ANCILLARY FUNCTIONS FOR SAP/RdSAP 11

8. Evaluate overheating risk, at a high-level at least
9. Support the holistic evaluation of building performance e.g. ventilation.

Recommended hierarchy of functions for SAP/RdSAP 11

Although SAP/RdSAP should continue to be able to perform many functions, being clear on their hierarchy would help SAP/RdSAP 11 perform these functions well

Acknowledgments



Department for
Business, Energy
& Industrial Strategy

We would like to thank everyone at BEIS who led and contributed to this study.

We are also immensely grateful to the experts and stakeholders who have generously given their time to share their experience with us and answered our questions.

Each and every interview has shed an interesting light on SAP/RdSAP's past, present and future.

Tim Baldwin (Shropshire Council)
George Bennett (UCL)
Anna Braune (DGNB)
Julian Brooks (Good Homes Alliance)
Phil Brown (NSG Group)
Niels Bruus Varming (Danish Housing Authority)
John Burke (Building Regulations Unit, NI)
Ronan Casey (Building Regulations Unit, NI)
Juan F. Coronel (University of Seville)
Neil Cutland (Cutland Consulting)
Pierre Damolis (Alto Ingénierie)
Hywel Davies (CIBSE)
Jane Devlin (East Hampshire District Council)
Jeroen Drees van der Sluijs (Plan-AE)
Stuart Fairlie (Elmhurst Energy)
Ian Ferguson (Stroma)
Tilly Ford (Enfield Council)
Paul Keepins (Planning Directorate, Welsh Government)
Haley Gardner (International Living Futures Institute)
David Glew (Leeds Beckett University)
Nigel Griffiths (STBA)
Jessica Grove-Smith (Passivhaus Institut)
Rachel Hay (Climate Change Committee)
Marianne Heaslip (URBED)
Nicholas Heath (NDM Heath, STBA)
John Henderson (BRE)
Jason Hewins (Elmhurst Energy)
Roger Hitchin (Blue Yonder)

This report seeks to reflect the consensus rather than each individual view. The experience of the individuals below and the SAP related groups (SAPIF and SAPSIG), their past and present work must continue to fertilise the development of SAP and RdSAP 11.

Urszula Kasperek (Scottish Government)
Alexandros Kyrkopoulos (Kopitsis Bauphysik AG)
William F M Leech (Fichtner Consulting Engineers Limited)
Mari-Liis Maripuu (CIT Energy Management)
Patrick McCurdie (Energy Efficient Scotland)
Violeta Morosan (Building Regulations Unit, NI)
Tom Naughton (Fairheat)
Viktoria Nadas (Equa Simulation Finland Oy)
Jose Ortiz (BRE)
Jason Palmer (CAR)
John Palmer (Passivhaus Trust)
Alan Pither (AECB)
Simon Rayner (Climate Change Committee)
Martyn Reed (Elmhurst Energy)
Peter Rickaby (UCL/CIMDB)
Viktor Schlegel (Drees & Sommer)
David Shewman (Parity Projects)
Anne Svendsen (Danish Energy Agency)
Andy Simmonds (AECB)
Mark Stewart (Building Standards Division, Scotland)
Lynne Sullivan (Green Construction Board and GHSA)
Lauri Tähtinen (Finish Green Building Council)
John Tebbit (Robust Details)
Colin Timmins (BEAMA)
Chris Twinn (Twinn Sustainability Innovation)
Mika Vuolle (Equa Simulation Finland Oy)
Paul White (Enfield Council)

... and all 337 survey participants!

Project team

This report is the result of a collaboration between partners with different perspectives and experiences but a shared ethos of excellence and knowledge sharing.

The team spans the whole life cycle of a dwelling from planning through design, from construction to operation, with significant experience in both private and affordable housing.

The hard work of these individuals as well as their debates and discussions have been invaluable. They have led to a study which is far more than the view of one single organisation.

The main authors of this report are listed on the right-hand side but we would also like to thank all those at **Elementa/Integral Group** who have contributed to the international domestic energy modelling methodology review, and in particular:

USA/Canada reviews

Jeremy Field, John Nelson, Jared Landsman, Lisa Westerhoff
Kevin Leung, Tom Marseille, Bilal Maarouf, Shreshth Nagpal, Jon Lutz, Brenden McEneaney, Andrej Simjanov.

Australia review

David Barker, Akhil Mohan.



Julie Godefroy
Anastasia Mylona



James Parker
Elanor Warwick



Clara Bagenal George
Marguerita Chorafa



Clare Murray
Zoe Watson



Tadj Oreszczyn



Barry Evans
Snighda Jain



Caitlin Bown
Rachael Collins
Tom Gwilliam
Leon Tatlock
Chris Worboys
Thomas Lefevre

15-minute summary



This section provides a brief summary of:

- Why SAP/RdSAP needs to change
- What we have learnt from others (SAPIF report, literature research, engagement with experts) and from our review of other energy modelling methodologies for domestic buildings around the world
- Our 25 recommendations to improve SAP and RdSAP
- The results of our industry survey of SAP/RdSAP users

Our methodology

Principles

Our work, undertaken during the COVID-19 pandemic (Aug 2020-Jan 2021), adopted the following key principles to address the ambitious brief set out by BEIS. It was clear that our work should not just focus on which algorithms in the SAP / RdSAP methodology should be changed:

- Being **open minded**: approaching the review with as wide a scope as possible to consider all options, from only minor improvements to a complete re-think.
- **Learning** from experts, past experience, the literature and from what is being done across the world for energy modelling of domestic buildings.
- Being as **evidence-based** as possible and highlighting gaps or differing opinions.
- Taking account of and expressing the **view of SAP /RdSAP users**.
- Working as a **diverse team from industry and academia**, with different areas of expertise, in order to challenge ourselves.

Methodology

The **landscape review** helped to define what has changed and the context which SAP/RdSAP 11 needs to respond to. We have also engaged with BEIS to understand the key policy objectives SAP/RdSAP needs to support (section 1).

We have undertaken a **deep analysis of SAP/RdSAP** and what works well or not, to identify big and detailed issues that need addressing (section 2 and Issues Log, which should be read in conjunction with this report). This analysis also included the production of diagrams on **how SAP and RdSAP work** (i.e. inputs, calculations, outputs) (section 6).

The review of literature, advice from experts, and other modelling methodologies across the world helped us to identify **possible solutions** (sections 3 and 7).

This led to **25 key recommendations** which together form a solution, based on our analysis of what SAP/RdSAP needs to achieve and what the options are (section 4).

Engagement with industry helped to gather information and test and refine our recommendations (section 5).

We have done our best to be specific about the use of "SAP" and "RdSAP" but for the avoidance of doubt, recommendations on SAP as a calculation method also apply to RdSAP, since their inputs differ but the calculation method is the same.

WHAT DO WE WANT FROM SAP/RdSAP 11 (section 1)

WHAT CAN WE LEARN FROM OTHERS, WHAT OPTIONS ARE AVAILABLE FOR IMPROVEMENTS TO SAP/RdSAP? (section 3; section 7 for in-depth review)

HOW DOES SAP CURRENTLY WORK FOR WHAT WE WANT? (section 2)
ANATOMY OF SAP (section 6)

RECOMMENDATIONS FOR SAP/RdSAP11 (section 4)
FEEDBACK FROM INDUSTRY AND OTHER STAKEHOLDERS (section 5)

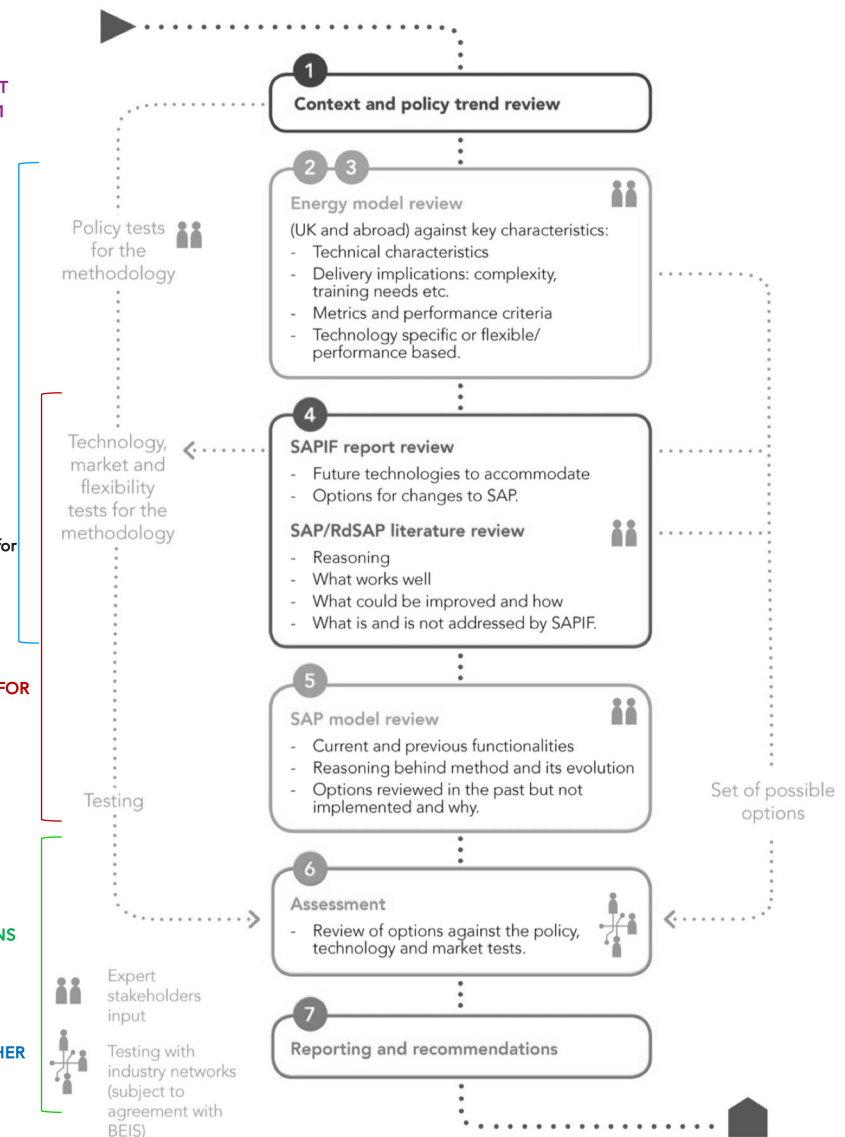

Methodology adopted for this process, and corresponding sections of this report. This review uses the draft SAP10 (version 10.1, 1st October 2019) as reference.

The need for a new SAP/RdSAP for Net Zero

The importance of SAP/RdSAP is colossal

SAP/RdSAP is not just a calculation methodology: it is integral to the delivery of policies associated with the energy performance of new homes and the whole UK housing stock, and it is used from small works to large new developments, often as design tool (even if it was not intended as such). While regulations set the requirements, it is in large part SAP/RdSAP which defines the target and the assessment of the measures proposed.

SAP/RdSAP is also a central tool for those developing, implementing and tracking policies (e.g. BEIS, MHCLG, Ofgem, Climate Change Committee, Local Authorities, National Grid), for residents (the ultimate stakeholder), and for the whole building industry (developers, affordable housing providers, housebuilders, investors, manufacturers, energy assessors, engineers, architects etc.).

Its importance cannot be overstated.

The purpose and functions of SAP/RdSAP need to be clear

SAP/RdSAP has been developed over more than 20 years and its purposes and functions have expanded over time, leading to a lack of clarity. We recommend a clarification of its purpose and a clear hierarchy of functions, as outlined opposite. SAP/RdSAP should continue to be able to perform other functions, but its main purpose should be to deliver on these priority ones.

These priority functions are derived from the key objectives which SAP/RdSAP is crucial for: **Net Zero Carbon**, **energy efficiency** (including demand reduction and flexibility), and **heat decarbonisation**. Reducing fuel poverty is also a key objective which SAP/RdSAP needs to help with, but SAP/RdSAP can only address some of the causes of fuel poverty, and other important levers are also available for this.

SAP/RdSAP 11 needs to be suitable for the future

SAP/RdSAP 11 is expected to be available from 2023-2024. It is therefore crucial that its development takes into account the current trends affecting housing, the energy system, technologies and innovations in performance testing.

It is also particularly important to embrace a culture based on evidence and in-use data: a new system must be put in place to track policy effectiveness and progress towards Net Zero, and continuously improve SAP/RdSAP.

1

MAIN FUNCTIONS FOR SAP/RdSAP 11

1. Encourage the right decisions for the design and construction of Net Zero Carbon ready buildings, and for the retrofit of existing dwellings towards Net Zero
2. Evaluate energy use
3. Evaluate carbon emissions, based on an average for the next 20-30 years.
4. Improve on current functions for Building Regulations purposes and the production of EPCs to better align with the other priorities.

2

SECONDARY FUNCTIONS FOR SAP/RdSAP 11

5. Evaluate energy running costs
6. Evaluate annual space heating demand
7. Provide an indication of how 'smart ready' the home is.

3

POTENTIAL ANCILLARY FUNCTIONS FOR SAP/RdSAP 11

8. Evaluate overheating risk, at a high-level at least
9. Support the holistic evaluation of building performance e.g. ventilation.

Recommended hierarchy of functions for SAP/RdSAP 11

Although SAP/RdSAP should continue to be able to perform many functions, being clear on their hierarchy would help SAP/RdSAP 11 perform its priority functions particularly well.

Key issues with the current versions of SAP/RdSAP

There is a combination of issues that affect the perception of SAP/RdSAP, how it is utilised and the usefulness of its outputs. Most relate to SAP/RdSAP itself but others to the way it works with the Building Regulations and Approved Documents (or equivalents in the devolved administrations e.g. Technical Handbook).

Key issues for Net Zero Carbon

- The EPC rating generated by SAP/RdSAP, i.e. the main metric used in policy to drive improvements to the housing stock, is an **energy cost metric, not an energy efficiency or carbon metric**. At current energy prices, this means the use of **fossil fuels** can be encouraged by EPC ratings produced by SAP/RdSAP.
- SAP-calculated carbon emissions for Part L compliance use **short-term carbon factors** which are rapidly out of date and do not reflect the lifetime carbon impact of decisions.
- The key SAP output for Part L compliance is a **relative** improvement over a **notional building**, not an absolute performance metric. This prevents evaluation of impact, tracking of progress, and benchmarking, and does not reward some important aspects of energy efficient design (e.g. building form).

Key issues for energy efficiency and demand reduction/flexibility

- Energy use (in kWh) is **not a key SAP/RdSAP output** for Part L and EPC ratings. Primary energy, cost and carbon metrics are all system-dependent rather than reflecting the building itself and cannot directly be checked post-completion.
- The evaluation of energy use is **not accurate** (e.g. location is standardised)
- Peak demand reduction and flexibility** are not encouraged.
- On **existing homes**, SAP/RdSAP does not set out an end-goal compliant with Net Zero Carbon nor a coherent set of options to achieve it. SAP is also not often used: Part L compliance can be achieved through elemental checks only, and EPCs are in majority produced with RdSAP, using less specific inputs.

Key issues for energy efficiency and demand reduction/flexibility

The **decarbonisation of heat is currently hindered** by SAP/RdSAP.

This report focuses on the 'big issues' but we have also created a 'SAP/RdSAP issues log' to capture all issues – see Section 6 and separate Excel file for details.

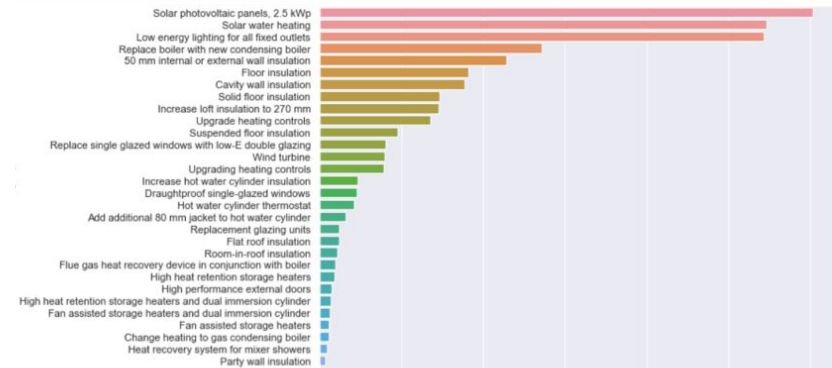

Analysis of recommendations generated by SAP/RdSAP on all UK EPC certificates. While this scoping project focuses on SAP/RdSAP, and therefore EPC ratings rather than their recommendations, this is linked and clearly illustrates that the current system is not fit for purpose to put the existing housing stock on the right track towards Net Zero. For example, the installation of a heat pump is never recommended, which is partially due to the current nature of the EPC rating: a cost indicator rather than an energy efficiency or carbon metric (Source: UCL)

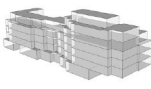
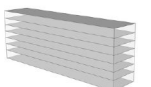
	Improvement over Part L (%)	Space heating demand (kWh/m ² /yr)	Space heating demand (kWh/m ² /yr)
	SAP	SAP	PHPP
High form factor 	35%	18	26
Medium form factor 	35%	15	20
Low form factor 	37%	11	13

A more efficient form is important for low energy buildings, but it is not rewarded by the notional building approach: with similar specifications (e.g. U-values) the performance against Part L (%) calculated by SAP for the three buildings above is broadly similar despite the space heating demand being much smaller with a more efficient design (40% smaller as estimated by SAP, and 50% as estimated by PHPP).

Learning from others and working together for a better SAP/RdSAP

Building on the significant knowledge acquired over 20 years+

We have engaged with a number of experts: people who have been directly or indirectly involved in the development of BREDEM, SAP and RdSAP, people who are at the heart of the software solutions using these methodologies, and people who have had to consider SAP/RdSAP in a lot of detail through research and analysis of its accuracy, at the building or stock level. We are very grateful to all of them and their names can be found on page 5 of this report. They have explained to us why and how BREDEM, SAP and RdSAP have evolved over time and why some choices have been made. We recommend building on this great legacy.



A selection of reports and papers included in the literature review

Literature review (including the SAPIF report)

Findings from the literature review have informed all aspects of this report. We have reviewed in detail the Climate Change Committee's Future of Housing report, the SAP Industry Forum (SAPIF) Technologies report and several other relevant publications. They must inform the development of SAP and RdSAP 11.



A review of domestic energy modelling and standards used across the world has been undertaken

Learning from other domestic energy modelling methodologies

A comprehensive review of domestic energy modelling methodologies and standards used across the world has been undertaken, supplemented by a more detailed analysis of some key methodologies and by interviews with individuals whose names can also be found on page 5. PHPP is clearly a methodology to learn from but there are also others. For retrofits, methods developed in the UK as adaptations to SAP/RdSAP are considered a very good place to start.

Being ready to make new choices

It is important to acknowledge that the development of SAP/RdSAP over the last 10 years has been made somehow on an 'ad hoc' basis rather than led by a strategic vision. **As Government and the wider industry consider SAP/RdSAP a key tool to help deliver Net Zero Carbon ready buildings and the whole house retrofit of existing homes, new choices, possibly different from the ones made so far, should now be made.** In particular, the need to evaluate energy use more accurately, the energy system revolution and its impact on demand flexibility, the heat decarbonisation priority and the need for SAP/RdSAP to play a role in reducing the performance gap are key reasons for these new choices.

Building Energy Models In-depth Review PHPP	
Summary Energy model: PHPP Purpose: Passivhaus Standard certification Use type: Domestic and non-domestic, new build Location: Central Standard, used all over the world Scope: All energy use inc lifts Simulation: PHPP (Passivhaus Planning Package) Tool:	Main differences with SAP Metric: Absolute metrics based on space heating demand and primary energy Heating, hot water and ventilation system: The systems are input in a much more detail and project specific manner Treatment of unheated spaces in corridors: In PHPP all areas within the thermal envelope are included. In SAP walls to adjacent corridors are assumed to be external (with factors) Solar gains: Calculated in more detail Internal gain assumptions: In validation mode, PHPP fixes the internal gains from hot water, appliances, hot water and people at 2.1 W/m². In design mode, changes can be made to the fixed assumption to reflect real conditions. SAP assumes gains from hot water and appliances based on standard occupancy. Internal gains: The PHPP limit on internal gains from people and appliances maintains the standard to which the fabric is designed. In SAP, higher internal gains can be set against a lower standard for the thermal envelope. Internal gains from appliances can be assumed in PHPP but not SAP. Philosophical approach to achieving energy: In validation mode, PHPP assumptions default to a higher five meeting compliance harder to achieve. This encourages the user to set the reference or a design tool. Some of the assumptions in SAP default to a more energy efficient answer than the likely realistic, making compliance easier. Validation: PHPP is calibrated against measured fuel use data from over 500 buildings built to the Passivhaus standard, since the 1990s. SAP was calibrated during the 1990s against monitored data from several hundred dwellings built to better than the building Regulations standards of the time. Thermal Bridges: Thermal bridging is calculated in much more detail Ventilation system: Systems are modelled and takes account of the design of the system as a whole including duct lengths and their insulation. Measurement of air infiltration: Air leakage into an air change/hour @ 50 Pa in SAP Air permeability in m³/h @ 50 Pa. Shading: Detailed inputs on depths of window reveal per window and shading factor input per window for summer and winter shading.
Metric and targets Space Heating Demand: $\le 15 \text{ kWh/m}^2$ Primary Energy Renewable: 500 kWh/m^2 Airtightness: $\le 0.6 \text{ air change/h} @ 50 \text{ Pa}$ Additional metrics target: Included Additional metrics target: Absolute Air tight test: As built test As built test: No test	
Further Requirements In-use energy disclosure: None Proven track record against actual in-use performance: Yes (details to be given) Any as built tests required: Airtightness test for whole building Other Requirements (e.g. for regular inspection of heating and AC systems): None Performance or prescriptive requirements apply: Performance based, although prescriptive airtightness requirements apply Limiting parameters: Only airtightness	

A selection of methodologies has been reviewed in detail (e.g. PHPP)

25 key recommendations to make SAP/RdSAP 11 fit for Net Zero

Making SAP/RdSAP fit for Net Zero is possible

The review of policy objectives with BEIS and of the changing landscape around new and existing housing has led to the clarification of the objectives and functions of SAP and RdSAP. These functions need to derive from the key Government policy objectives which SAP/RdSAP is crucial for: **Net Zero Carbon, energy efficiency** (including demand reduction and flexibility), and **heat decarbonisation**.

The literature review, our engagement with experts and our review of other energy modelling methodologies around the world have all provided interesting clues as to how these objectives and functions could be better supported in SAP and RdSAP 11. They have led to **25 key recommendations**.

These recommendations focus primarily on what is within SAP and RdSAP's remit. If they are all addressed, these methodologies will be much more able to deliver their new key objectives: accompany the design and construction of new Net Zero Carbon ready new homes and the low carbon retrofit of existing homes.

Additional points to address have been identified in the Issues Log.

Addressing SAP/RdSAP as well as its ecosystem

Some of these recommendations go beyond the strict boundaries of SAP/RdSAP. They have been made to ensure that there is consistency between methodologies and their 'eco-system', which is absolutely crucial as the right environment will make changes to the methodology even more effective, and a number of important issues cannot be resolved by SAP/RdSAP alone. The development of the Future Homes Standard provides a natural opportunity for both SAP and its regulatory environment to be considered together. For these improvements to be considered.

Alignment between SAP/RdSAP and its strategic objectives

1	SAP can and must become a tool for Net Zero Carbon ready new buildings
2	SAP/RdSAP can and must become a better tool for whole house retrofit
3	SAP/RdSAP can and must become better at evaluating energy use
4	Homes need to become smart ready and SAP/RdSAP needs to help with this
5	SAP can and must play a bigger role in reducing the performance gap

Improvements to the methodology

6	Carbon factors: replace the short term with long term factors (e.g. 25-year average)
7	SAP should remain a steady-state monthly tool, but with a new module for flexibility
8	SAP should 'tell the truth' and enable bespoke non-regulatory uses
9	A significant improvement of Appendix Q and the PCDB process is required
10	Overheating: towards a simplified 'flagging system'?
11	SAP/RdSAP outputs need to be compatible with disclosure and data analysis goals

Improvements to SAP/RdSAP and its ecosystem for Net Zero

12	No more notional building: the introduction of absolute energy use targets
13	New metrics for Net Zero Carbon (and not primary energy)
14	Better governance: a modular architecture and an evidence-based culture
15	New EPC ratings from SAP/RdSAP to support Net Zero and fuel poverty objectives
16	SAP should be fully integrated in the digital age

A better evaluation of energy use

17	Location should be taken into account and not normalised as it is now
18	Domestic hot water should be modelled more accurately
19	SAP/RdSAP should better model the energy performance of ventilation systems
20	Thermal bridges: good practice should be rewarded (and bad practice penalised)
21	SAP needs to better reflect all energy uses, including cooking and white goods
22	Occupancy: the standardised assumptions should be re-validated

Support to decarbonisation of heat and electricity

23	SAP/RdSAP needs to model all heat pump systems accurately to reward efficiency
24	Heat networks: SAP/RdSAP should evaluate distribution losses more accurately
25	Solar Photovoltaics require better modelling and a prominent SAP/RdSAP output

The result: a better SAP/RdSAP towards Net Zero

Priority policy objectives	SAP/RdSAP 11 potential performance against objectives	
Net Zero Carbon by 2050	✓	<p>Significant improvements</p> <ul style="list-style-type: none"> The redefinition of SAP's main purpose as a tool to assist the delivery of Net Zero Carbon ready new buildings would ensure alignment between the strategic objective, the process of designing and constructing new homes and the SAP methodology. SAP and RdSAP would better support a whole house retrofit approach and indicate what improvements to energy and carbon performance are possible, which means opportunities could be identified, accelerating improvements to and decarbonisation of the existing stock. The SAP outputs would be used against an absolute target, consistent with the nature of the Net Zero Carbon target which is absolute. SAP would consider regulated and unregulated energy uses, i.e. total energy use. This total energy use metric can be checked post-completion and therefore it would create a positive feedback loop, increasing clarity for consumers and enabling government to monitor policy effectiveness, track decarbonisation and carry out forecasting to achieve Net Zero. SAP would use medium-term carbon factors (e.g. 25-year averages) which would reflect forward-looking scenarios for the electricity grid, better representing the average carbon emission of a home over the next 25 years, rather than its immediate emissions.
<p>Improving energy efficiency and reducing demand</p> <p>New and existing homes</p>	✓	<p>Significant improvements</p> <ul style="list-style-type: none"> The key metric in SAP/RdSAP would be energy use, the best indicator of energy efficiency. The evaluation of energy use would be more accurate by having an assessment based on the actual location of the dwelling (e.g. regional). Additional accuracy would be possible by enabling users to adjust inputs for non-regulatory purposes e.g. occupancy, heating set points. SAP would continue to include a fabric and ventilation efficiency metric to express thermal demand related to fabric performance. This metric may be a Space Heating demand metric or the Heat Transfer Coefficient metric. The inclusion of an output related to peak demand and/or demand management (e.g. Smart Readiness Indicator, energy storage capability, peak demand) would allow SAP to value strategies aimed at reducing peak demand and at shifting demand for system flexibility. These would in turn support policies for the electricity grid to become lower carbon at a smaller cost. Having energy use as a key metric, and better evaluating it, would also improve SAP/RdSAP's ability to support fuel poverty policies where it best can: reducing energy use through building performance.
Heat decarbonisation	✓	<p>Significant improvements</p> <ul style="list-style-type: none"> SAP would use medium-term carbon factors (e.g. 25-year averages). This would support policies to move away from fossil fuels. Key technologies for the decarbonisation of heat (e.g. heat pumps) would be better modelled. The assessment of hot water demand would be more detailed, reflecting its growing relative proportion of total heat demand in new buildings. SAP would no longer use a notional building, helping to accelerate the transition away from fossil fuel heating. SAP would not include "fudge factors" intended to support particular systems or technologies; it would assess low-carbon heat options on a fair basis and support a faster transition away from fossil fuel heating.

Summary of feedback from SAP/RdSAP users: shared views

We undertook an online survey and received 337 responses. A number of questions were met with consensus and in general a undeniable support for change. Results are summarised in Section 5.0 with full results provided in Appendix H. This page highlights the key areas of consensus.

Target setting



“ An absolute figure ensures the focus remains on a directly measurable aspect, enabling simple reporting of future improvements. ”

68% believe the notional dwelling is not a useful measure and that an absolute target should be set instead

Key metrics

85%

think energy use should be a key metric

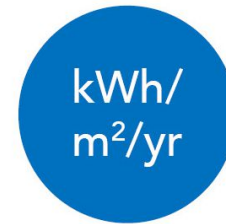

Use SAP as a design tool

85%

would like to see the SAP methodology also used for non-regulatory purposes, with more detailed inputs, allowing for a more accurate assessment of building performance

“ Is there any justification for not doing this? ”

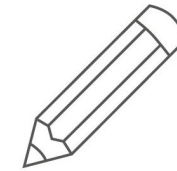

“ This would help to communicate the difference between SAP as a regulatory tool and as a potential model for individual dwelling performance. ”

Use SAP for retrofit

It is clear that respondents think SAP should be a tool to better inform retrofit.

80-87% thought that to be a sufficient retrofit tool SAP should:

- Evaluate possible deep retrofit 'end goals'
- Introduce prompts to encourage 'whole-house thinking'
- Take better account of airtightness and other associated improvements

Those who did not, tended to think that SAP was not a detailed enough calculation methodology at the moment.

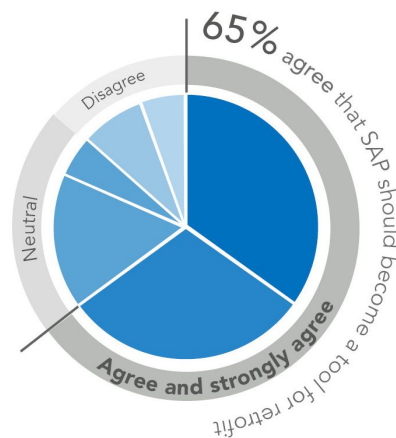

Encourage demand management

80%

agree, with over half of these strongly agreeing.

75-80% agreed that to do this SAP should account for:

- Peak electrical demand
- Thermal storage
- Smart technologies
- Electrical storage

Use actual dwelling location

90%

agree that SAP should be based on a dwelling's actual location, rather than a normalised one



The anatomy of SAP and RdSAP: diagrams

Visualising the different components of SAP and RdSAP

It may appear to be a detail, but we think that the absence of a diagram expressing how SAP and RdSAP work represents a barrier for a better understanding of what could/should be improved.

For this reason, we have produced a number of diagrams as part of this scoping project:

1. a SAP 2012 diagram
2. a SAP 10 diagram
3. a simplified SAP 10 diagram
4. an RdSAP diagram.

Using these diagrams to understand differences and assist development

We have used these diagrams to visualise differences, i.e.

- changes between SAP 2012 and SAP 10
- differences between SAP and RdSAP.

There is additional potential in the future to use these diagrams to visualise where changes are required and where underlying evidence is weaker.

Developing a more open development culture around SAP

We recommend that similar diagrams are developed for SAP and RdSAP 11. They could contribute towards a more open development culture around SAP with the update of different component parts or modules being displayed more clearly or call for evidence for other elements.

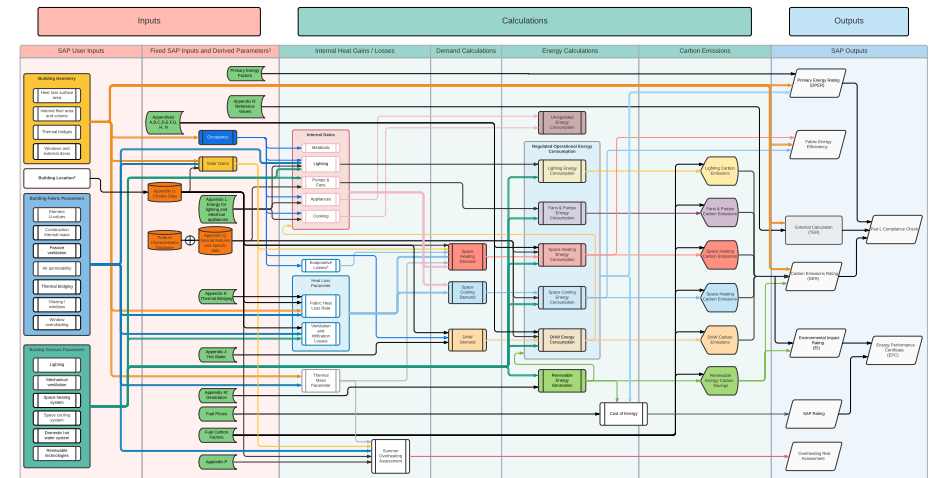

SAP 10 diagram developed as part of this SAP 11 scoping project
(larger size available in Section 6)

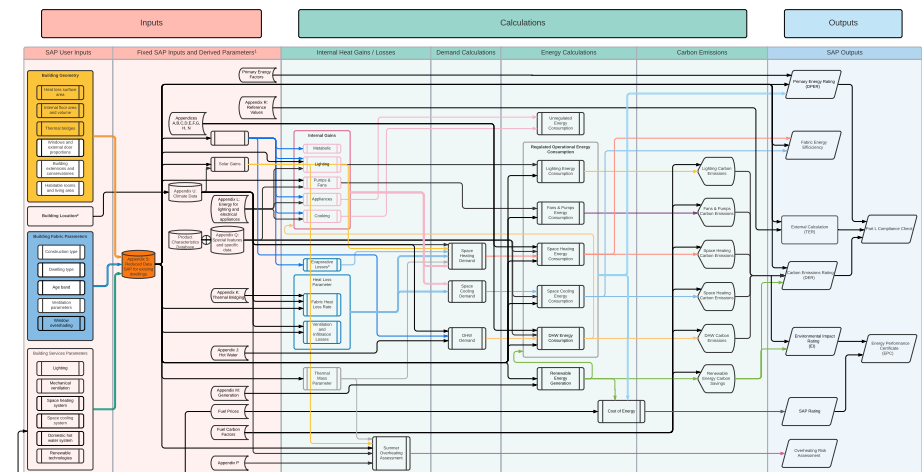

RdSAP diagram developed as part of this RdSAP 11 scoping project
(larger size available in Section 6)

























Next steps

The aim of this project was to summarise which issues should be addressed by SAP/RdSAP 11 and to provide a set of clear recommendations for the team who will develop them.

In the process of developing these recommendations, we have been able to identify areas where there is a strong consensus and others where opinions are more split. Based on our engagement with experts and on the online survey, recommendations in the adjacent table which are marked with three ticks  have a particularly high level of support in the industry.

We have also provided an assessment of the level of complexity associated with delivering each recommendation. The adjacent table seeks to summarise this: recommendations marked with three “plus” (+++) are more complex, so they will require time to develop and incorporate satisfactorily in SAP/RdSAP 11. These include:

- The role of SAP and RdSAP to help deliver the whole house retrofit of existing homes
- How SAP can help homes to become smart ready (i.e. how it can assess peak demand reduction and shifting to coincide with renewable energy generation) and the development of the associated new SAP module providing more functionality and flexibility
- A review of the role and the process of Appendix Q and the PCDB.

		Level of consensus	Level of complexity
1	SAP can and must become a tool for Net Zero Carbon ready new buildings		+
2	SAP/RdSAP can and must become a better tool for whole house retrofit		+++
3	SAP/RdSAP can and must become better at evaluating energy use		++
4	Homes need to become smart ready and SAP/RdSAP needs to help with this		+++
5	SAP can and must play a bigger role in reducing the performance gap		++
6	Carbon factors: replace the short term with long term factors (e.g. 25-year average)		+
7	SAP should remain a steady-state monthly tool, but with a new module for flexibility		+++
8	SAP should ‘tell the truth’ and enable bespoke non-regulatory uses		+
9	A significant improvement of Appendix Q and the PCDB process is required		+++
10	Overheating: towards a simplified ‘flagging system’?		++
11	SAP/RdSAP outputs need to be compatible with disclosure and data analysis goals		+
12	No more notional building: the introduction of absolute energy use targets		+ new / ++ existing
13	New metrics for Net Zero Carbon (and not primary energy)		+
14	Better governance: a modular architecture and an evidence-based culture		++
15	New EPC ratings from SAP/RdSAP to support Net Zero and fuel poverty objectives		++
16	SAP should be fully integrated in the digital age		++
17	Location should be taken into account and not normalised as it is now		+
18	Domestic hot water should be modelled more accurately		++
19	SAP/RdSAP should better model the energy performance of ventilation systems		+
20	Thermal bridges: good practice should be rewarded (and bad practice penalised)		++
21	SAP needs to better reflect all energy uses, including cooking and white goods		++
22	Occupancy: the standardised assumptions should be re-validated		+
23	SAP/RdSAP needs to model all heat pump systems accurately to reward efficiency		++
24	Heat networks: SAP/RdSAP should evaluate distribution losses more accurately		++
25	Solar Photovoltaics require better modelling and a prominent SAP/RdSAP output		+

Next steps | Learning from domestic energy modelling methodologies across the world

Domestic energy models for new and existing dwellings from Europe and across the world have been reviewed, along with their ecosystems (e.g. the regulatory framework around them). This page provides a summary of our findings and how they can help to inform the development of some key aspects of SAP/RdSAP.

40+ ecosystems, modelling methods and tools reviewed

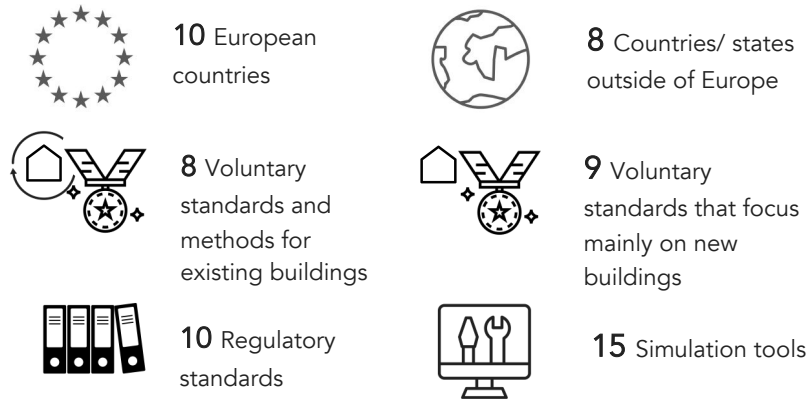

Best practice ecosystems

- A clear long term target definition of zero carbon
- Stepped targets, and clarity on future targets that improve over time
- Various routes to compliance
- Building labelling and disclosure
- Best-in-class building fabric
- Scrutiny of thermal bridging and details
- Clear differentiation between design checks and in-use reporting
- Enhanced energy modeller qualifications
- Inclusion of embodied carbon, refrigerant leakage and resilience metrics

Of the reviewed regulatory and voluntary standards:



12 have a total energy use (EUI) metric



15 have a space heating metric

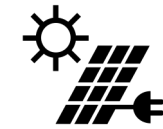

13 have an on-site renewables metric



18 have an absolute target



12 Methods encourage fabric first standards and are steady state



11 require data disclosure

Best practice modelling methodologies

- Same tool used for regulation and voluntary standards
- Methods used for both regulatory compliance and predictive modelling, but often allowing different inputs and functionality
- Evolution of metrics and targets over time
- Reporting and reducing peak energy use
- Holistic design taking account of energy and overheating
- Clear reporting templates
- Different methodologies depending on the scale of the development

Best practice tools

- Simple user interface
- Transparency of simulation tool

1.0

Policies and trends: the need for a new SAP for Net Zero

This section provides an overview of key Government policy objectives and the role that SAP/RdSAP can play to help deliver them.

The changing landscape is summarised in terms of housing in general, the wider energy system, environmental trends as well as technological developments.

SAP/RdSAP: a 'central' methodology

SAP/RdSAP is a central tool for delivering Government objectives

SAP/RdSAP is not just a calculation methodology: it is integral to the delivery of UK policies and the performance of the whole housing stock:

- While initially developed for an assessment of energy running costs it has become, by far, the main tool to assess the fundamental performance characteristics of homes for policy or regulatory purposes: energy use, carbon emissions, renewable energy generation and energy costs. This is the case at individual dwelling level, including through Building Regulations and regulations which rely on EPCs (e.g. MEES). It also has a role at stock level, as the National Housing Model is largely based on the same methodology.
- SAP/RdSAP is used throughout the housing sector, for stock management and from small works to large new developments.
- While regulations set the requirements, and Approved Documents the reliance on a notional dwelling, it is SAP which defines and assesses the notional dwelling. SAP is therefore integral not only to the evaluation of dwellings, but also to the performance required of them.
- While regulations vary across the UK, the SAP methodology is used in all four nations. Only the associated targets and elemental performance requirements vary, through regulations and guidance, and this is only in a limited manner as the notional dwelling used to set the target is largely the same.
- SAP/RdSAP also to some extent influences the strategies for ventilation and thermal comfort, and therefore the health and wellbeing of occupants.

SAP/RdSAP landscape review

SAP/RdSAP is used by many key stakeholders for the implementation and tracking of policies including: BEIS (e.g. heat decarbonisation, energy efficiency, fuel poverty, energy infrastructure), MHCLG (e.g. new housing), Ofgem (e.g. fuel costs, management of ECO), Climate Change Committee, residents, industry (housebuilders and their supply chains, manufacturers, energy assessors, engineers, architects etc) and investors (e.g. climate bonds).

This section reviews the landscape within which SAP/RdSAP operates and what has changed since its creation, to define what it must be able to respond to: policy objectives, and trends in housing, technology, and the energy system.

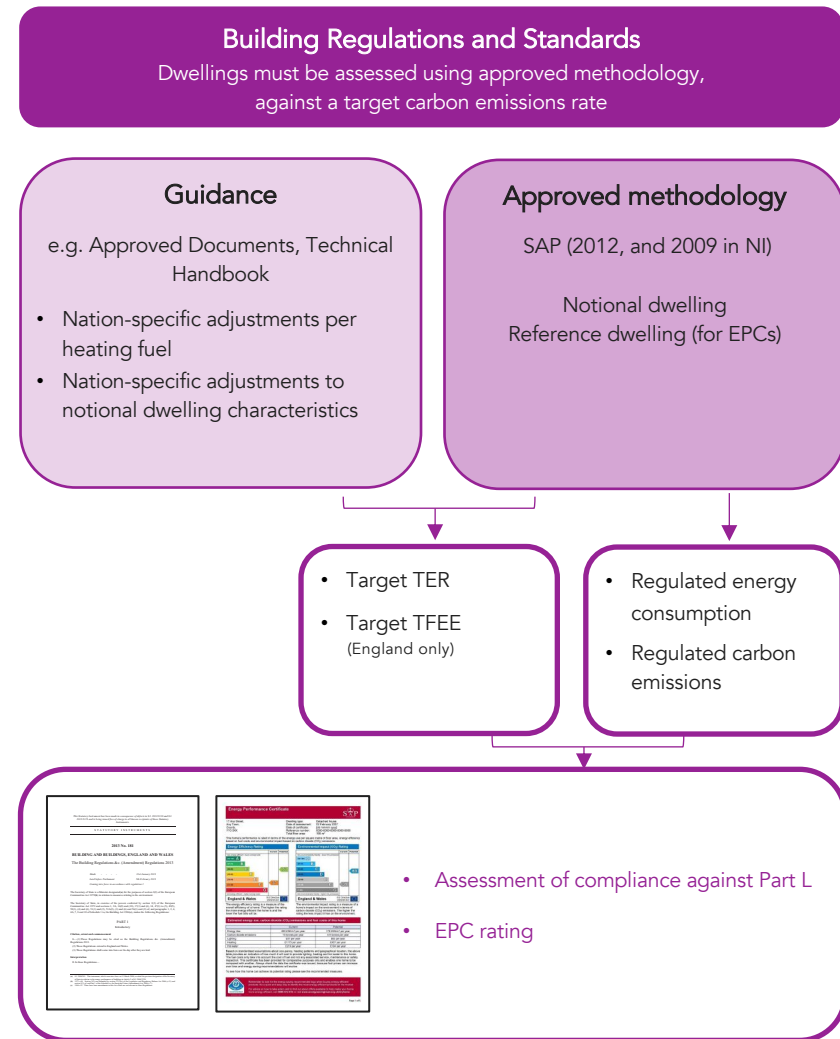

SAP/RdSAP is a central tool for the delivery of energy and carbon objectives for housing across the four nations, including the assessment of dwellings and the target they have to meet.

The hierarchy of Government policies which SAP needs to help deliver

SAP/RdAP is embedded in key policies

Over the decades since its creation, SAP/RdSAP has gradually become embedded in a number of policies. They include major and overarching policies, in particular those around decarbonisation and the reduction of fuel poverty.

For some policies, objectives are directly expressed using SAP/RdSAP *outputs* (e.g. Building Regulations, MEES). For others, SAP/RdSAP outputs are used to track implementation or inform policy, directly or through models based on SAP (e.g. National Housing Model). SAP/RdSAP also influences the implementation of other policies in the housing sector (e.g. on innovation or construction methods), though less directly.

Clarifying the priorities for SAP

Some applications of SAP/RdSAP have taken it quite far from its initial purpose. Currently it may not be suited to all its applications, which does not help outcomes and often contributes to the criticism of SAP. In practice, it is not expected that a single method could do it all, and do it well. A clear requirement from BEIS was to establish **priority policy objectives which SAP must support**, while other objectives could be primarily addressed through other means. This would help improve SAP in line with its intended purpose, and ensure that SAP users are clear on what it can do, when it is suitable to use it, and with which caveats. This would improve outcomes and help re-build trust in the methodology.

H

HIGH PRIORITY POLICY OBJECTIVES FOR SAP/RdSAP

- Net Zero Carbon by 2050, of which decarbonising the housing stock is a major component and directly linked to SAP/RdSAP
- Energy efficiency and reducing demand
- Heat decarbonisation

M

MEDIUM PRIORITY POLICY OBJECTIVES FOR SAP/RdSAP

- Reducing fuel poverty
- Increasing renewable energy generation
- Electrical demand management
- Engagement with customers
- Construction quality

L

LOW PRIORITY POLICY OBJECTIVES FOR SAP/RdSAP

- Electrification of transport
- Health and wellbeing
- Faster housing delivery

Our recommendations on the main policy objectives with some association to SAP/RdSAP, developed in conjunction with BEIS

Note this is not a ranking of the policy objectives as such, but of their importance for the development of SAP/RdSAP i.e. it reflects the policy objectives which SAP/RdSAP needs to consider in priority, because it is closely associated with it, it is well placed to deliver it, and/or because there are few other levers available to help towards the objective.

Policy review | Policies which SAP/RdSAP is linked to

Our policy review has identified a number of policy objectives which SAP is linked to, directly or not. They are illustrated here, along with a commentary on the nature of their link to SAP. How much they depend on SAP, and the impact SAP can have on delivering the objective. The nature of these links has been central in informing our recommended hierarchy for the functions of SAP/RdSAP. A more detailed and systematic review of each policy and its link to SAP is included in Appendix F.

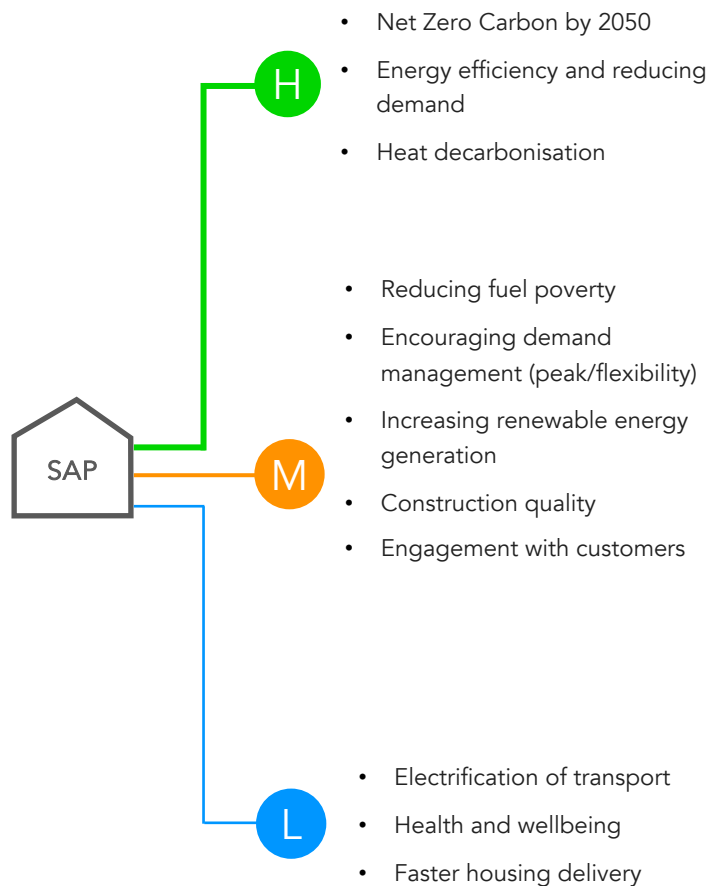

Close and direct link between SAP and these policy objectives, typically directly through SAP outputs
e.g. Building Regulations, Minimum Energy Efficiency Standards (MEES)

SAP is the only or main tool to deliver these policy objectives

These policy objectives directly relate to building physics (e.g. energy use, space heating demand) which is at the core of what SAP deals with, rather than more complex socio-economic factors

These policy objectives can be linked to a SAP output, but other factors are also at play. These factors may be socio-economic rather than purely technical. Other levers are available which, combined with SAP outputs, can deliver the objective, e.g.

- energy use matters to fuel poverty, but so do energy prices and household income. Other levers include tariff caps and income support.
- SAP can help reduce peak demand, and possibly evaluate it and its time of use, but energy tariffs, products, grid system measures are also available and impactful on demand reduction and management

These objectives do not directly rely on SAP outputs. SAP could only have a limited impact, and there are many other levers available to address these objectives. In the case of electrification of transport and housing delivery, the link to SAP is mostly that they could influence the context that SAP operates in, and the inputs it needs to accommodate, e.g. SAP could be able to account for electric vehicle charging and accommodate innovation.

Health and wellbeing is an important building performance issue, but only partially relates to energy performance: its evaluation relies on additional inputs and often a more complex or very different method e.g.

- thermal comfort and overheating rely on dynamic phenomena and site factors (typically addressed by planning rather than Building Regulations)
- air quality relies not only on ventilation, but also indoor and outdoor pollutants, not accounted for in SAP.

Fuel poverty and SAP/RdSAP

Fuel poverty and the role of SAP/RdSAP

A household is considered to be in fuel poverty if it cannot afford to keep its home adequately warm at a reasonable cost for its income. It is a consequence of energy use (including energy efficiency), energy prices, and household income.

The preponderance of fuel poverty and how it is defined and measured vary across the UK, with around 10% of households in England, 12% in Wales, and 25% in Scotland. Estimates in Northern Ireland vary widely, from 22% to 42%. These proportions have remained relatively stable in the past 15 years, except possibly in Northern Ireland, with energy efficiency improvements balancing increases in energy prices (House of Commons Library, 2020; CCC, 2020).

Many fuel poverty policies seeking to address energy use and costs rely directly on SAP/RdSAP, through the EPC rating which is a cost indicator. They include:

- England and Wales: Minimum Energy Efficiency Standards (MEES), and Private Rented Sector (PRS) regulations to reach EPC C by 2030 (under consultation).
- England: Green Homes Grants, which for PRS require a minimum EPC rating of E, in line with MEES.
- Scotland: Home Energy Efficiency Programme and Energy Efficiency Standard for Social Housing use EPCs. A new fuel poverty strategy is expected in 2021.

Our understanding is that fuel poverty policies in Northern Ireland do not rely on EPCs (they use criteria such as household income or boiler age), but an updated strategy is expected in the future.

SAP/RdSAP are also used in fuel poverty policies in other ways e.g. fuel poverty statistics (BEIS, 2020) and energy costs produced on EPCs.

Reducing energy costs while moving away from fossil fuels

Improving the energy efficiency of homes is considered a major opportunity to help address fuel poverty, as well as delivering co-benefits such as air quality and comfort. One of the current barriers to effective action on fuel poverty and carbon emissions is however the discrepancy between costs and carbon impacts of electricity and gas. At current prices, seeking to reduce energy costs can favour gas over electricity. This needs to be addressed. In the meantime, focusing on reducing energy use is recommended as it helps reducing both carbon and costs.

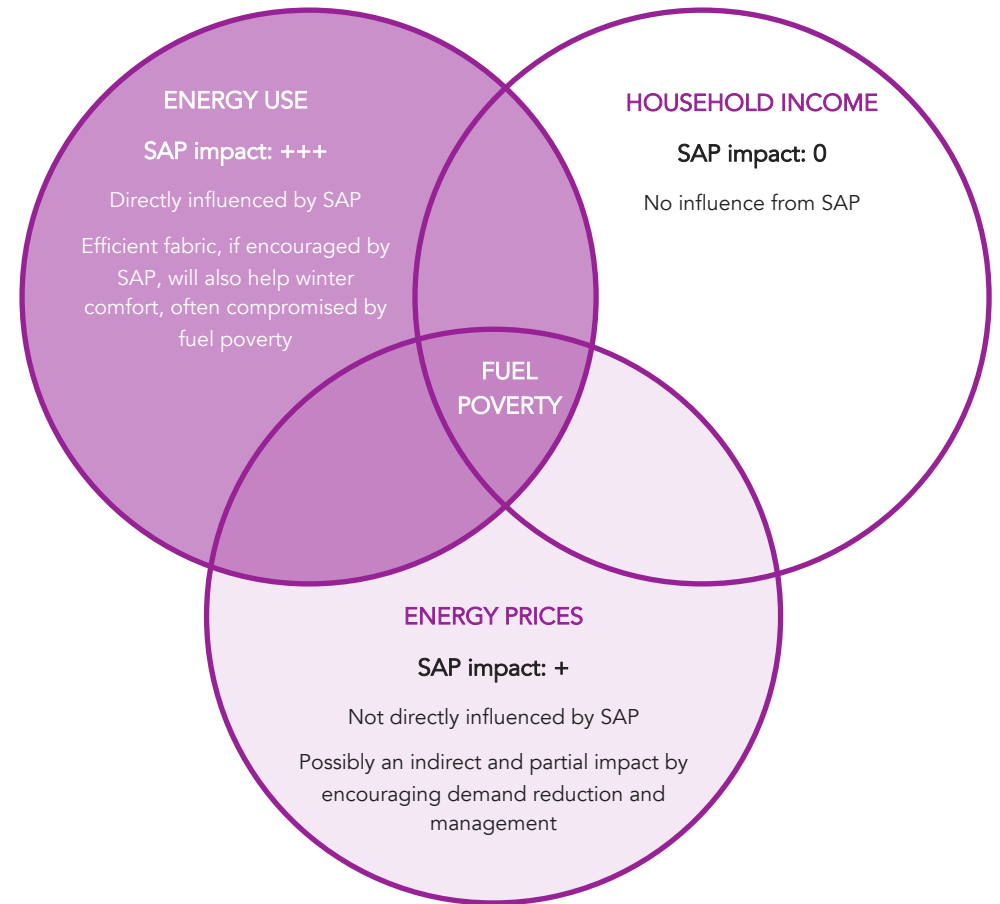

Fuel poverty is the result of three factors. The most appropriate and effective SAP output to this end is not energy costs (as in current EPC ratings), but energy use.

Towards energy pricing consistent with carbon and fuel poverty objectives



“The uneven distribution of policy and carbon costs on electricity and gas penalises low-carbon electric solutions”
(CCC 6th Carbon Budget– Policies report, December 2020)

The discrepancy between costs and carbon impacts of electricity and gas needs to be addressed for effective action on fuel poverty AND carbon emissions. To limit the occurrence and depth of fuel poverty, investment in energy efficiency is also required.

Housing trends

Homes need to be flexible to meet current and future needs

The homes we build today should be able to last more than 200 years. This means that every home is likely to be occupied by perhaps 20 households and 70 individuals over its lifetime. Even if we could meet the needs of the first occupants, we would be wise to look far beyond this. The COVID-19 pandemic has demonstrated how variable energy use and occupancy profiles can be, and that adaptability of our existing stock is as important as flexibility of new builds.

Tenure and occupancy

Build to rent, private rentals, houses in multiple occupation, multi-generational housing and affordable housing experience higher occupant density or even overcrowding (9% of social renters and 7% of private renters lived in overcrowded accommodation according to the English Housing Survey in 2019-20). This may affect the amount of heating and energy use. Under-occupation (i.e. having two or more spare bedrooms) increased for owner occupiers and declined for renters in the last 20 years.

Adaptability

Older people tend to spend longer at home and to suffer more from excess heat or cold, leading to (if they can afford it) a greater winter heat demand. SAP should contribute to comfort and low energy bills by providing a robust assessment of fabric, which will reward high performance.

An ageing population also comes with assistive technology and a requirement to charge wheelchairs and mobility scooters, increasing unregulated energy demand. The development of SAP should consider how such loads are accounted for (alongside electric vehicles), to facilitate links with actual energy in use.

Layout

The trend for open plan living sees larger parts of homes more intensely heated. This can extend to the loss of hallways to make way for larger combined kitchen, living and dining spaces – increasing heat loss from living spaces through the front door. The lack of space in new homes means washing is often dried in living or bedroom spaces, adding to humidity levels and to the need for additional background ventilation to reduce condensation and mould growth.

Procurement

Currently the 10 largest housebuilders are the dominant provider of new homes. Looking ahead, more varied routes such as self-builders and community-led housing could become more frequent, and are an ambition of Government.

Construction contracts that guarantee performance and competence through the industry will need to become more widespread, for example to install and commission heat pumps or ensure quality of build and airtightness.

What the public want: 20 principles of the Home of 2030

A home that gets the basics right (including daylight and thermal comfort)	93%
A home that is affordable to run so I can still live a comfortable life	93%
A home where I don't have to worry about everything working as it should	90%
A home that is simple to fix and maintain without assistance	89%
A home with plenty of convenient travel options so that I can get around easily	83%
A home that has quality private or shared gardens	81%
A home that is in a neighbourhood that has all the amenities that a community of all different ages may need	80%
A home that is environmentally friendly and is part of a response to climate change	79%
A home that looks attractive and has its own identity	76%
A home that makes it easier for me to make more sustainable living choices	76%
Having control over what digital technology can do in my home	70%
A home that is easy to adapt or extend	66%
A home that is my current home, but with improvements	62%
Having the opportunity to contribute to the design of my home	60%
More choice and freedom over my housing options	59%
A home where it is possible for me to work from home	48%
A home which is suitable for multiple generations of my family to live in	48%
Having regular contact with my neighbours	45%
A home that is innovative and different to what people have seen before	33%

Characteristics that relate to SAP (darker pink: close link / lighter pink: looser link)

A Public Vision for the Home of 2030, Design Council, 2020

Homes within a changing and smarter energy system

Transport electrification, heat electrification, and its decarbonisation of the through often intermittent renewable sources are all placing significant challenges on the electricity grid. Homes will need to play a role to help reduce demand and shift it at suitable times for the system. This will help to ensure that demand is met and decarbonisation continues in the most cost effective manner. SAP/RdSAP should therefore be able to assess the technologies that will support this transition.

Electricity grid decarbonisation and the role of energy management

With decarbonisation of the electricity grid, peak demand and the ability to be flexible in a system dominated by intermittent renewable energy and inflexible nuclear generation will become more important. When energy is used will increasingly matter, as well as how much of it is used.

Energy management in homes will therefore become increasingly important, both for electrical and thermal demand. In addition, the deployment of smart meters mean that homes can benefit from using Time of Use (ToU) variable price electricity tariffs which are also encouraging the use of energy at better times for the systems. These opportunities are supported by automatic control systems of increasing sophistication, such as Hive, Nest and Tado. Altogether, by shifting the timing of their energy demand, occupants can have lower bills, even if the total energy demand does not change. Because cheaper electricity correlates significantly with periods of lower carbon electricity generation these tariffs can play a role in reducing the carbon emissions of the home.

SAP/RdSAP is currently not capable of assessing these benefits in energy costs or carbon emissions.

Renewable energy generation on buildings

The Climate Change Committee estimates that in order to meet our Net Zero obligation, solar generation capacity will need to increase by an average of 3GW per year to 2050 (from a current total capacity of 13GW) and that maximising its potential will entail using 1500 km² of land use in addition to the current 290 km² (CCC, 2020 a,c). Building-mounted solar PVs would help reduce pressures on available land for solar generation and generate energy close to its point of use. Smart controls and energy storage can help to maximise this benefit for residents.

The future of heat

Over the last two decades heating for homes has in majority been from mains gas as the main heating system (or otherwise oil or containerised gas), although this varies across the nations. Direct electric (resistance heating) and heat pumps are relatively uncommon. Government has however announced that from 2025 fossil-fuel heating will be banned in new build homes.

Hydrogen is not expected to be widely available as an energy vector at the domestic scale in the course of this decade, if ever, and there are remaining uncertainties about how it will be produced and stored, and the impact of these choices on overall energy use, carbon emissions and costs¹. For example, electrolysis from renewable energy could generate zero carbon hydrogen, but hydrogen generated through steam methane reformation with limited carbon capture would be relatively high carbon. The cost of heating via hydrogen are currently uncertain and may be prohibitively expensive.

Nevertheless, there are likely to be hydrogen trials before the end of the 2020s ahead of availability at scale, as announced under the government's 10-Point Plan, and SAP 11 will need to be able to account for this if these trials are successful.

Until/if hydrogen is available, electricity will increasingly be used for heating in homes, and is very likely to become the dominant home energy vector. This means that SAP/RdSAP needs to be able to assess the range of electrical heating systems available, including heat pumps, and their range of performance in terms of energy use, carbon emissions, impact on peak and flexibility or 'smart readiness'.

Electric vehicles

Up to now vehicles have used petrol/diesel and have been completely separate from homes. It is now government policy that each new home should have an electric vehicle charging point, and it is likely that from around 2025 most new cars sold will be electric. Although not currently a regulated energy demand, it is difficult to ignore the scale of this impact, particularly as they are unlikely to be just a passive 'behind the meter' demand, they may store and supply energy.

¹ Hydrogen - A decarbonisation route for heat in buildings? (LETI, 2021)

Key technologies for tomorrow's homes

SAP needs to represent technologies with a key role for Net Zero

Many current and emerging technologies likely to play a significant role in our homes from the mid 2020s are not adequately addressed in SAP, either through lack of available selection or insufficient configurability to represent their benefits. This can disincentivise their use and be detrimental to achieving Net Zero. This needs to change to make SAP relevant to ultra-low energy homes that are dynamically integrated in tomorrow's energy system, flexible, and able to model future technology developments.

Key technology areas

A key aim for SAP 11 (including Appendix Q and the Product Characteristics Database - PCDB) should be to suitably address modern technologies and construction methods, and capture the benefits of future technologies and constructions more quickly and easily.

- Greater options and scope for modelling **heat pump technologies and their control systems**, and servicing strategies. There is now a wider range of systems available with varying features and characteristics beyond those in SAP.
- **Energy storage** solutions can reduce and/or shift peak electrical and thermal demand. This includes principally thermal storage (e.g. hot water tank, thermal mass) and how this storage is integrated and controlled. The draft SAP 10 already accounts for electric storage (e.g. batteries linked to PVs) but in-use data and the potential impact of electric vehicles and mobility vehicles for an ageing population should also help refine the methodology.
- **Smart home controllers and thermostats** can have significant benefits, for example occupancy detection and easier programming/scheduling.
- **Smart meters** open significant opportunities for demand management, performance analysis and consumer engagement.
- Other technological developments, as they arise. For example, SAP 10 proposes a more accurate evaluation of lighting consumption, including LEDs and the actual number of fittings. Further improvements, such as automatic controls, could potentially be added too.



Key technologies currently included within the Product Characteristics Database

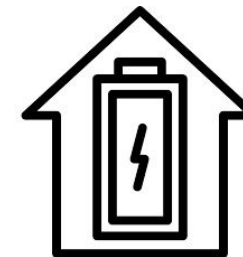

Whilst the draft SAP10 now includes electric batteries linked with PVs, further innovations in thermal and electrical storage and demand management in general will need to be included in SAP11.

New as-built and in-use testing techniques

Recent technological developments offer opportunities for faster, cheaper and less intrusive testing of a home's actual energy performance at the as-built and in-use stages. SAP should make the most of these opportunities to create closer links between design calculations, as-built and in-use testing. As much as possible, it should use outputs which can be verified at the as-built or in-use stages.

Airtightness

A good level of airtightness testing has been shown to reduce heat demand (and improve overall built quality) but inputs on airtightness are not even required in RdSAP and current blower door tests (under pressure) are simple but not straightforward for existing homes.

Low-pressure pulse tests are carried out at near-ambient pressure conditions with less site preparation than for a blower door tests. MHCLG have recently confirmed in the January 2021 response to the Part L and Future Homes Consultation that they will be allowed for Building Regulations purposes, and the CIBSE TM23 methodology is being reviewed accordingly. These tests could therefore become more common at the as-built stage (e.g. for compliance purposes) but also to inform the assessment of existing buildings and potential retrofit measures. This could lead to a significant change, reducing reliance on default values in SAP/RdSAP, and encouraging more attention to build quality.

Heat transfer coefficient

The heat transfer coefficient (HTC) is a measure of overall fabric performance: it is the rate of heat transfer per degree of indoor-outdoor temperature difference. It includes heat losses from transmission, infiltration, and ventilation.

While HTC has long been recognised as a very useful measure of building performance, until recently the main methodology to measure it was a co-heating test, which typically excludes the effect of ventilation, is generally expensive and disruptive. A home needs to be unoccupied and heated for at least two weeks.

Recent innovations could transform this. The SMETER trials, run by BEIS, are testing 8 products which offer estimated HTCs through analysis of meter data (typically smart, but not necessarily) with additional information on the home and household (e.g. occupancy patterns, heating set points). Reporting on the trials is expected in Q2 2021.



Equipment for a pulse airtightness test. The method is non-intrusive and typically takes under an hour to be applied (source: Build Test Solutions)

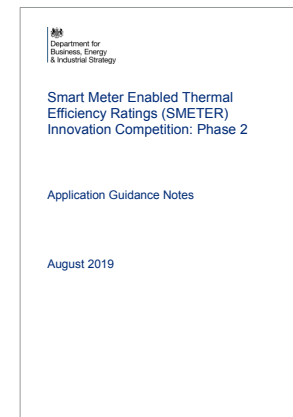

While SMETER is currently focused on individual homes, and the techniques developed may currently be more applicable to existing rather than new homes, this could still open significant opportunities for measuring in-situ performance in a non-intrusive way, with applications both at building level and for stock analysis.

BEIS competition for SMETER trials

SAP and the data revolution

Significant new opportunities

Capabilities for energy data monitoring and analysis of complex and large datasets have hugely increased in recent years. Protocols and experience are also increasingly available on how to do this while protecting householders privacy.

This opens up a number of opportunities:

- At building or development-scale, **monitoring actual performance** possibly against regulatory or planning requirements. For example, the new London Plan includes a “be seen” policy, which requires disclosure of energy in-use (in aggregate for dwellings).
- At the building and dwelling levels, for consumers and professionals to **evaluate building performance**, and identify opportunities for energy savings through management, improvements and retrofit.
- At stock level, **monitoring the effectiveness of policy** for new buildings and retrofit of existing buildings by reviewing trends in energy use against policy implementation and changes to stock properties.
- To **inform the development of SAP** e.g. changes to the methodology to better account for actual performance, new functions if in-use data shows this is required, such as for demand management. This could also make the process of integrating new technologies into SAP quicker, more transparent and more robust. Currently, this is lengthy and much revolves around setting out an assessment methodology and lab testing of new products or systems. Better monitoring capacities offer the opportunity to introduce products and gradually refine the way they are assessed in SAP, based on actual performance data.

Examples are provided in the adjacent boxes. This is only a small selection: for example, BEIS are undertaking research matching smart meter data to English Housing Survey Data (for publication in 2022). The Energy Systems Catapult has also recommended coordination of asset registration for a modern digitised energy system, and SAP could be part of this with building passports.

SAP needs to act as a better and more direct bridge between design, policy, and actual in-use data. With the growing use of large datasets and analytical techniques there is a real opportunity for SAP 11 to be designed to generate data that will help us to better understand the building stock and inform policy going forward.



Example 1 – Stock level - NEED and metered data – What energy savings can be achieved through retrofit?

The NEED database cross-analyses data on energy use, retrofit measures, and assets and households characteristics (from a range of sources). This makes it a rare and valuable source of information about actual energy savings from retrofit. However, its value is greatly limited by the lack of depth of information on the home and the works carried out. In particular, details of the measures installed and intended savings are not available, which makes the analysis of actual savings limited and generic. This would be addressed if SAP inputs and outputs were available for the analysis.



Example 2 – Stock level – UCL project for BEIS (UCL, 2019) : Are EPCs an effective tool for energy efficiency policy?

This project cross-analyses multiple large datasets on actual energy use, EPC ratings, and stock-level information from a range of sources, covering over 400,000 homes. This allows an analysis of trends in energy use e.g. per housing type, per household type, per EPC rating. However, as EPC ratings relate to energy costs, it is not possible to make direct comparisons between in-use energy and that evaluated by SAP (behind the EPC), which could help improve SAP as well as identify possible reasons for poor energy performance in use.



Example 3 – Building level – SMETER trials: Fabric performance for space heating may soon easily be measured, but can we check it against what it was designed to be?

The SMETER trials, if successful, will allow a home’s actual Heat Transfer Coefficient to be tested easily. However, tested HTC’s cannot currently be directly compared with SAP outputs: HTC’s are calculated by SAP but are not an output and some processing would be needed, on a project-by-project basis, to make comparisons of design vs actual HTC.

Examples of opportunities for building performance analysis through increased availability of in-use data, and improved data processing. They could help answer key questions to take our building stock to Net Zero Carbon, but are currently limited by SAP outputs, inputs, and their accessibility.

Conclusion: a clarified purpose and a clear hierarchy functions for SAP/RdSAP 11

Having established the priority policy objectives that SAP/RdSAP 11 should contribute to deliver and reviewed trends in housing, technologies and the energy system we, have defined the priority functions for SAP/RdSAP 11:

1. **Encourage the right decisions for the design and construction of Net Zero Carbon ready buildings and the retrofit of existing dwellings towards Net Zero.**
2. **Evaluate energy use**, to contribute towards energy efficiency and help engage with consumers.
3. **Evaluate carbon emissions, based on an average for the next 20-30 years.**
4. **Current functions for Building Regulations purposes and the production of EPCs** must be retained but may evolve in order to better align this function with the other priorities. Leaving the EU possibly offers opportunities for new approaches, outside of the EPBD framework.

It is also important to:

- Evaluate energy running costs
- Evaluate annual space heating demand
- Provide an indication of how 'smart ready' the home is, e.g. by evaluating peak and variable demand or assessing the ability of the home to store energy.

Additional useful functions can be derived from the above, but should not be primary drivers to the development of SAP:

- Evaluate overheating risk, at least at high level: this does not mean it is of lesser importance; however, the priority should be to fill this function in the best possible manner without affecting the core function of SAP, rather than influence the core energy-focused methodology for that purpose.
- Support the holistic evaluation of building performance: similarly to overheating, this does not mean that issues such as ventilation and mould are not essential, but that they are not best dealt with through SAP. Closer links between energy and air quality should be required through regulations and compliance checks. SAP should at the very least evaluate energy use from ventilation, through options for evaluating the appropriateness of ventilation could be reviewed.

1

MAIN FUNCTIONS FOR SAP/RdSAP 11

1. Encourage the right decisions for the design and construction of Net Zero Carbon ready buildings, and for the retrofit of existing dwellings towards Net Zero
2. Evaluate energy use
3. Evaluate carbon emissions, based on an average for the next 20-30 years.
4. Improve on current functions for Building Regulations purposes and the production of EPCs to better align with the other priorities

2

SECONDARY FUNCTIONS FOR SAP/RdSAP 11

5. Evaluate energy running costs
6. Evaluate annual space heating demand
7. Provide an indication of how 'smart ready' the home is

3

POTENTIAL ANCILLARY FUNCTIONS FOR SAP/RdSAP 11

8. Evaluate overheating risk, at a high-level at least
9. Support the holistic evaluation of building performance e.g. ventilation, mould.

Recommended hierarchy of functions for SAP/RdSAP 11

2.0

What is wrong, doctor?

Key issues with SAP/RdSAP

Any successful improvement programme starts with an honest and thorough review of what the problems appear to be.

They may be directly related to SAP/RdSAP, to its 'ecosystem' or to how SAP/RdSAP is used (or misused). They may be small or detailed issues.

They all matter.

Big and detailed issues – everything counts

Nearly 20 years ago, the first version of SAP, based on BREDEM, was published by BRE and the Department of the Environment. It is now impacting a billion-pound industry. It is also affecting the value of homes and even the potential to rent properties and technologies live or die depending on how they are treated by SAP.

In order for SAP/RdSAP to be as good as it can be and worthy of the impact it now has, it is important to start with an assessment of the combination of big and detailed issues that affect its perception, the way it is utilised and the usefulness of its outputs. Improving SAP/RdSAP will require the courage to 'fix' the big issues as well as the patience to address the detailed issues: for Net Zero, they all matter.

For clarity, this review considers the current draft SAP 10 (version 10.1, 8th Nov 2019) as the main reference. Points specific to SAP 2012 are also made.

The big issues

This chapter focuses on the key significant issues affecting SAP, ranging from the purpose of SAP and its associated misuse or EPCs generated by SAP/RdSAP not driving low carbon retrofits, to the importance of how carbon factors are set. Most of these issues are with SAP itself but some are related to the way SAP, the Building Regulations (or equivalents in the devolved administrations) and associated guidance (e.g. Approved Documents in England and Wales, Technical Handbook in Scotland) work together.

They are intertwined and SAP is part of the bigger puzzle. It has therefore become clear to us that SAP cannot be treated in isolation of the Building regulations, nor the built environment industry that uses it. For SAP 11 to become the best possible tool for Net Zero, consistent changes are also required to SAP and its ecosystem.

Key detailed issues

We have also created a separate 'SAP/RdSAP issues log' to capture key detailed issues. The log shows how some of them have to do with inputs, calculations or outputs of SAP. The minor ailments have also been listed which would benefit from being patched up as part of the 'smaller' fixes.

Section 6 provides more information on this 'SAP/RdSAP issues log'. This is designed to be a working document that can be edited and updated as SAP evolves.

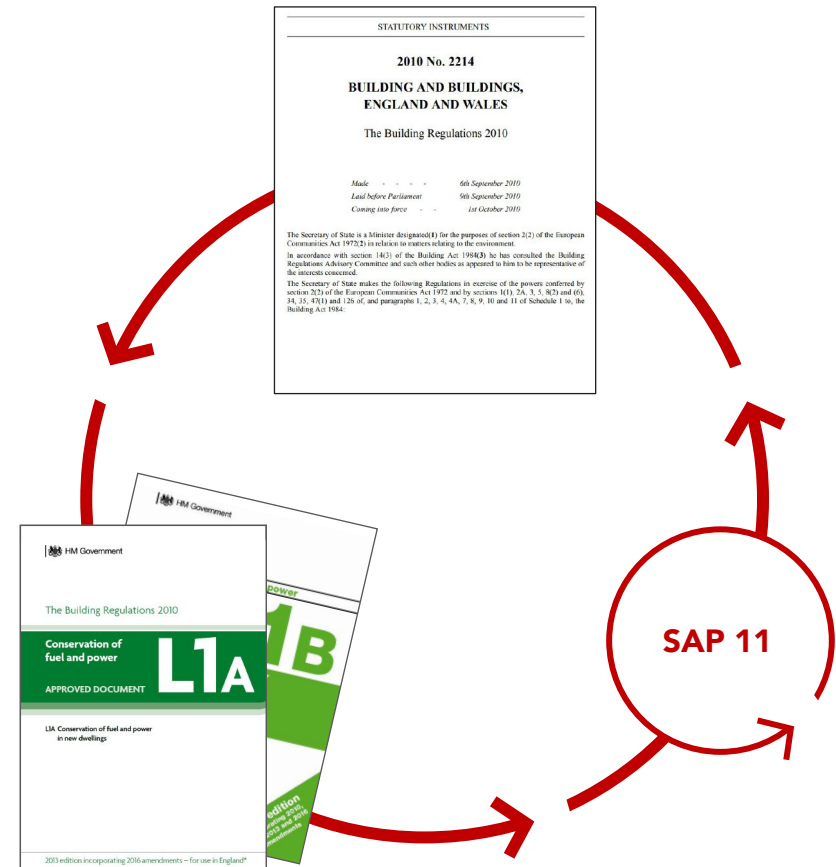

SAP 11 – Big issues and detailed issues all have to be addressed for SAP 11 to be the best tool it can be and effectively help to deliver Net Zero Carbon

The purposes of SAP/RdSAP are now unclear

What is the issue?

SAP was originally designed with one key objective: to represent a standardised fuel cost to achieve comfort under given conditions (e.g. occupancy and location) that allows one dwelling to be compared with another and a value placed on energy improvement. This objective had to be met by a simple methodology: the calculations needed to be possible without requiring a computer.

As any tool, SAP has since developed and gradually used in a range of other unintended ways. Among others, it is now being used for the following, whether or not users are aware of its limitations for these purposes:

- to evaluate energy use
- to estimate energy costs
- as a planning compliance tool
- as an iterative design tool for low/zero carbon buildings
- as an assessment tool to inform low/zero carbon retrofits
- to inform housing stock management decisions.

Why is it an issue?

Many of the current uses of SAP were not its intended purposes: SAP/RdSAP was not developed to be the best it could at performing these functions.

Looking ahead, the relationship between SAP and the following objectives and trends therefore needs to be clarified: the Net Zero Carbon target, energy efficiency objectives, heat decarbonisation, the increasing role of renewable energy, the increasing importance of reducing and managing electrical and thermal demand, the rapid evolution and variation of fuel cost and CO₂ emissions and the wide introduction of smart meters.

Changes to SAP can be developed more easily once its priority objectives and functions are established. This is one of the main objectives of this report.



SAP and RdSAP were developed over the last 20+ years. The legal obligation for the UK to achieve Net Zero by 2050 and the crucial role of housing justify a reassessment of SAP's key functions (above: CCC Net Zero and Future of Housing reports, 2019)

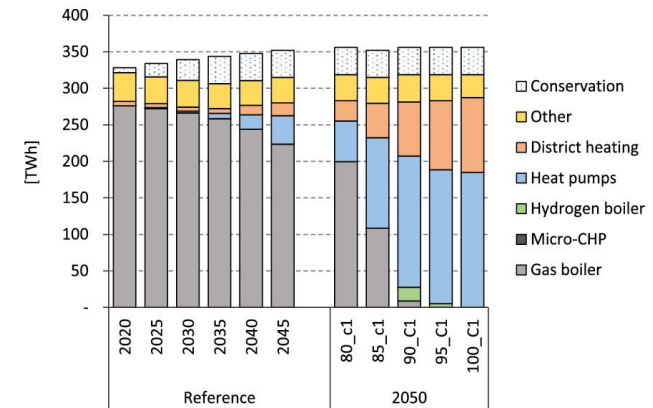

Figure 3. Technology mix for residential heat provision – 80% C1 scenario to 2045 (left); and under five levels of climate ambition for 2050 (right). Broad et al. 2020.

The heating systems required to meet Net Zero Carbon are radically different from those that some key metrics in SAP (e.g. the SAP score) currently incentivise. If SAP is to help achieve the Net Zero objective, this should change.

SAP is misused and not considered a high quality energy tool in the industry, leading to poor quality input

What is the issue?

SAP/RdSAP have become more and more embedded in planning policy and practice beyond Building Regulations in the last 10-15 years. For most new residential schemes the only energy modelling done during the design process is through SAP. The key energy-related drivers for developers and housebuilders are typically how the project performs at planning, at the end of the design for Building Control, and on completion in terms of EPC rating – all calculated by SAP.

The situation is similar in existing homes: SAP/RdSAP represents the only energy or design calculations on most retrofits, and with EPCs the only analysis of energy performance that homeowners and tenants see when considering a new home.

SAP/RdSAP is therefore *de facto* the only housing energy tool in all but rare exceptions (e.g. Passivhaus projects use PHPP to drive their design, with SAP typically used for regulatory compliance only).

Unfortunately, because of the disconnection between the original purpose of SAP (i.e. normalised energy costs) and its perceived purpose (i.e. evaluation of energy use) the industry has been iteratively learning how to get a better SAP rating, rather than learning how to reduce energy use from buildings. SAP has therefore become a misunderstood and misused tool.

While audit checks are carried out, and the quality of information may improve in the future, currently some users do not even feel the need to treat data entries seriously and accurately. Some of this relates to systemic issues, but it is compounded by the fact that SAP/RdSAP outputs are often not considered meaningful and accurate by users, creating a vicious circle where SAP can be reduced to a means for compliance only, with results that are not representative of the dwellings' design and construction.

Why is it an issue?

Design and construction decisions are taken based on the results in SAP, for example, decisions on fabric enhancements and whether to install Mechanical Ventilation with Heat Recovery (MVHR). The misuse of SAP/RdSAP with poor quality data entries and a culture of 'gaming the calculation' lead to the wrong decisions and outcomes. The importance of SAP/RdSAP and its use for design and construction decisions for new and existing homes should therefore be accepted and integrated in the SAP/RdSAP 11 development process.



Extract of the London Plan – policy S12: SAP is used to verify a new building compliance against carbon reduction targets at the planning stage. Its outputs are considered by these policies and processes as accurate prediction of energy uses for space heating, hot water, etc, to be verified against at the in-use stage, which is not what SAP was originally developed for.



A new building optimised using SAP may have intermittent or permanent extract ventilation (© Vent-Axia)



A new building optimised using predictive modelling or in-use performance feedback would have MVHR (© Zehnder)

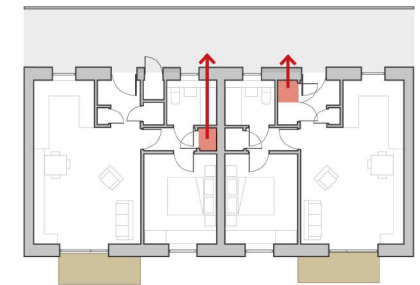

The location of MVHR is not a SAP input, despite the fact that it will impact on the dwelling's energy efficiency: longer duct runs (dwelling on the left) will increase heat losses, compared to an MVHR location near the external wall (dwelling on the right) (© Levitt Bernstein)

Examples of important design decisions which are not considered or even can be influenced negatively by SAP results: Mechanical Ventilation with Heat Recovery (MVHR) and its location in the dwelling.

Building shape is another fundamental design decision (see page 32).

SAP/RdSAP and EPCs do not drive low carbon retrofits

What is the issue?

There are two main issues specific to SAP/RdSAP for existing homes and retrofits:

- EPC ratings are generated by SAP/RdSAP but do not necessarily drive reductions in energy use or carbon emissions. The EPC rating (or Energy Efficiency Rating, EER), is a measure of energy running costs, not of energy use or carbon emissions.
- Whole-house and 'deep' low carbon retrofits are not encouraged, because they are not appropriately assessed and rewarded through SAP/RdSAP.

EPC ratings from SAP/RdSAP do not drive the right outcomes

An important function of SAP, and the original purpose of RdSAP, is to produce EPCs. The current EPC rating is a significant issue and is often misunderstood: many organisations use it as a carbon indicator for the housing stock, with decarbonisation objectives expressed as EPC rating targets. This does not lead to the right energy and carbon outcomes e.g. it can encourage gas boilers over heat pumps. It has been particularly problematic for the last five years as electricity is now a lower carbon option than gas, but is still more expensive.

Available in-use data also shows little improvement in energy use of existing dwellings with better EPC (EER) ratings. There are a number of reasons, including the accuracy of input data but also the methodology itself.

SAP/RdSAP do not show the way and reward whole-house retrofits

SAP/RdSAP does not provide a sense of direction towards Net Zero and a possible 'end goal' in energy and/or carbon performance (potentially phased over time).

The current performance is also not assessed accurately enough (e.g. airtightness is not an input in RdSAP) and therefore possible improvements can be ignored as retrofit options.

In addition, SAP/RdSAP does not apply a whole house approach: works to one element can be assessed as beneficial for regulatory compliance or EPC ratings, without considering interactions with other elements. This does not maximise opportunities to combine measures and does not ensure that works are 'Net Zero Ready' (admittedly, this is more an issue with Part L than SAP).

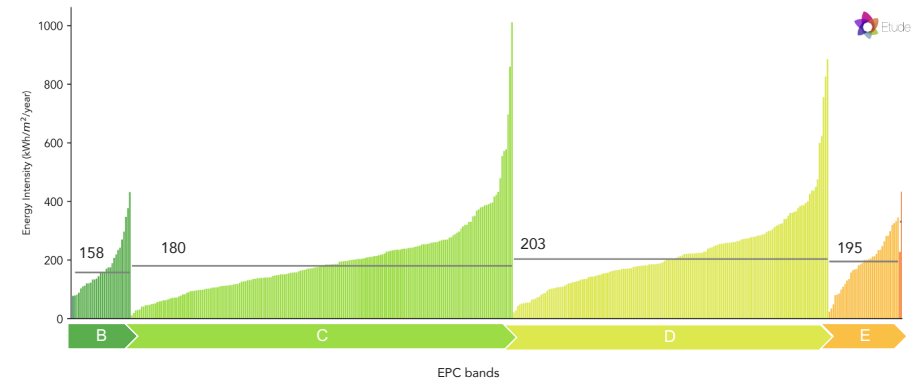

Distribution of metered energy use from 420 dwellings in London

It shows that improved EPC ratings are associated with some reduction in average energy use, but these reductions are far from sufficient to meet the Government's objective of a 50% reduction by 2030. For example, there is only a 22% reduction in total average energy use intensity from D- to B-ratings.

A larger study for BEIS, not yet published but carried out over more than 450,000 homes, shows similar findings (UCL, 2019). For example: for gas, there is a 37% reduction in mean electricity use from D to A, and 26% from D to B; for electricity, there is a 21% reduction in mean electricity use from D to A, and 14% from D to B. The mean total energy use* in EPC band A is 161kWh/m²/yr i.e. over twice the estimated goal of 73kWh/m²/yr for new buildings to meet the 50% objective (GCB, 2019).

* approximated as the total of the means in gas and electricity uses

Whole house or holistic? Terminology used in this report

'Whole house' retrofit often has varied meanings. We have used the following:

- **Whole house:** encourages energy measures to be considered together and in the long-term – as opposed to elemental and short-term
- **Holistic:** considers a range of building performance issues e.g. comfort, air quality – as opposed to focused on energy performance alone

SAP/RdSAP metrics are misaligned with key Government objectives and are not user focused

What is the issue?

The main metrics currently used by SAP/RdSAP are:

- **Carbon** : Dwelling Emission Rate (DER) and how it relates to the Target Emission Rate (TER). This is the main metric for compliance with Part L.
- **Energy costs**: SAP rating, also called EPC rating, or Energy Efficiency Rating (EER): this is an energy cost indicator.
- **Fabric Energy Efficiency**: Dwelling Fabric Energy Efficiency (DFEE) and how it relates to the Target FEE.
- **Primary energy**: this is proposed to be the new main metric in SAP 10.

There are two types of issues with these metrics : the metrics themselves, and their hierarchy. The latter has been changed in the Part L 2020/FHS consultation: carbon used to be the main metric for compliance with Part L, but this is set to become primary energy in SAP 10, with carbon and FEES as secondary metrics.

Why is it an issue?

The metrics in SAP/RdSAP are not optimal as they are not aligned with the main Government objectives (carbon and energy efficiency) and cannot easily be verified by users, preventing a feedback loop and continuous improvement.

They are generally not straightforward to non-specialists: primary energy for example means little to most people, and probably never will.

SAP/RdSAP outputs are also expressed as relative targets (e.g. % improvement over Part L) and not absolute ones. It is possible for a dwelling to have higher energy use or carbon emissions per sqm than another, but be assessed by SAP/RdSAP as 'better'. This adds unnecessary complexity and confusion, and does not support objectives of energy efficiency and decarbonisation.

The metrics also do not directly relate to how a building performs in-use, therefore once a home is occupied it is impossible to understand whether it performs as intended: **primary energy, carbon, and energy costs all depend on the wider system rather than addressing the building performance itself and alone.** If the metric relies on system factors, these must be updated regularly, otherwise they become out-of-date and potentially lead to the wrong outcomes. This has been the case for more than 5 years with SAP 2012 and its out-of date carbon factor.

		Carbon Emission Reductions				EUI kWh/m ²
		Building Regs	SAP 10	Sap 10.1	Lifetime	
Fabric & Ventilation	Business as usual	18%	59%	75%	88%	56
	Ultra low Energy	40%	70%	83%	90%	33

Building Regulations compliance and planning policy for carbon reduction is currently based on the SAP-calculated percentage improvements over Part L. Unfortunately when carbon factor changes, these change as well, without any actual reduction in energy use of the building. This creates confusion, a misunderstanding of the energy performance of a building, and possibly wrong outcomes.

Policy objectives – would the metric incentivise...

Metric ↓	reduction of carbon emissions?	reduction of energy use?	low-carbon heat?	demand reduction / flexibility?	renewable energy generation?	consumer awareness?
Carbon [kgCO ₂ /m ² /yr]	✓	~	✓	✗	✓	~
Energy use [kWh/m ² /yr]	~	✓	✗	~	~	✓
Primary energy use [kWh _{pr} /m ² /yr]	✗	~	✗	~	~	✗
Peak demand [kW/m ²]	✗	~	✗	✓	~	~

Summary comparison of possible metrics: it is clear there is not one metric which can incentivise all policy objectives: Energy use (kWh/m²/yr) is probably the best one but it should be completed by others, especially for heat decarbonisation. Additional metrics can be considered relating specifically to heating demand and fabric performance (e.g. Fabric Energy Efficiency, Heat Transfer Coefficient, space heating demand). See additional analysis on p. 41.

The approach based on a Notional Building with a relative target is detrimental

What is the issue?

In England and Wales, Building Regulations are required to achieve 'minimum energy performance requirements in the form of target CO₂ emission rates' (Regulation 25). The methodology and target are defined by the combination of the Approved Document (or equivalent in the devolved nations) and SAP, including Appendix R which details the reference values for the notional dwelling: SAP is therefore intrinsically linked to the targets that new dwellings or works to existing dwellings (where applicable) have to comply with, through the calculation of the performance of notional dwelling.

This approach has two significant drawbacks:

1. The **setting of the notional building**, in particular the fact that it has the same shape, orientation and, up to a point, glazing proportions as the actual building.
2. The **approach based on relative performance** compared to the notional building instead of an absolute performance level, which creates confusion and makes a post-construction verification and feedback loop more complicated.

Using a notional dwelling was known to have drawbacks when it was introduced in 2006, but on balance it was adopted given objectives at the time. 15 years on there is a significant consensus in the industry that the issues it creates now outweigh the benefits. One of the main justifications for the notional dwelling approach is that it deals better with exceptions, but exceptions should not dictate the rule and they could be dealt with through other means..

Why is it an issue?

Improving the design of a dwelling by reducing the extent of heat loss areas and the number of junctions and by distributing glazed areas with consideration of solar gains are widely considered as three essential components of an energy efficient design. The notional building almost neutralises most of these measures: it does not reward efficient designs.

In addition, a relative performance assessment has a number of issues: it is not a 'physical' metric, it cannot be checked by the occupant during operation and therefore it cannot be used to 'close the loop' and inform the development of SAP through in-use data. Finally, a relative target is not the most effective way to drive towards an absolute objective: Net Zero.

SAP version 10.1 (September 2019)

Appendix R: Reference values

Table R1 : Reference values for target setting
(Option 1 and option 2 relate to levels being consulted on for possible use in Building Regulations.)

Element or system	Option 1	Option 2
Climate data	UK average	
Size and shape	Same as actual dwelling	
Opening areas (windows, roof windows, rooflights and doors)	Same as actual dwelling up to a maximum for total area of openings of 25% of total floor area. If the total area of openings in the actual dwelling exceeds 25% of the total floor area, reduce to 25% as follows: 1) Include all opaque and semi-glazed doors with the same areas as the actual dwelling (excluding any doors not in exposed elements, e.g. entrance door to a flat from a heated corridor). 2) Reduce area of all windows and roof windows/rooflights by a factor equal to [25% of total floor area less area of doors included in 1)] divided by [total area of windows and roof windows/rooflights in actual dwelling].	

This extract from Appendix R (SAP 10.1) shows that the shape of the dwelling, and to some extent the proportion of windows, are replicated in the notional building. This hides their effect on performance, and disincentives attention to these important design factors.

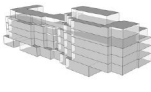
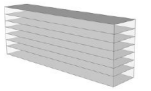
		Improvement over Part L (%) SAP	Space heating demand (kWh/m ² /yr) SAP	Space heating demand (kWh/m ² /yr) PHPP
High form factor		35%	18	26
Medium form factor		35%	15	20
Low form factor		37%	11	13

A more efficient form is important for low energy buildings, but it is not rewarded by the notional building approach: With similar specifications (e.g. U-values) the Part L % performance calculated by SAP for the three buildings above is broadly similar despite the space heating demand calculated by PHPP being up to 50% smaller with a more efficient design.

SAP under-estimates space heating in new dwellings

What is the issue?

On average, at stock level, our analysis of available data indicates that SAP-calculated energy use for space heating and hot water is around 20% lower than actual energy use. The discrepancy is particularly significant for flats (28%) but is also true for houses (18%). This can be obtained via EPC statistics reports, and compared with what is known of energy use across the building stock from Ofgem and from a large data analysis project by UCL for BEIS (BEIS, 2019). The comparison is necessarily high-level as it includes a wide range of typologies, and relies on other factors such as quality of data inputs, but it has the benefit of giving a stock level viewpoint.

Comparative SAP/PHPP modelling undertaken on new blocks of flats supports this by showing a discrepancy of up to 45% for space heating.

There are different reasons explaining this issue, including the use of a normalised location, the significant over-estimation of internal heat gains, or the under-estimation of heat losses from thermal bridging.

Why is it an issue?

The under-estimation of space heating is detrimental as it leads to under-estimating the potential benefits of measures to reduce space heating demand (e.g. better U-values, triple-glazed windows, more airtight dwellings). As a consequence, homes are built that use much more energy than they need to.

In fairness, SAP was not developed for the purpose of evaluating energy use accurately. However, if the strategic objective of SAP is now to drive energy efficiency, it is important that SAP becomes much better at this.

It would then naturally give more importance to performance in use rather than theoretical SAP results, and a feedback loop could be created to enable SAP to gradually become better at predicting actual energy use.

Whilst there are necessarily variations at building level due to occupancy, more accurate calculations are possible, both at the building level and at stock level.

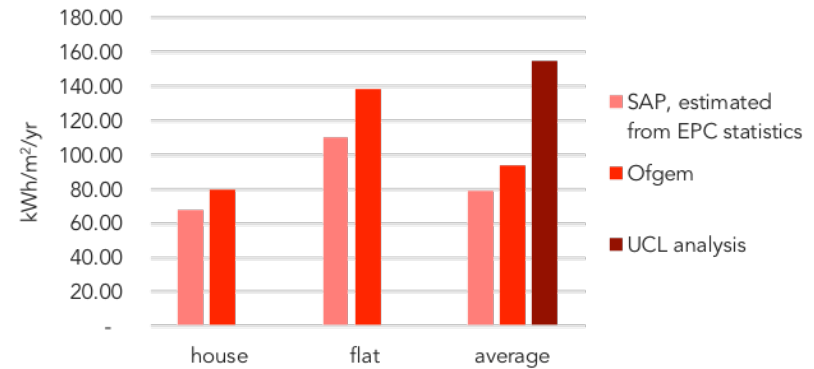

For new dwellings, energy use for space heating and hot water calculated by SAP* is on average lower than actual gas use. There is not easy direct comparison due to the information available and the nature of EPC ratings, but our analysis provides a comparison with two sources (average gas consumption data from Ofgem, and a large analysis of in-use energy data per EPC ratings by UCL (2019)). Both lead to that same conclusion. This appears to be particularly the case for flats.

* as estimated via fuel costs stated on EPCs

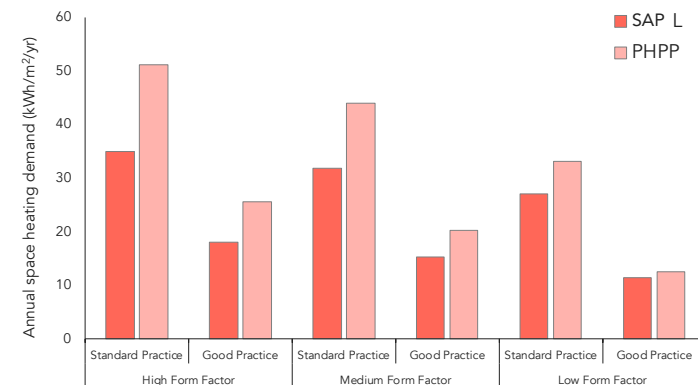

For a block of flats, the above bar chart indicates that space heating demand estimated by SAP is always lower than from PHPP, with the discrepancy ranging between 15 and 45%.

As PHPP has been shown to give average predictions very close to actual space heating demand (Johnston et al, 2020), this suggests that SAP under-estimates space heating demand for this typology.

The 'static' carbon number is quickly out-of-date and fails to reward smart controls and technologies

What is the issue?

SAP is using an average carbon emission factor for electricity, based on a prediction for the forthcoming 3-5 years each time SAP is updated (e.g. 2020-2024 for SAP 10). Therefore, the estimate of a dwelling's carbon emissions only reflects the short term, despite the fact that new dwellings will continue to emit emissions virtually unchanged in the medium to long term. The issue is compounded by the fact that any delay in the update of SAP leads to a significant problem. SAP was last updated in 2012, with a carbon factor for electricity of 519 gCO_{2e} per kWh based on the average projection for 2013-2015. It is still used today, but the actual emission factor for the last 12 months in 2020 is actually 169 gCO_{2e} per kWh: **more than three times lower!**

The draft SAP 10.1 introduces monthly carbon factors which is interesting but unfortunately it follows a similar approach. The equivalent proposed annual average carbon factor only represents the average for the period 2020-2024: 136gCO_{2e} per kWh. **This will again not be representative of average emissions over the next 20-30 years and will be quickly out-of-date.**

A separate issue is that electricity is generated by many different sources, and the 'grid mix' constantly changes each hour, each month, and regionally. The dynamic nature of electricity generation needs to be examined as 'smart' technologies will seek to better integrate dwellings in tomorrow's energy system by shifting electricity use to coincide with periods of cheap low carbon generation.

Why is it an issue?

The use of a short-term average is only valid for fuels with a fairly stable carbon factor. For electricity, it is not a fair representation of expected emissions over the next 20-30 years. The short rather than medium-long term impact of decisions is evaluated, which is a very significant issue.

In addition, SAP may be at risk of failing to show the benefits of important technologies such as demand-side response and energy storage. The ability to reduce and shift demand to a different time of the day is very likely to become very important in the next few years.

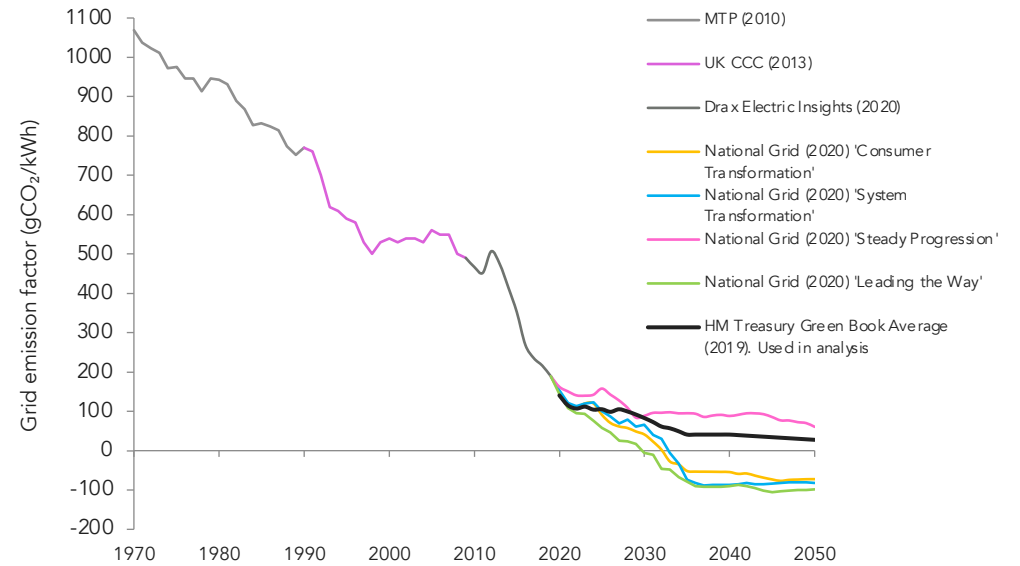

Long-term variations in emission factor of grid electricity show the rapid historical reduction in emission factors. Using short term carbon factor for electricity fails to represent the true lifetime emissions of a home. © Etude based on data from Market Transformation Programme, UK Committee on Climate Change, Drax, National Grid and HM Treasury.

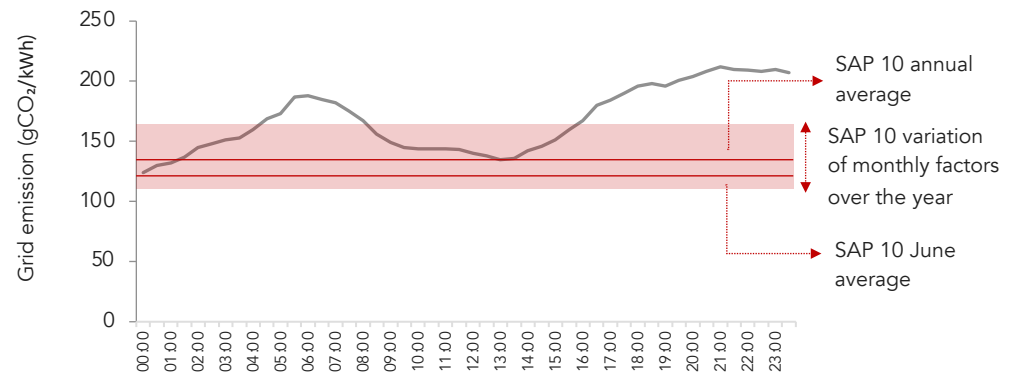

The grid emission factor varies over the day (example above for 1st June 2020). Solar electricity generation during the middle of the day can reduce it, and the evening peak is caused by additional demand met by fossil fuels. There is around a two-fold variation over that particular day (from 124 gCO_{2e} up to 210 gCO_{2e} per kWh), but each day is (very) different. This is shown here against SAP 10 factors under a standard tariff, for comparison. (Data reference: National Grid ESO Carbon Intensity API, <https://carbonintensity.org.uk/>)

Accuracy and consistency: the status quo needs to be challenged

What is the issue?

A number of criticisms of SAP, and particularly those associated with its lack of accuracy are at least partially unfair: the accuracy of SAP was reduced on purpose due to the need to assume normalised parameters and set consistent standards. For example, the location for a SAP assessment was normalised to one location (East Pennines) so that higher standards of insulation would not be required for a new house in Aberdeen compared to one in Brighton. This approach is now an issue and needs to be challenged.

As these concepts of consistency and accuracy are so important to inform the development of SAP/RdSAP 11, we have sought to define them:

- **Accuracy** can be defined as the degree to which the prediction made by SAP/RdSAP is close to actual performance once the dwelling is built. There are two main accuracy issues to review in the current SAP: whether inputs, assumptions and calculations lead to an accurate representation of the average home; and whether they are adjustable to be accurate for specific homes.
- **Consistency** can be defined as the result of the normalisation process to ensure that SAP/RdSAP can be used for a regulatory purpose. So far, this concept applies to the underlying assumptions (e.g. occupancy, location, etc.), which results in consistency of design and construction measures (e.g. the level of insulation required). However, this means consistency of performance outcomes (e.g. energy use) has not been a priority, which is a key issue.

Why is it an issue?

Consistency of construction standards has been favoured so far but Net Zero changes this. Science-based targets focus on outcomes and the legal commitment for the UK to achieve Net Zero relies on achieving these outcomes. Net Zero therefore gives much greater weight to accuracy and consistency of energy performance outcomes. The reason for this is simple: a house is or is not Net Zero Carbon. As Net Zero Carbon needs to be delivered in Aberdeen as well as in Brighton, SAP/RdSAP 11 should be more accurate and more focused on performance outcomes.

It is also clear from our review of policies and the new landscape that improving the ability of SAP/RdSAP to evaluate energy use more accurately must become a key priority, even if some degree of normalisation is expected.

	Current priorities in SAP: more consistency for design and construction measures	Recommended priorities: rebalancing towards more accuracy, adjustability and consistency of performance outcomes
Location*	One location (East Pennines)	Regional location
Carbon factor*	Single set of carbon factors for the UK	Different set of carbon factors, at least per nation (especially Northern Ireland)
Occupancy	Standardised occupancy	User can specify occupancy (possibly outside of regulatory purposes**)
Heating	Standardised set point	User can specify set point (possibly outside of regulatory purposes**)
Hot water*	Standardised hot water use (l/p/day)	User can specify flow rates of fittings
Unregulated loads, and associated heat gains*	Standardised	User can specify internal equipment (even if it remains unregulated)
In-use factors	Standardised to account for 'average' performance gap	User could be able to change them if a certified quality assurance process is used (possibly outside of regulatory purposes**)

The table provides a list of parameters for which a different decision may be required to improve the accuracy and consistency of performance outcomes in SAP/RdSAP 11.

It is important to distinguish the parameters which are by nature difficult to predict accurately and for which a standardised prediction is unavoidable (e.g. future occupancy) and the parameters for which more accuracy is possible (marked with a *).

** one of our recommendations is to enable SAP to be used for other purposes than regulatory compliance – see Section 4.

SAP is stifling industry-led innovation with the current Appendix Q and PCDB process

What appears to be an issue?

The SAP Appendix Q database aims to validate individual branded product performance information and make them directly accessible within approved SAP softwares. Products listed in Appendix Q may be migrated to the Product Characteristic Database (PCDB) when a new version of SAP is released. In short, the differences between the PCDB and Appendix Q are:

- Appendix Q is usually the first step. It provides an external 'bolt-on' calculation such as a spreadsheet, and its products are not available for use in RdSAP
- PCDB technologies and products are directly selectable within SAP and RdSAP.

They therefore play a crucial role in the respective technology markets.

A product's performance is determined by testing it against a specification or calculation methodology that has been agreed by BEIS's NCM contractor (BRE), the relevant manufacturer(s) and/or industry sector representatives. Manufacturers of new technologies who wish for their products to be included in Appendix Q or the PCDB must undergo an extensive multi-stage application process that can typically take 1 to 2 years and be costly. If a technology category already exists in Appendix Q or the PCDB, manufacturers can submit an application to add a new product to one of these categories, with laboratory test data.

The transparency and cost of the above processes, as well as their consideration of field data could be improved.

Why is it an issue?

Although a robust and fair system needs to be maintained when accounting for new technologies in SAP, the extensive administration, cost and timescales may discourage the inclusion of new technologies to all but very large companies who have the resources to make the application. SAP is so embedded in the housing sector that this can overall hinder market adoption.

At a time when a number of 'mini-revolutions' are currently taking place (e.g. new heating systems, smart technologies), the process of application and approval presents a high risk of preventing or slowing down the adoption of many innovations. A more accessible system that seeks to overcome the above should be investigated. In addition, the process should be more flexible to in-use performance data and make better use of it, to supplement the initial lab testing.

SAP 2005	SAP 2009	SAP 2012 / SAP 10
Decentralised Mechanical Extract Ventilation (rigid and flexible ductwork)	Storage Waste Water Heat Recovery System (WWHRS)	-
Centralised Mechanical Extract Ventilation	Solar Air Positive Input Ventilation (PIV)	
Mechanical Ventilation with Heat Recovery (MVHR)	Dynamic Insulation	
Flue Gas Heat Recovery System (FGHRS) and Passive Flue Gas Heat Recovery System (PFGHRS)	Solar Assisted Heat Pumps	
Heat Pumps		
Instantaneous Waste Water Heat Recovery System (WWHRS)		

Available technology categories in Appendix Q. Products shown in red cells have been moved to the PCDB, as of SAP 2012 or SAP 10.

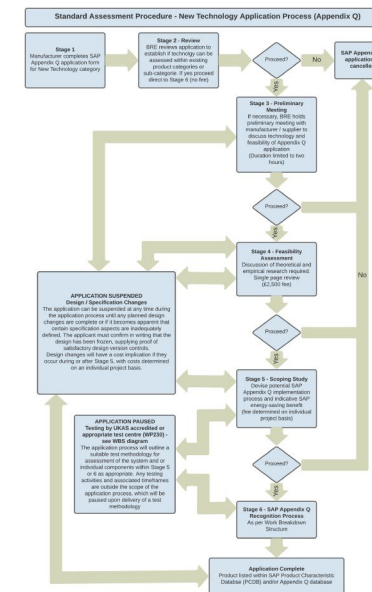

Appendix Q application process

SAP/RdSAP does not get the funding (and therefore resources) it deserves

The crucial importance of SAP and RdSAP

How do we estimate the energy and carbon performance of our new and existing homes across the United Kingdom? With SAP and RdSAP. These methodologies are therefore of critical importance to the delivery of housing and of our climate change objectives. Their economic role and impact is also very important:

- They are driving the design, specification, procurement and construction of **between 100,000 and 180,000 new dwellings** a year. This represents a huge market (£38bn in 2018 for England and Wales only).
- They inform the choices of **hundreds of thousands of homeowners and landlords about the retrofit of their homes**, either directly or through their influence on products available on the market. The recent announcement of the £2bn Green Homes Grant scheme provides an indication of the huge market influenced by SAP/RdSAP, and this scheme in itself would only capture a very small proportion of existing homes. The Construction Leadership Council (CLC) estimated the market to represent **£525bn over the next 20 years**.
- They impact on **energy bills and fuel poverty**: social housing tenants spend **£4.2bn a year on energy**.

SAP /RdSAP does not get the funding (and resources) they need

The annual expenditure on the development of SAP and RdSAP and its continuous improvement represents a small budget which, in our view, is disproportionately low when compared with the scale of the markets it influences and the importance of the policy objectives it needs to support. Government investment is particularly important in the housing and retrofit sector as consumer protection is particularly critical and companies often operate with smaller profit margins and/or resources which limit their capacity to invest in these tools themselves.

It is obviously not only about funding, but we understand that this has put a constraint on the development of SAP/RdSAP, which must be addressed. The economy as a whole would benefit from more investment into a better SAP/RdSAP: it would drive better decisions, better allocation of resources and funding and better outcomes. And it could be funded through a small £5 levy on each EPC. To achieve Net Zero and do it in the most economic way possible, SAP/RdSAP should be enabled to play a bigger and better role.



SAP is being used on each and every one of the 100,000-180,000 new dwellings being built each year in the UK

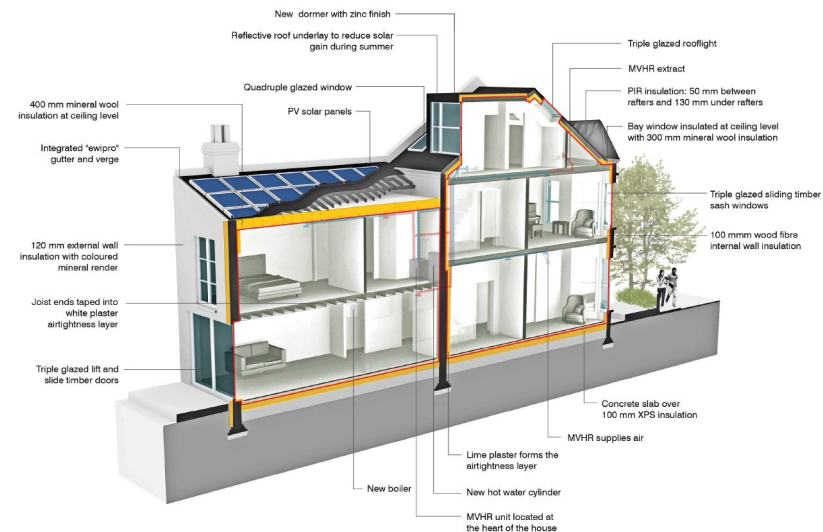

Example of a retrofit strategy for a single home showing the wide range of products used in a retrofit. The size of this market is significant and is likely to be an important area of growth in the future (© Arborea)

Summary | Current assessment of SAP/RdSAP against desired policy outcomes

Policy objective	SAP/RdSAP performance against this objective	
Net Zero Carbon by 2050	X	<p>Poor</p> <ul style="list-style-type: none"> SAP uses primary energy and carbon as key metrics for Part L compliance. However, it uses short-term factors which do not reflect forward-looking scenarios for the electricity grid and can be rapidly (and considerably) out of date. SAP only considers regulated energy uses, not all energy uses. It uses a relative target set by comparison with a notional building, not an absolute target. The nature of the Net Zero Carbon target is 'absolute'. The EPC rating, the main metric used in policy to drive the decarbonisation of the housing stock, is an 'energy cost' metric. EPCs include a rating related to carbon (the Environmental Impact Rating – EIR), but it is only for indication, not the basis of policy objectives. This has become all the more a problem in recent years as electricity has become lower carbon, but remains more expensive than gas.
<p>Improving energy efficiency and reducing demand</p> <p>New and existing homes</p>	~	<p>Partial</p> <ul style="list-style-type: none"> Energy use is not a key metric in SAP, neither in Part L targets nor in EPC ratings. SAP produces a Fabric Energy Efficiency (FEE) metric to express thermal demand related to fabric performance. MHCLG have confirmed in their January 2021 response to the consultation on Part L and the Future Homes Standard (FHS) that it will be retained, or another form of fabric/heating metric. This is positive however, FEES do have limitations: they are based on a theoretical assessment which cannot be verified as-built or in-use, and they provide an assessment against a notional dwelling, not an absolute picture of fabric performance. Primary energy is proposed as a new main metric in SAP 10 and the FHS. This is not directly verifiable (as it involves conversion factors) and means little to consumers or the industry. It can also encourage the use of fossil fuels such as gas, compared to electricity. It should not become the main SAP 11 metric. SAP considers regulated energy use only. Unregulated loads (e.g. cooking, appliances and equipment) are however becoming a significant part of the energy consumption of homes; they also influence internal gains, and with the introduction of electric storage and other demand management measures, the distinction between regulated and unregulated uses may become more blurred. The evaluation of energy use is not accurate (e.g. location is normalised to a single location – East Pennines). The evidence shows only limited relation between EPC ratings and energy use, and the energy savings from improved ratings are small. On existing homes, opportunities are missed as SAP/RdSAP does not provide a comprehensive assessment of possible improvements e.g. measures that would go well together, an end goal, and a comprehensive range of measures (including airtightness, not considered in RdSAP).
Heat decarbonisation	X	<p>Poor</p> <ul style="list-style-type: none"> The Fabric Energy Efficiency (FEE) metric in SAP expresses thermal demand related to fabric performance, and could be useful. However, it does have limitations (see above), while other metrics such as space heating demand or Heat Transfer Coefficient provide a more direct and/or verifiable metric. SAP 10 proposes that the notional building, which sets the carbon emissions target, is gas-heated. It does not encourage the transition away from fossil fuels. It also means that the target is less onerous for homes with heat pumps. An electric heated building with a medium performing heat pump achieves 60% carbon emissions reductions, just from switching to a heat pump. This means that any improvements in fabric or additional renewable energy generation on-site are not encouraged. SAP 10 provides an improved but not sufficiently robust assessment of heat networks, in particular distribution losses and their long-term generation mix. This allows higher emissions, prevents like-for-like carbon comparison with other heating options, and does not support long-term plans for decarbonisation. (The proposed additional 45% allowance ('technology factor') for buildings linked to heat networks with CHP will not be implemented, which is positive).

3.0

What can we learn from others?

This section summarises the outcome of our:

- Literature review
- Review of the SAPIF report
- Engagement with experts
- Review of other energy models across the world

Literature review

Overview of the approach

A literature review has been carried out, which covers several areas:

- **Analysis of SAP in its current and previous iterations**, including topics such as comparisons with in-use performance (e.g. BPN State of the Nation report).
- **Other methods in Europe and across the world**: particularly useful references for this are the AECB, and the 2016 *Review of Global Best Practice* report.
- **Housing trends**: these have been incorporated in the landscape review (section 1). A particularly useful reference is the Design Council's *Home of 2030* report.
- **Technology trends**: these have been incorporated in sections 1 and 4. A particularly useful reference is the SAPIF report.

A selection of main references is provided at the end of this report. They should add to the evidence base behind the development of SAP and RdSAP 11.

Key findings

The literature review has informed all aspects of this report: the landscape review, what we can learn from others, and the recommendations. Key findings include:

- The **discrepancy between calculated and actual energy use**. The literature points to huge variations due to household-specific factors, and the need for much more in-use monitoring and data.
- **The importance of metrics and the limitations of using a single one**, with in-use energy and space heating increasingly favoured as they create a better link to consumers and reflect what can most be acted on through the building itself;
- **The growing consensus that using a notional building to set targets is insufficient and even detrimental**.
- **Simplicity is essential to minimise user errors and maximise ownership by users**. This is likely to far outweigh possible gains through increased sophistication.
- **There is no irreconcilable difference between SAP and PHPP**. A higher level of accuracy and functionality in SAP is considered possible without a fundamental change to the method.
- **There is a need to better integrate future technologies and demand management in SAP/RdSAP**.

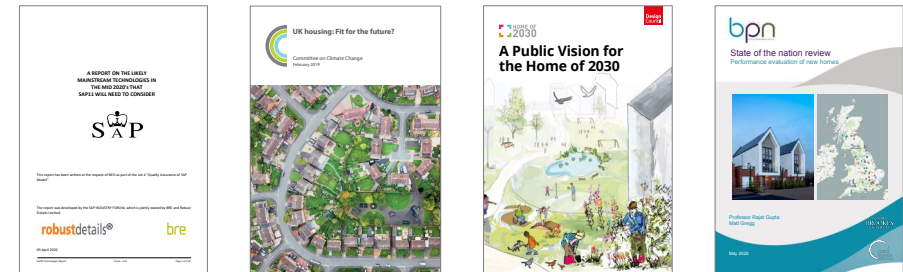

A selection of reports included in the literature review, to inform landscape trends – policy, housing and technology

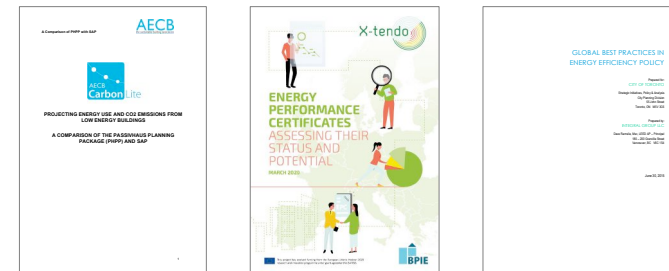

A selection of reports and papers included in the literature review, to inform the review of other energy models

Recommendations for further literature review and research, to refine the current recommendations and contribute to the continuous development of SAP:

- Occupancy density and patterns across the 4 nations: average, distribution (a very initial review has been carried out but needs more in-depth work)
- Unregulated loads and occupants: influence on regulated loads and total energy use, and influence of sample size (when do averages become representative?)
- Energy use for hot water, how it compares with SAP, sources of inaccuracy and potential solutions (initial recommendations are included in this report). This could be linked to the work of water utilities on water use and the impact of Building Regulations (including the optional standard).
- In-use monitored track-record of energy models (an initial review has been carried out but further data may become available in the future)
- Reporting on “smart” buildings, especially demand reduction and demand management potential.

The SAPIF report on technologies

The SAP Industry Forum (SAPIF) has been created to enable industry to feed in and discuss their views on the development of SAP. It is an advisory group and is different to the SAP Scientific Integrity Group (SAPSIG) which aims at maintaining and protecting the integrity, coherence and impartiality of the SAP model. SAPIF members include the BRE, Robust Details, trade associations and suppliers.

The SAP 11 Technologies report, its importance and limitations

In April 2020, SAPIF published a report on the likely mainstream technologies in the mid-2020's that SAP 11 will need to consider. It provides details of the expected technologies, relevant standards, sources of performance data and suggested ways to model the technologies.

It is one of the key reports which should be used to inform the development of SAP/RdSAP 11. Its individual descriptions of technologies are particularly useful. However, it should also be noted that the SAPIF report is essentially the sum of the work of five different working groups. The opinions and recommendations of those different working groups are sometimes contradictory and the SAPIF report does not seek to reconcile some of these views.

Key points

Smart technologies and load shifting. SAPIF recommends that SAP should seek to model these technologies and this is one of the main points highlighted in the report. It points out that there are currently high barriers to entry and that it is difficult for an innovative product to be recognised and rewarded in SAP.

Dynamic modelling. A recommendation which is repeated throughout the report is to move away from steady-state monthly energy modelling to dynamic half-hour modelling. However, SAPSIG noted in their review of the report that there are PROs and CONs with this move.

Hot water. SAPIF recommends an improvement in how hot water demand is modelled as it is considered too basic, as well as an update of the underlying data.

Overheating. The report recommends that SAP should be used for a simple initial overheating check with specialised tools used for a detailed assessment.

Process and quality. SAPIF and SAPSIG both express a concern over the poor quality of data being entered into SAP.

Working Group 1 - Domestic Hot Water (DHW) and heating

The report provides details on DHW consumption by use and recommendations to improve its calculation in SAP. It considers technologies such as demand side response for heat and DHW, peak shaving and load shifting using DHW storage as well as options to better use local generation to improve self-consumption. It indicates that Appendix Q and its process represents a high barrier to entry, stifling innovation.

Working Group 2 – Smart technologies

The working group considered smart controls for heating systems, demand side response technologies and flexible tariffs. The working group highlights the potential for these technologies to save carbon through load shifting and increased self-consumption of on-site renewable energy. Although electric vehicle charging was specifically excluded it is highlighted as significant consideration.

Working Group 3 – Energy storage

The working group considered thermal energy storage (e.g. DHW tank) and electrical storage solutions (e.g. batteries). The summary points out that SAP would need to cover unregulated energy use to appropriately assess their benefits. It highlights the challenge that technology advances quicker than SAP updates are implemented. It also refers to the EU Smart Readiness Indicator (SRI).

Working Group 4 – Overheating and cooling

The report focuses on the 'technologies' which help to mitigate overheating: glazing, shading, thermal mass and ventilation. It provides a list of current and emerging technological development, e.g. electrochromic glazing, sensor-controlled ventilation) but also points out at particular limitations of SAP as it is, e.g. consideration of thermal mass.

Working Group 5 – Ventilation and Indoor Air Quality (IAQ)

The working group considered different ventilation systems and how they are modelled in SAP. It established that continuous ventilation does not receive any significant benefits in SAP, partially because of the way intermittent extract ventilation is favourably modelled. It also reviewed different control systems.

Learning from experts

Building on the huge knowledge acquired over the last 30 years

As part of this SAP/RdSAP 11 scoping project, we have engaged with a number of experts: people who have been directly or indirectly involved in the development of BREDEM, SAP or RdSAP, people who are at the heart of the software solutions using these methodologies and the assessors using their software, and people who have had to consider SAP in a lot of detail through their policy work, research and analysis, at the building or at stock level. We are very grateful to all of them and their names can be found on page 5 of this report in the 'Acknowledgments' section. They have explained why and how BREDEM, SAP and RdSAP have evolved over time and why some choices have been made in terms of type of modelling (e.g. steady-state vs dynamic) or approach to the tension between accuracy and consistency.

These exchanges have influenced the 25 recommendations summarised in section 4. Although some points of views differed, a consensus appeared on some key principles:

- BREDEM, at the core of SAP, is a reasonably good calculation methodology.
- There will always be a tension between accuracy and consistency, but improvements to accuracy are possible.
- SAP should remain simple as it is used by a wide range of people.

Being ready to make new choices

Understanding the evolution of BREDEM, SAP and RdSAP is necessary but does not mean that significant improvements are not possible. It is important to acknowledge that its development over the last 10 years has happened more on an 'ad hoc' basis rather than led by a strategic vision. **As Government and the wider industry are now seeing SAP as a key tool to help deliver Net Zero Carbon ready buildings and the whole house retrofit of existing homes, new choices, possibly different from the ones made so far, should be made.**

In particular, experts acknowledge the need to predict energy use more accurately, the electricity system revolution and its impact on demand flexibility, the heat decarbonisation priority and the need for SAP to play a role in reducing the performance gap as key reasons for these new choices. The success of SAP 11 will largely depend on the ability to create a new consensus, building on the embedded intelligence while embracing new priorities.



The BRE Domestic Energy Model (BREDEM) is at the heart of SAP and has been developed over the last three decades. Our discussions with experts have confirmed that it is considered to be a satisfactory energy model which should be improved rather than discarded.



The world has changed. Experts acknowledge that SAP and RdSAP 11 should embrace today's priorities which are different from what they were 30 years ago. In particular, the urgent need to put new and existing homes on the right track to achieve Net Zero by 2050 is considered an absolute priority.

It is time to work together: a case study

The need to address climate change and achieve Net Zero has triggered a number of very positive collaboration initiatives. We have selected one as a case study to illustrate their benefits and how useful they can be in the development of SAP 11.

Collaboration between AECB, Passivhaus Trust and Elmhurst

The Association for Environment Conscious Building (AECB), the Passivhaus Trust and Elmhurst Energy have reviewed in detail the calculations and outputs of the Passive House Planning Package (PHPP) and compared them with SAP.

While PHPP allows a user to enter more data in some areas and considers some elements, such as thermal junctions, differently from SAP, they have concluded that the core of the models is very similar. However, as the two modelling systems were designed for different functions, the way in which they are employed, and the scope of their outputs differ. For example:

- PHPP uses local climate data and includes unregulated energy to give an overall assessment of actual energy use.
- In contrast, SAP uses an average location as climate data and excludes unregulated energy.

These three organisations are working to bring together energy professionals from across the sector in order to identify potential improvements to allow a direct and fair comparison between all homes whatever their type or energy performance.

SAP 11 can be a collective ambition and achievement

This collaboration, alongside others on domestic energy modelling (e.g. LETI), and the way this SAP 11 scoping project was run illustrate the benefits of harnessing the diverse expertise of professionals around the UK. It is also very clear from our interviews with experts that after many years of debate on SAP and RdSAP the industry is now reaching consensus on large number of elements, with a view to find a solution.

Working together is therefore imperative to ensure that we have key industry tools that result in more energy efficient, lower carbon and sustainable homes. This will make it easier for all stakeholders including: energy assessors, housebuilders, building control bodies, the supply chain, innovators, and consumers obviously.

We can deliver if we work together towards the same objective.

The objectives of the AECB-PHT-Elmhurst collaboration

1. To learn from the strengths and weaknesses of both approaches, thus improving both.
2. To make it easier to demonstrate compliance for both building regulation purposes and for those that want to build homes that are above and beyond the minimum regulatory standards.
3. To work together to produce a solution that presents key performance data for a property in a clear manner, and giving equal prominence to:
 - Carbon emissions
 - Energy demand
 - Running cost
 - Fabric efficiency
4. At the same time, to provide clarity on the scope of the energy use for:
 - Space heating only
 - Regulated energy
 - All energy use
5. To standardise the units of measurement of a home's performance to allow for direct and fair comparison.
6. To develop a common energy reporting process capable of being driven by either PHPP or SAP as the starting point.

Ultimately all three organisations, and their members, understand that their aims are the same, to facilitate the building of energy efficient homes, and that what are currently considered to be high performing homes will, very soon, become the norm. By working together that goal will be easier to achieve.



Review of best practice building energy models and regulation | Introduction

The purpose of the building energy model review was to learn from best practice policies, regulations, modelling methodologies and voluntary standards across Europe and the world. The approach to the review was based on the hierarchy of policy objectives that SAP/RdSAP should help deliver:

Net Zero Carbon by 2050 **Energy efficiency** **Heat decarbonisation**

To complete this task the following process was developed:

1. A review of **ecosystems** – the European and global best practice regulation, policies and voluntary standards to understand how other countries are delivering Net Zero Carbon.
2. A review of **modelling methodologies** - used in regulatory and voluntary standards.
3. A review of **simulation tools**.
4. An **in-depth review** - to capture best practice in 9 selected ecosystems and modelling methodologies in Europe, together with other relevant standards across the world.
5. Common themes and leading examples have been drawn out from all ecosystems, modelling methodologies reviewed.

The box on the right hand-side provides the list of regulation, policies and voluntary standards that were reviewed as part of steps 1-5.

A summary of the in-depth reviews is provided in this section, with more information outlined in section 7.

Snapshot of long list review summary

Snapshot of in-depth review summary

Europe - Regulatory standards

- Denmark: BR18
- Finland: National Code
- France: RT2020
- Germany: GEG
- Ireland: DEAP
- Netherlands: BENG
- Norway: TEK17
- Spain: CTE
- Sweden: BBR
- Switzerland: SIA 380/1

World - Best practice regulatory standards

- British Columbia Step Code - Energuide Compliance Path (Canada)
- City of Boulder Energy Conservation Code (USA)
- City of Toronto's Zero Emission Building Framework (Canada)
- NatHERS (Australia)
- Seattle Performance Path (USA)
- Title 24 - California (USA)
- Vancouver Zero Emissions Building Plan (ZEBP) (Canada)
- Washington - Appendix Z (USA)

World - Best practice voluntary standards

- Canada Green Building Council (CaGBC) Zero Carbon Building Standard (Canada)
- Zero Code - California (USA)
- ILFI Net Zero Energy (USA)

Europe - Best practice voluntary standards

- DGNB Climate Positive Award (Germany)
- FEBY (Sweden)
- Low Energy Class (Denmark)
- Minergie (Switzerland)
- Passivhaus (incl. PH Plus and PH Premium)

Europe - Best practice voluntary standards for existing buildings

- Better Home
- EnerPHit (incl. Plus and Premium)
- Energiesprong (Netherlands first, now several including UK)
- iSFP
- My Home Retrofit Planner (UK)
- Passeport Efficacité Énergétique (France)
- Whole House Plan (UK)
- Woningpas (Germany)

Simulation tools

- SAP tools (Elmhurst, FSAP, JPA, etc)
- EnergyPlus
- Design Builder
- PHPP and Design PH
- Sefaira
- EDL TAS
- IESVE
- IDA-IC
- Open Studio
- Thermo 7 (Switzerland)
- Simien 7.0 (Norway)
- eQuest
- Honeybee
- HULC (LIDER-CALENER Unified Tool)
- Be18 (Denmark)

Review of best practice building energy models and regulation | Scope

We have split the review of regulations, best practice voluntary standards and building energy models into three distinct categories, to show the interaction of component parts of policy, regulation and modelling. These are defined below:

E Ecosystems

The review of ecosystems includes regulation, policy and best practice voluntary standards. These often form the framework that encompasses the modelling methodologies. *UK examples include: Approved document Part L, Planning policy and Passivhaus.*

M Modelling methodologies

The review of modelling methodologies includes best practice modelling methodologies used in regulatory compliance and voluntary frameworks. *UK examples include: SAP, TM54 or PHPP.*

T Tools

The review of tools includes simulation tools used to implement regulations and voluntary standards. Best practice design tools that provide a mechanism for additional or bespoke energy calculations have also been reviewed. *UK examples include: IESVE, JPA or EnergyPlus.*

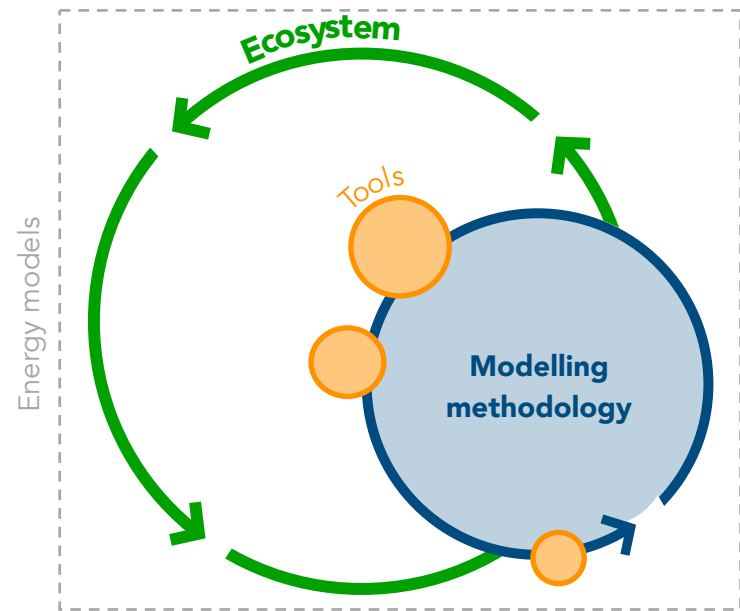

Relationship of ecosystems, modelling methodologies and tools

Europe and the world

We have also split the review by location, taking examples from Europe and the world. Over 40+ models used in regulations, standards, policy and best practice voluntary standards have been evaluated.

29 European countries are required to follow the EU Energy Performance of Buildings Directive (EPBD). This allows for an interesting comparison of the variety of interpretations and responses to the directive when striving to achieve Net Zero Carbon. Switzerland is outside the requirements of the EPBD, but has also been reviewed in this category for simplicity. 10 countries have been reviewed in detail.

The world focus has been on Australia, states of the USA and provinces and territories across Canada, for which we have reviewed the most relevant ecosystems and modelling methodologies and tools.



Regulations, best practice voluntary standards and building energy models from 10 European countries have been reviewed in depth



Regulations, best practice voluntary standards and building energy models from around the world have also been reviewed

This page focuses on the findings of the best practice ecosystems in Europe and across the world.

Various routes to compliance



The Norwegian building regulations require either a total energy use target to be met or a prescriptive path can be taken where the building fabric must be equal or better than limiting parameters (similar to a building fabric that is required for Passivhaus).

A number of methods offer several compliance pathways, often as a prescriptive path (i.e. set fabric and system requirements) and a modelled performance path.



Seattle and Boulder both have an in-use performance path as part of their regulations. In Seattle for the in-use target performance path, the Energy Use Intensity (EUI) target is 12% looser than the modelled performance path. There is mandatory disclosure within 3 years of occupancy. A financial penalty is applied if the target is not met, but 50% of the fine can be reinvested in building improvements. Metered energy data is supplied via automated reporting from utilities to the regulators using Portfolio Manager and adjusted for percentage of conditioned floor area and occupancy. British Columbia Step Code - Energuidance Compliance Path (Canada) has options for a relative compliance path and an absolute compliance path.

Building labelling and disclosure



Requirements for future reporting is useful to help diagnostics, benchmarking and reduce actual energy use. It can also help inform future regulations and tools. In-use energy consumption disclosure is required in regulations in Sweden and is a planning policy requirement in London. The voluntary DGNB Climate Positive Award (Germany) and Energiesprong require energy in-use data disclosure.



Most of the best practice global standards reviewed have in-use energy data disclosure including the Toronto Zero Emissions Buildings Framework and Vancouver Zero Emissions Building Plan (Canada), the City of Boulder Energy Conservation Code and ILFI Zero Energy Certification (USA).

Best in class fabric



Swiss and Norwegian regulation include very good limiting fabric parameters, broadly aligned with Passivhaus. Passivhaus is seen as the most robust standard in Europe for building fabric.



Tier 4 of the Toronto - Zero Emissions Buildings framework, and Step 5 of the British Columbia Step Code include very robust Thermal Demand Intensity (TEDI) targets.

A clear long term target definition of zero carbon



Alongside a definition of Net Zero Carbon, a clear long-term target aligned with carbon budgets and science-based targets gives industry clarity on direction. The simulation tool must then respond to this by identifying buildings that meet the regulation/standard, and that meet the zero carbon target. CaGBC Zero Carbon Building Standard is aligned with Zero Carbon. The British Columbia Step Code (Canada) and Toronto Zero Emissions Framework has clear steps towards zero carbon.

Scrutiny and collaboration



The Swiss building regulations require close collaboration and continuous engagement between design team and authorities. They focus on reducing demand from the early design stages with a fabric first approach. Fabric build-ups, wall thickness and thermal bridging details must be submitted/audited at pre-planning stage, and submission targets committed to.



In British Columbia (Canada) the simulation tool is relatively simple, however, a high level of precision of inputs is required. The model is updated post construction and the performance of systems is updated based on model numbers of the equipment that was installed.

Clear differentiation between in-design and in-use



The Canadian Green Building Council (CaGBC) has a Zero Carbon Building Design Standard that represents a one time certification for new buildings and major renovations and which focuses on the design of buildings. It has a separate Zero Carbon Building Performance Standard for buildings in operation which is an annual certification based on metered energy use. A new building is certified in design using the 'design standard' and then is encouraged to pursue annual Net Zero Carbon certification with the 'performance standard'. Such a system would help refine the performance gap.

Stepped targets



Various approaches apply stepped targets setting a trajectory over the coming years, helping the industry prepare. In the Toronto Zero Emissions Framework all new planning applications must meet Tier 1 of the targets, with financial incentives to meet Tier 2 before it becomes the minimum requirement at the next revision. In the British Columbia Step Code, cities and regions can choose which step to implement as mandatory with near Passivhaus to be mandated region-wide by 2030.

In the UK and worldwide, successful retrofit approaches often offer a long-term target, with a stepped approach which homeowners can adopt according to their budget and opportunities arising over time.

Energy modeller qualifications and quality assurance



Some regulations, standards and certification schemes require a higher level of qualifications and quality assurance than the UK. For example, under Seattle regulations energy modelers must have at least 2 years of experience modelling buildings of similar scale and complexity. For Energuide (the residential component of the British Columbia Step Code, Canada) there are strict energy modeler qualifications with robust auditing.

Best practice UK retrofit approaches typically include an additional level of training and quality assurance, compared to domestic energy assessor qualifications.

Refrigerant leakage



Refrigerant leakage could have a significant impact on the greenhouse gas emissions associated with a building, and in some cases could be higher than the carbon emissions related to operational energy. These are not emissions directly from fuel consumption, but are related to operational energy use. In the CaGBC Zero Carbon Building Design Standard, the estimated refrigerant leakage must be reported; in the CaGBC Zero Carbon Building Performance Standard the refrigerant leakage must be offset annually. In the Vancouver Zero Emissions Building Plan – Path B requires reporting of emissions from refrigerants.

Embodied Carbon



Living Building Challenge certification requires embodied carbon to be offset. The CaGBC Zero Carbon Standards require embodied carbon (Stage A, B and C emissions) to be reported and offset (Stage A in year 1, Stage B annually).

In the Vancouver Zero Emissions Buildings Plan (ZEBP) all projects must report the life-cycle equivalent carbon dioxide emissions as calculated by a whole-building life-cycle assessment (LCA)



Last year Denmark began a two-year test period where Life Cycle Assessment is included as a criteria, the experience from this testing period will be included in the new regulations to come in 2023.

From Summer 2021 an assessment of whole life carbon emissions will be made mandatory in France for new buildings above a certain size. This new regulation has been tested in the last 2 years by the certification HQE E+/C-. Life cycle assessments will be made using national listed tools and a national database: INIES.

Resilience



The Toronto Zero Emissions Buildings framework includes a Climate Change Resilience Checklist for new development.

Below are leading examples of ecosystems that are most relevant to achieving Net Zero Carbon. It is recommended that these ecosystems be researched further in the development of SAP/RdSAP 11.

Seattle Energy Code (Regulation)



- Various paths of compliance, a prescriptive approach, a modelled EUI path and a target performance path where the projects must achieve in-use energy targets.
- Living Building Challenge Pilot Program: Height and density bonuses for developments pursuing Living Building Challenge full certification or living building challenge petal certification and EUI reduction of 35% more than the Seattle performance path.
- Strict energy modeler qualifications.

City of Boulder Energy Conservation Code (COBECC) (Regulation)

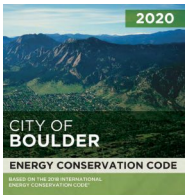

- Two distinct regulations, one for detached one and two-family dwelling and multiple single-family dwellings less than three stories in height with a much simpler tool and another for residential buildings greater than three stories in height above grade (commercial buildings also have to meet this requirement).
- Pathways for compliance:
 - ✓ A fixed target performance path with EUI targets. Projects required to submit an analysis comparing design modelling to actual energy use for a consecutive 12-month period within two years of project occupancy.
 - ✓ A measured performance outcome path, where projects may demonstrate compliance with this code by documenting that the building has achieved the EUI performance based on metered energy use after occupancy.

CaGBC Zero Carbon Building Standard (Voluntary standard)



- EUI, TEUI and a Net Zero Carbon balance
- Excel based workbook that must be completed
- Reporting of embodied carbon, peak consumption and refrigerant leakage
- Separate standard for in-design and in-use.

Energiesprong (Voluntary standard)



- A performance guaranteed approach
- Net zero energy in operation as an option
- Space heating targets.

Passivhaus - Implementation in regulations



Brussels regulation require new development to meet the Passivhaus standard for its Capital region.



Various cities in Germany require the Passivhaus standard as minimum requirement for new build homes, this includes Cologne, Nuremburg and the City of Freiburg.



Luxemburg requires all new residential new build to meet the Passivhaus standard.



Dún Laoghaire, Rathdown, Ireland states *that all new buildings will be required to meet the passive house standard or equivalent, where reasonably practicable.*



In over 10 regions or cities across Europe the Passivhaus standard is required for all new public buildings.



In Vancouver Passivhaus compliance is a route to compliance for new buildings.



In Washington Passivhaus compliance is a route to compliance for new buildings. The City of San Francisco has included projects that aim for Passivhaus or EnerPHit certification in their list of options for fast-track planning approval.

This page focuses on findings from the best practice modelling methodologies in Europe and beyond, for new and existing dwellings.

The same tool used for regulations and voluntary standards



In Denmark, Norway, Germany, Sweden and Switzerland the same simulation tool can be used for regulations and best practice voluntary standards. This reduces design fees associated with energy modelling and encourages design teams to work towards targets beyond regulations.

The Swiss voluntary standard Minergie is based on the Swiss Building Regulations method, and its requirements work in parallel with the Building Regulations e.g. 'Minergie Basic' requires a further 10% improvement of energy consumption and 10W/m² of PV per house or block of flats.

Several UK retrofit methods developed by industry use SAP as their basis, but with modifications differentiating them from the regulatory uses of SAP.

Evolution of metrics and targets



In France, RT 2012 introduced absolute targets, ending the use of a notional building. Moving away from primary energy towards an EUI metric has also been strongly recommended, in an independent review of the RT2012 (Académie des Technologies, 2014), to align with climate objectives, engage consumers and end dependency on gas. This advice has not been adopted in RT2020, perhaps to follow the EPBD (CGEDD-CGE, 2018).

Methods used for regulatory compliance and predictive modelling



In SAP/RdSAP, parameters such as occupancy profiles, set points and internal gains are set and cannot be modified. If a design team wants to undertake predictive (or 'performance') modelling they need to build a new model using a different simulation tool, which is time consuming. The simulation tools used in regulation in Germany, Finland and British Columbia (Canada) have this capability. Being able



to use the same simulation tool makes it relatively quick to carry out predictive design stage modelling, as most of the entries can be re-used from the compliance model.

Reporting and reducing peak energy consumption



In the Canadian Green Building Council (CaGBC) Zero Carbon Building Design Standard winter and summer peaks must be reported based on the energy model, and in-use peaks are reported in the 'Performance Standard'. The peak demand values (in kW) reflect peak-shaving impacts from demand management strategies including on-site power generation or energy storage. There is no target, just the requirement to disclose. In California's code Title 24, a time dependant value energy metric (TDV) is used, where a weighting is applied depending on when the energy is required.

Different methodologies based on scale of the development



Some regulations have different methodologies depending on the scale of the residential building. For example in Boulder (Colorado), and in British Columbia (Canada) residential developments that are 3 stories or less are treated differently to those that have more than 3 stories (which are treated the same as commercial buildings).

Clear reporting templates



The CaGBC Zero Carbon Standard has clear Excel-based reporting templates that provide a useful indication of performance.

Holistic design taking account of energy and overheating



If the Denmark Be18 tool flags that the home is at risk of overheating, then a fictional cooling load is automatically added as a penalty in order to encourage external shading and other passive measures.



In the British Columbia (Canada) HOT2000 tool, window size and operability affects cooling energy consumption that is reported by the model (even if the building has no active cooling systems). This information can be used to evaluate overheating risk.

The following common themes were identified from the modelling methodologies reviewed across Europe and the world. It is recommended that the organisation developing SAP 11 engages with counterparts in these countries to learn from them.



Total energy use metric

An Energy Use Intensity (EUI) target that includes regulated and unregulated energy consumption (kWh/m²·yr). It allows actual in-use performance to be measured and compared to the modelled target.

Regulatory models:

- Toronto Zero Emissions Buildings Framework (Canada)
- Vancouver Zero Emissions Building Plan (Canada)
- Washington DC – Appendix Z (USA)
- Boulder Energy Conservation Code (USA)
- Seattle Energy Code (USA)
- British Columbia Step Code (Canada)
- Norway TEK 17 (net of PV energy*)

Voluntary models:

- CaGBC Zero Carbon Building Design Standard (Canada)
- Zero Code California (USA)
- Better Home
- iSFP
- Minergie (net of PV energy*) (Switzerland)

* Both the Norway regulation and Minergie use an energy use metric that includes the benefit of electricity generated by PV.



Space heating metric

A metric that assesses the efficiency of the building fabric and the ventilation system. A tool with this quality calculates space heating and space cooling demand accurately, whilst acting as a design tool. This improves resilience and reduces energy use and bills.

Regulatory models:

- National code of Finland
- BENG (Netherlands)
- BR18 (Denmark)
- Washington DC Appendix Z (USA)
- Vancouver Zero Emissions Building Plan (Canada)
- British Columbia Step Code (Canada)
- Toronto Zero Emissions Framework (Canada)
- NatHERS (Australia)

Voluntary models:

- Passivhaus
- Low Energy Class (Denmark)
- FEBY (Sweden)
- CaGBC Zero Carbon Building Design Standard (Canada)
- EnerPHit
- My Home Retrofit Planner
- Energiesprong



On-site renewable energy metric

Reporting on-site renewables energy generation encourages and tracks the building's contribution to national generation of zero carbon energy.

Regulatory models:

- DEAP (Ireland)
- GEG (Germany)
- RT2020 – as part of “net positive” target (France)
- BENG (Netherlands)
- Toronto Zero Emissions Framework (Canada)
- Title 24 (California)
- Washington DC Appendix Z (USA)

Voluntary models:

- Minergie A (Switzerland)
- Zero Code California (USA)
- Passivhaus Premium
- Energiesprong
- ILFI- Net Zero Energy / Living Building Challenge
- DGNB Climate Positive Award (Germany)



Absolute targets

Methods that do not compare against a notional building.

Regulatory models:

- BBR (Sweden)
- TEK17 (Norway)
- RT2020 (France)
- BR18 (Denmark)
- BENG (The Netherlands)
- National Code of Finland
- Vancouver Zero Emissions Building Plan (Canada)
- City of Boulder Energy Conservation Code (USA)
- Seattle Energy Code (USA)
- Toronto Zero Emissions Buildings Framework
- NatHERS (Australia)

Voluntary models:

- Low Energy Class (Denmark)
- FEBY (Sweden)
- Passivhaus
- EnerPHit
- My Home Retrofit Planner
- Passeport Efficacité Energétique (France)
- Woningpas (Belgium)
- iSFP (Germany)

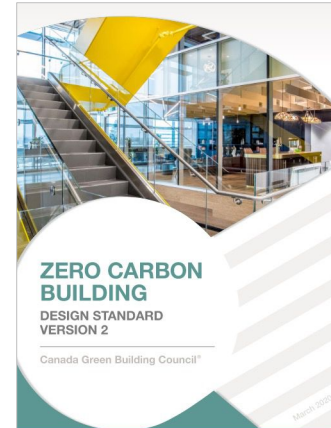

CaGBC Zero Carbon Building Design Standard (Canada)



TEK 17 (Norway)



Steady state modelling method

Modelling methodologies that are robust, encourage fabric first standards and use steady state methods.

Regulatory models:

- BR18 (Denmark)
- SIA380/1 (Switzerland)
- GEG 2020 (Germany)
- BENG (Netherlands)
- National Code of Finland
- TEK 17 (Norway)

Voluntary models:

- Low Energy Class (Denmark)
- Passivhaus
- Minergie (Switzerland)
- EnerPHit
- Methods based on adaptations to SAP/RdSAP e.g. My Home Retrofit Planner, Whole House Plan

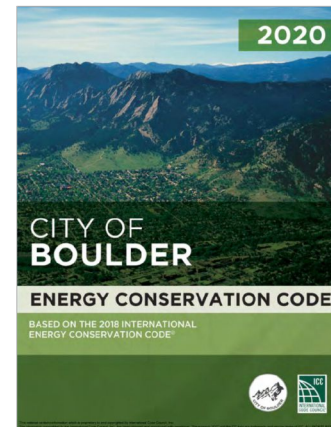

City of Boulder Energy Conservation Code (USA)

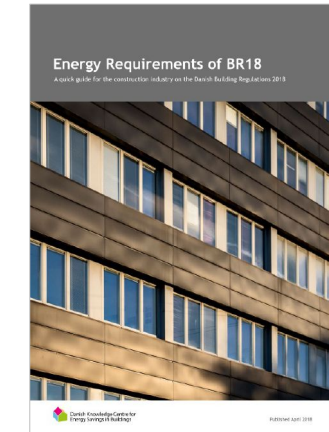

BR18 (Denmark)

Lessons are available from industry on best practice retrofit

A number of methods have been developed to assess existing homes and possible improvements. In the UK, the most interesting and advanced (albeit not widespread) are those developed by Urbed and Carbon Coop, by Parity Projects, and for the Green Deal assessment:

- They have been developed as adaptations of SAP or RdSAP.
- They have been informed by post-retrofit feedback; and more data on correlations between calculated and actual energy use is expected in the future.
- They are part of a wider assessment to inform a one-off or stepped retrofit plan.

Lessons must be learnt from these methods.

SAP can be used as energy tool for retrofit

The most important lesson is that **SAP has the potential to inform retrofit strategies and produce calculations of energy use that are reasonably close to actual performance, particularly for space heating.** Typically this is achieved as follows:

- Small changes to the SAP calculation algorithm itself
- A target, often beyond regulatory compliance
- Use of the home's actual regional location and weather data
- Key inputs to represent how that home is used, based on a site visit. Most important are the number of occupants, heating set points and patterns.
- Measured or estimated fabric performance instead of default SAP/RdSAP inputs¹

A similar approach is recommended for SAP 11, although some features could be outside of regulatory purposes (e.g. occupancy patterns).

Wider retrofit approach, beyond SAP

Retrofit is complex, and SAP cannot do it all. Best practice methods also rely on:

- A competent individual leading the retrofit strategy
- Holistic considerations alongside the energy calculation : mould, ventilation, comfort, etc. This is done separately from SAP.

¹ The development of SAP11 should consider where this adds value, and whether to change or expand the options for default values.

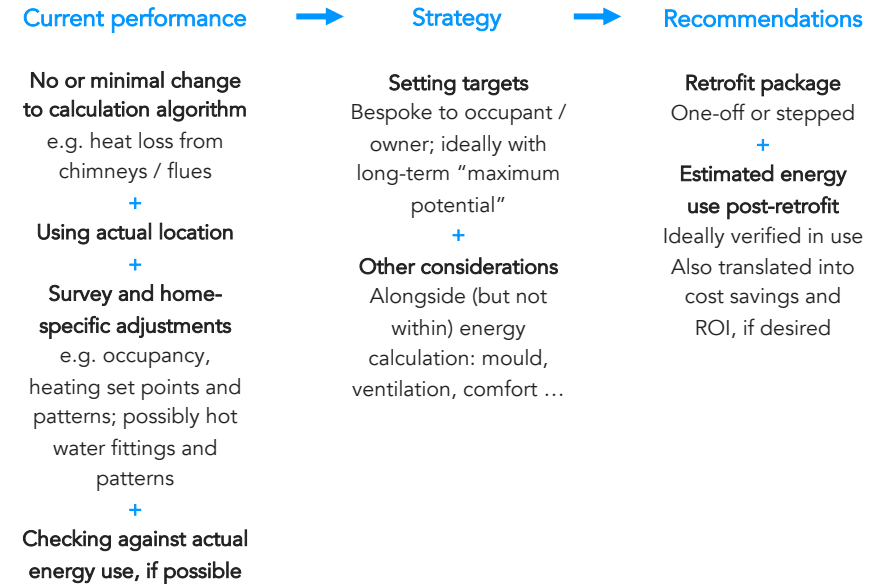

Typical approach of UK retrofit methods based on adaptations to SAP/RdSAP

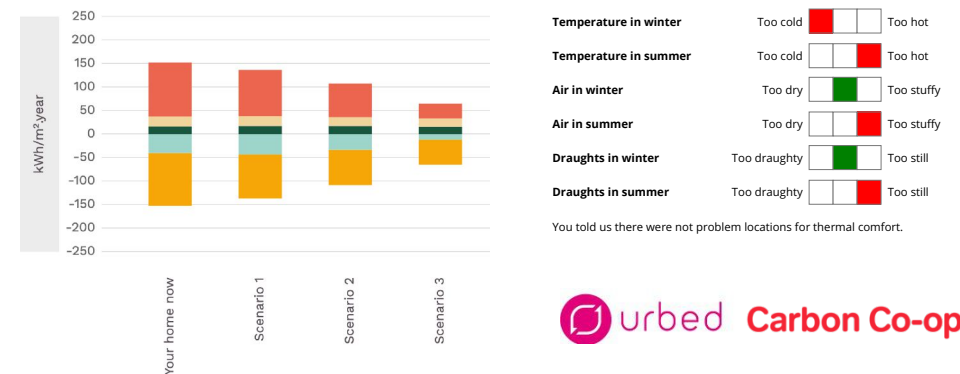

My Home Retrofit Planner helps homeowners by including a "best possible" end point (scenario 3 in the above) alongside other possible scenarios. It considers other issues alongside energy use, including comfort and air quality, and is informed by a survey of occupants - shown right.



Below are leading examples of modelling methodologies that are most relevant to achieving Net Zero Carbon. It is recommended that these modelling methodologies be researched further in the development of SAP 11.

Germany GEG (Hottgenroth / Solar computer)



- Monthly steady state model.
- Industry wants to move away from primary energy.
- The methods behind the simulation model are based on the DIN 18599 with standard profiles and set points used for the regulation assessment. Profiles and set points can be easily amended for design calculations used for the DGNB climate positive award.

Passivhaus (PHPP)



- A steady state tool that is useful to use as a design tool to reduce energy demand and is good at predicting energy use.
- Transparency (has the ability to unprotect and view the cells).
- Calculation methodology of heating, hot water and ventilation systems, pipe heat losses, thermal bridging, and unregulated energy consumption.

Norway TEK 17 (Simien)



- Energy consumption target (net PV).
- Minimum renewable target.
- Options for steady state or dynamic simulation (Simien).
- The best practice voluntary standard in Norway is a Norwegian variant of the Passivhaus Standard (the energy level sits between the TEK 17 and the standard Passivhaus). Simien can be used to show compliance with the Norwegian Passivhaus standard. They are looking to implement the Norwegian Passivhaus standard as mandatory in the future.

Denmark BR 18 / Low Energy Class (Be 18)



- Absolute targets.
- The primary energy target depends on the size of the home.
- A heat loss target in W/m^2 .
- There is a fictional cooling load penalty. If the tool flags that the home is at risk of overheating, then a fictional cooling loads is automatically added as a penalty in order to encourage external shading and other passive measures.
- Low Energy Class is the Danish voluntary building standard, the same simulation tool is used as for compliance analysis, and the same metrics are used, but with tighter targets.
- Denmark is looking to implement a national database of calculated annual energy use and energy label rating with automatic data disclosure using data from energy companies.
- Life Cycle Assessment (LCA) is not currently included as a requirement in the Building Regulation. A test period of two years has started last year, where LCA is included as a criteria and the idea is that the experience from this testing period will be included in the new regulations to come in 2023.

Finland Code of Finland



- Steady state monthly method model with normalised set points for occupancy, DHW etc, to be used for compliance modelling. This can be edited to be specific for the project for performance modelling.
- Optional dynamic modelling software available used for more complex buildings.
- Heat loss metric – absolute target - unit is W/m².
- PV generation only counts as part of the calculation if it is used by the building. This incentivises systems that use the renewable energy. Any energy that is generated and sold to the grid is not included in the EPC rating (primary energy).

Switzerland SIA 380/1 and Minergie (Thermo7)



- Steady state modelling.
- A consistent approach of tool and metrics for compliance and Minergie (best practice standard).
- Robust approach for thermal bridges at planning. SIA 380/1 requires a detailed description and a section of the proposed build-ups for all fabric elements, i.e. not just a proposed U-value, but also a technical description of the way in which works will be undertaken on site. Encourages good design from early design stages with audits throughout stages.
- Minergie P is aligned with zero carbon.

British Columbia Step Code - Energuide Compliance Path (HOT2000 tool)

- Steady state tool for residential building with less than 3 storeys or under 600m²
- Metric: Thermal Energy Demand Intensity (TEDI), Total Energy Use (EUI) and Mechanical Energy Use Intensity (MEUI).
- Targets: Stepped targets.
- Thermal bridging is calculated on construction method inputs rather than defined by psi- values.
- Can be used for 'non regulatory uses' where occupancy, set points, DHW use etc. can be changed.
- Strict energy modeler qualifications with robust auditing.

Netherlands BENG (Introduced 2021)



- Steady state modelling.
- Metrics: Heating and cooling demand, energy and renewables.
- For homes 50% energy consumption generated through renewables (for flats 40%).
- Overheating risk modelling (TOJuli) required as part of regulations in addition to BENG.

Summary | Energy Models

Name	Country	Metrics	Encourage fabric first standards	Ability to enable Net Zero	Can be used as a tool to design for energy use reduction	Steady state (SS) or Dynamic (DSM)	Demand management / peak	Simplicity of method
Europe - Regulation								
SAP	UK	CO ₂ , Cost + SAP 2012: FEES + SAP10.1: primary energy	** SAP 2012 * SAP 10.1	*	*	SS	-	***
BBR	Sweden	Primary regulated energy in kWh/m ² with Fgeo factor (excl.) lighting, limiting average u-values	**	**	**	SS+DSM	-	**
TEK17	Norway	Net energy consumption in kWh/m ² (includes PV)	***	**	***	SS+DSM	-	**
BR18	Denmark	Heat loss metric, primary regulated energy in kWh/m ² (excl. lighting)	***	**	***	SS	-	***
DEAP	Ireland	CO ₂ , primary regulated energy, energy cost, renewables	*	*	**	SS	-	***
BENG	Netherlands	Space heating in kWh/m ² , primary energy in kWh/m ² , and renewable target	**	***	***	SS	-	***
National code	Finland	Heat loss metric in W/m ² , primary energy with E-luku factor	***	**	**	SS+DSM	-	**
SIA 380/1 (2016)	Switzerland	Energy demand ¹ in kWh/m ²	***	**	**	SS	-	***
GEG 2020	Germany	Energy demand ¹ and primary regulated energy in kWh/m ²	**	**	***	SS	-	***
Europe - Voluntary standards								
FEBY (Forum för Energieeffektivt Byggande)	Sweden	Heat Loss metric, primary regulated energy in kWh/m ² with Fgeo factor (excl. lighting)	***	**	**	DSM	-	**
Low Energy Class (replacing Building Class 2020)	Denmark	Primary energy in kWh/m ² , excludes lighting, renewables	***	**	***	SS	-	***
Minergie	Switzerland	Net energy consumption in kWh/m ² (includes PV), renewables ⁽³⁾	***	** ⁽²⁾	***	SS	-	***
Passivhaus	Germany	Space heating, primary energy	***	** ⁽²⁾	***	SS	-	*

⁽¹⁾ Energy demand is to be understood as heating and hot water demand + regulated electricity use from ventilation and lighting

⁽²⁾ Minergie - A and Passivhaus Premium are aligned with Net Zero; the 'standard' Minergie and Passivhaus are less so, as dwellings may be heated by fossil fuels

⁽³⁾ Renewable energy metric for Minergie - A only

Key : *** Very good, ** Good, * Bad - Not included

Summary | Energy Models

Name	Country	Metrics	Encourage fabric first standards	Ability to enable Net Zero	Can be used as a tool to design for energy use reduction	Steady state (SS) or Dynamic (DSM)	Demand management / peak	Simplicity of method
World – Regulatory and voluntary standards								
City of Boulder Energy Conservation Code - Performance Path	USA	EUI	*	**	***	No modelling based on in use	-	**
Seattle - Performance Path	USA	EUI	*	**	***	DSM	-	*
Washington – Appendix Z	USA	EUI, TEDI, Renewables	***	***	***	DSM	-	*
California (Title 24)	USA	TDV Energy, Renewables	**	**	**	DSM	-	*
Zero Code - California	USA	EUI, TDV energy, zero carbon balance	**	***	***	DSM	-	*
Vancouver Zero Emissions Building Plan	Canada	TEDI, EUI, CO ₂	***	***	***	DSM	-	*
CaGBC Zero Carbon Building Standard	Canada	TEDI, EUI, carbon balance Reporting of peak consumption, embodied carbon and refig. leakage	**	***	***	DSM	**	*
Toronto Zero Emission Building Framework	Canada	TEDI, EUI, CO ₂	***	***	***	DSM	-	*
British Columbia Step Code-Energuide for homes	Canada	TEDI, EUI/MEUI	***	***	***	SS	-	*** (but precise)
Methods specific to existing dwellings and retrofit								
Energiesprong UK	UK adapted from the Netherlands	Space heating, energy (lighting, cooking and plug loads). Net zero energy performance	***	***	n/a	n/a	-	n/a
EnerPHit	Germany	Space heating, primary energy	***	***	***	SS	-	*
My Home Energy Planner (Urbed & Carbon Coop)	UK	Space heating; possibly EUI in the future	***	**	**	SS	-	**
Whole House Plan (Parity)	UK	Depends on client priorities	Depends on client priorities	Depends on metrics used	**	SS	-	**

Key : *** Very good, ** Good, * Bad - Not included

Learning from different energy tools



A review of energy modelling tools from around the world was carried out, and the key findings are outlined below.

What makes a useful design tool

A useful design tool should be able to represent accurately the design of a dwelling and its systems, have a user-friendly interface, be flexible to include emerging technologies and stay up to date with all required parameters (e.g. efficiencies, factors, etc.). Such a tool should also allow for any necessary outputs that would be useful not just for regulatory purposes but also for designers.

Dynamic or steady-state?

A steady-state tool can offer simplicity and speed in particular for small and standardised dwellings, with fairly accurate results for space heating. A dynamic simulation can offer flexibility in the design and greater accuracy in particular when modelling complicated spaces, complex heating and cooling systems, controls for ventilation and lighting as well as demand management measures (e.g. whether the building is able to reduce peak demand and shift it to occur at times when clean energy is being generated). However, it is more sensitive to human error; it may also be more sensitive to assumptions rather than a 'robust average'.

Complexity vs simplicity

A balance should be struck between complexity and simplicity. A simple tool will be easier to use among a larger group of users and errors will be minimised. However, a slightly more complex tool could offer designers greater flexibility to incorporate complex designs. Both factors are important and therefore a middle ground should be found.

The majority of European tools rely on steady-state tools. Some regulations request additional dynamic modelling for more complex designs, or offer the designer the option to choose the suitable tool and present the results.

Transparency

The Passivhaus Planning Package (PHPP) is an excel based tool that can be 'unlocked' to show the calculation processes which helps the user understand if the assumptions made are relevant for the particular project. Energy Plus is another example of a simulation tool that is transparent, the methodology is clear and can be interrogated.



The above images shows a selection of the tools that were investigated

Tool	Complexity	Ability to enable Net Zero Carbon	Software cost
SAP 10	Low	Low	Free or Low
EnergyPlus	High	Medium	Free
Design Builder	High	Medium	Low/Medium
Sefaira	Medium	Low	Medium
EDSL TAS	High	Medium	High
IES	High	Medium	High
Open Studio	High	Medium	Free
Thermo 7	Low	Medium	Low
Simien 7.0	Low-Medium	High	Low
eQuest	Low	Medium	Free
Honeybee	High	Medium	Free
PHPP	Medium	High	Low
HULC (LIDER-CALENER Unified Tool)	Medium	Medium	-
Be18	Medium	Medium	Low
IDA-ICE	Medium	Medium	-

Table comparing some of the tools that were reviewed

Track record of in-use performance

Our review included a search for evidence and data on in-use performance of buildings that had used the energy models and standards reviewed. Although many of the experts interviewed expressed opinions on whether a methodology predicted energy use well or not, it is difficult to find robust academic papers, data or case studies. This reflects an endemic lack of building performance evaluation and data sharing. Where there is data, it often shows that past regulatory approaches have not fully delivered. In addition, a few of the more promising regulations and standards are relatively new, hence the buildings have not been completed or monitored yet. Information could only be found for Passivhaus, Living Building Challenge and BASIX.

1. Passivhaus

Various studies have been undertaken that show the in-use performance of Passivhaus developments are similar to those predicted by the PHPP model. A study looked at over 2,000 Passivhaus homes and on average they required a space heating demand of 14.6 kWh/m²/yr, very close to the Passivhaus requirement of less than 15 kWh/m²/yr (Johnston et al, 2020).

2. Living Building Challenge

Despite being an individual building, this project illustrates the usefulness of a good model. It is a single-family home certified under the Living Building Challenge. The fabric was designed to standards that exceed the 2015 Washington State Energy code, and a south-facing PV system generates electricity. Interesting, the *profile* of actual energy use is very similar to the modeled one – see illustration.

3. Australia - Residential BASIX

BASIX is a state environmental planning policy used to assess and regulate the performance of proposed residential dwellings in New South Wales, using the Nationwide House Energy Rating Scheme (NatHERS) rating tool. Results show that the measured BASIX-compliant dwellings performed well and close to BASIX estimations, validating the effectiveness of BASIX tool in promoting low carbon dwellings: the average measured greenhouse gas emissions are 16% lower than estimated by BASIX; 61% achieved a higher post-occupancy BASIX score than estimated, 24% achieved a lower score and 15% had no significant changes..

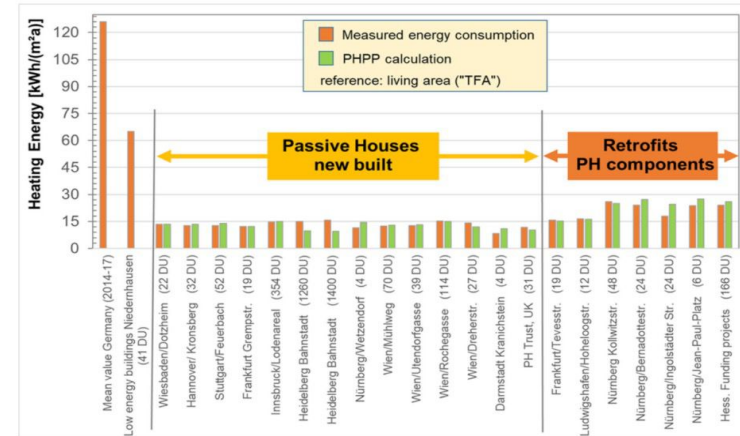

In this study, a comparison was also made between the measured space heating energy consumption and the predicted space heating energy demand. Over 2,000 newly built Passivhaus dwellings and 130 retrofitted dwellings were considered (Source: Johnston et al, 2020)

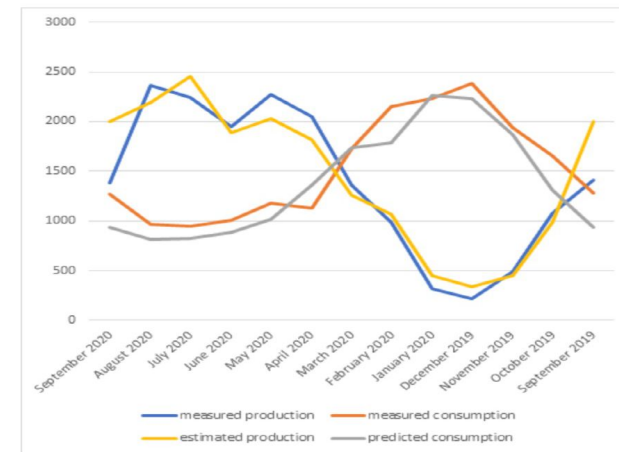

The graph above shows the alignment between the predictive energy model and the in-use data. (Source: Elementa Consulting)

In-depth reviews

An in-depth review was carried out for nine modelling methodologies, outlined in the table below. Methodologies for new build and existing buildings were included.

1 PHPP	Voluntary	New build and existing
2 CIBSE TM54	Design tool	New build and existing
3 Minergie	Voluntary	New build
4 CaGBC – Design Standard	Voluntary	New build
5 Energiguide for homes (British Columbia Step Code)	Regulation and Voluntary	New build
6 Norwegian Regulation	Regulation	New build and existing
7 My Home Retrofit Planner	Voluntary	Existing dwellings
8 Whole House Plan	Voluntary	Existing dwellings
9 Green Deal Assessment	Voluntary	Existing dwellings

Example of page 1 of the in-depth review

The in-depth reviews of these modelling methods are provided in section 7 of this report.

Further information on best practice ecosystems around the models is also provided in section 7 (e.g. Toronto Zero Emissions Buildings framework, Vancouver Zero Emissions Building Plan, Washington DC – Appendix Z, Seattle Energy Code, Energiesprong).

Example of further information provided for various standards

4.0

25 key recommendations for SAP/RdSAP 11



This section summarises our 25 key recommendations. Adopting them would help set the development of SAP/RdSAP 11 on the right track towards it becoming a central tool to deliver the Government key policies, and particularly the overarching Net Zero Carbon objective.

25 key recommendations for SAP/RdSAP 11

The review of policy objectives and of the changing landscape around new and existing housing has led to the clarification of priority objectives which SAP/RdSAP is crucial for: **Net Zero Carbon**, **energy efficiency** (including demand reduction and flexibility), and **heat decarbonisation**.

The priority functions of SAP need to derive from these objectives. The literature review, our engagement with experts and our review of other energy modelling methodologies around the world have all provided interesting clues as to how these objectives and functions could be better supported in SAP and RdSAP 11.

Altogether, this has led to the 25 key recommendations listed here.

These recommendations focus primarily on what is within SAP and RdSAP's remit. If they are all addressed by SAP and RdSAP 11, these methodologies will be much better and much more able to deliver their new overall objectives: accompany the design and construction of Net Zero Carbon ready new homes and the low carbon whole house retrofit of existing homes.

Some of these recommendations go beyond the strict boundaries of SAP/RdSAP. They have been made to ensure that there is consistency between the methodologies and their 'eco-system', otherwise changes to methodologies will not be as effective as they could be. These include the recommended move away from a notional building approach, and the change of the EPC rating (produced by SAP / RdSAP) to align with the recommended main metric for SAP / RdSAP i.e. moving from a cost-based rating to a energy use-based rating.

Alignment between SAP/RdSAP and its strategic objectives

1	SAP can and must become a tool for Net Zero Carbon ready new buildings
2	SAP/RdSAP can and must become a better tool for whole house retrofit
3	SAP/RdSAP can and must become better at evaluating energy use
4	Homes need to become smart ready and SAP/RdSAP needs to help with this
5	SAP can and must play a bigger role in reducing the performance gap

Improvements to the methodology

6	Carbon factors: replace the short-term with long-term factors (e.g. 25-year average)
7	SAP should remain a steady-state monthly tool, but with a new module for flexibility
8	SAP should 'tell the truth' and enable bespoke non-regulatory uses
9	A significant improvement of Appendix Q and the PCDB process is required
10	Overheating: towards a simplified 'flagging system'?
11	SAP/RdSAP outputs need to be compatible with disclosure and data analysis goals

Improvements to SAP/RdSAP and its ecosystem for Net Zero

12	No more notional building: the introduction of absolute energy use targets
13	New metrics for Net Zero Carbon (and not primary energy)
14	Better governance: a modular architecture and an evidence-based culture
15	New EPC ratings from SAP/RdSAP to support Net Zero and fuel poverty objectives
16	SAP should be fully integrated in the digital age

A better evaluation of energy use

17	Location should be taken into account and not normalised as it is now
18	Domestic hot water should be modelled more accurately
19	SAP/RdSAP should better model the energy performance of ventilation systems
20	Thermal bridges: good practice should be rewarded (and bad practice penalised)
21	SAP needs to better reflect all energy uses, including cooking and white goods
22	Occupancy: the standardised assumptions should be re-validated

Support to decarbonisation of heat and electricity

23	SAP/RdSAP needs to model all heat pump systems accurately to reward efficiency
24	Heat networks: SAP/RdSAP should evaluate distribution losses more accurately
25	Solar Photovoltaics require better modelling and a prominent SAP/RdSAP output

1 SAP can and must become a tool for Net Zero Carbon ready new buildings

This must be SAP 11's primary function

Informing and accompanying the delivery of Net Zero Carbon ready homes must be the main overall objective of SAP 11 and its primary function, not just one of many. This means that what is important for the design and construction of Net Zero Carbon ready homes should become fundamental in the development of SAP 11 and should define its key outputs.

Net Zero Carbon ready new homes – the key themes

The work done by Government, the Climate Change Committee, industry expert networks and industry professionals in recent years has helped to identify the key requirements for Net Zero Operational Carbon new homes:

- 1. Ultra-low space heating demand.** Reducing space heating demand to a level in line with the Climate Change Committee recommendations for new housing (i.e. 15-20 kWh/m²/yr) is both a necessity and an opportunity: it will also ensure that heating costs are minimised with a good fabric and ventilation system.
- 2. Low total energy use.** The level of total energy use should be as low as possible: an efficient heating and hot water system and low energy lighting, fittings and appliances need to complement the fabric and ventilation. Energy Use Intensity (EUI, kWh/m²/yr) must be a key SAP output.
- 3. No fossil fuels and low carbon heat.** A Net Zero Carbon ready home should use a low carbon heating system (e.g. heat pump), and no fossil fuels on-site.
- 4. High renewable energy generation.** Alongside the reduction in energy use, renewable energy generation is critical for Net Zero and on-site solar PVs have an important to play. Solar PV generation should become a SAP output.
- 5. Energy flexibility.** All experts agree that new homes need to be better integrated in the wider energy system. They should have a reduced peak demand, and an increased ability to use energy when clean energy is available.
- 6. Reduced performance gap.** Net Zero Carbon should not be just a 'design objective', it must be delivered after construction and in operation.

Embodied and whole life carbon

Embodied/whole life carbon is crucial for Net Zero but is not covered by SAP. Its integration could potentially be considered in the future.

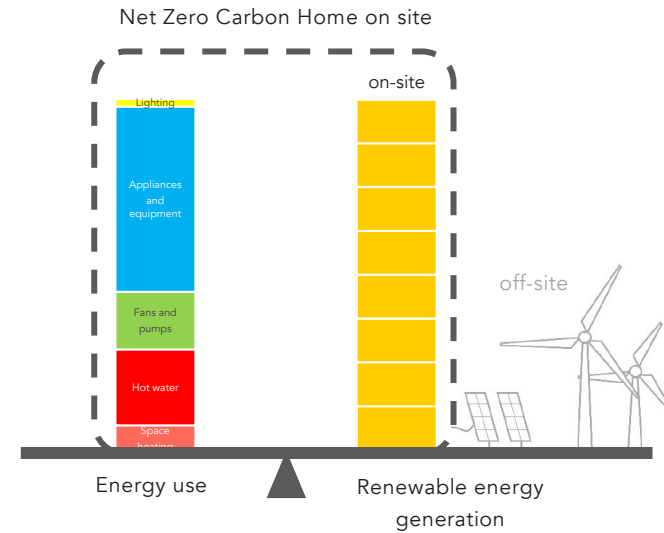

To achieve Net Zero Operational Carbon, the energy use of a new house should be matched by renewable energy generation. The example shown is for an energy efficient house that is heated by a heat pump. Each orange block represents the energy produced by a single solar photovoltaic panel. In this case, off-site generation is not required to achieve Net Zero.

1	2	3	4	5	6
Ultra-low space heating demand	Low total energy use (EUI)	No fossil fuel and low carbon heat	High renewable energy generation	Energy flexibility	Reduced performance gap
Potential SAP output:	Potential SAP output:	Potential SAP output:	Potential SAP output:	Potential SAP output:	
kWh/m ² /yr space heating demand and/or HTC	kWh/m ² /yr Energy Use Intensity (EUI)	kgCO ₂ /m ² /yr heating system only or total	kWh/m ² /yr building footprint solar energy generation	SRI or kWh/m ² /energy storage or proportion of demand that can be shifted	

Six key requirements for a Net Zero Carbon ready new home and potential associated SAP outputs

All recommendations for SAP in this report would benefit both new and existing buildings. In addition, there are specific ways in which SAP and RdSAP can become much better tools for existing dwellings and retrofit. A key lever is that **SAP should be used more often on existing buildings**, instead of elemental approaches allowed in Building Regulations. In addition, **RdSAP should gradually be phased out**, taking the opportunities from digitisation to base decisions on more accurate and comprehensive data: see Appendix I on changes to the system around SAP/RdSAP to encourage low-carbon retrofit and avoid detrimental consequences.

Outline a Net Zero compliant end-goal

SAP/RdSAP used on existing buildings should indicate the potential energy and carbon performance with a deep whole-house retrofit approach, regardless of the regulatory target at that time - see recommendation 12 on target setting.

Better identify and assess whole-house energy measures

Several recommendations in this report would improve the evaluation of energy use for all homes. In addition, specific measures would improve the evaluation of current and potential energy performance of existing homes, promote whole-house rather than elemental approaches, and allow scenarios to better deal with uncertainties and represent the conditions specific to a home – see adjacent box.

Better support a holistic retrofit framework, including PAS 2035

A holistic approach must be promoted to deliver multiple benefits and avoid unintended consequences. We have reviewed whether SAP could and should become a holistic tool that would consider issues such as moisture, ventilation and overheating. Options could range from simple “flags” to a fully holistic tool. We have concluded that for SAP to become a **holistic tool or even flagging system would require significant changes, adding complexity, and carrying risks as it would necessarily be limited**. Furthermore, government has already invested in PAS 2035 as a holistic retrofit approach, and this should be built upon.

On balance, it is therefore recommended that, as SAP becomes the tool of choice for its core function, i.e. evaluating energy performance, it will also become more commonly and confidently adopted as part of PAS 2035 and similar approaches, which consider holistic performance and point to specialised tools where appropriate e.g. moisture risk. Regulations must also play a role – see Appendix I.

For regulatory purposes:

- ✓ Use SAP more often, not elemental approaches
- ✓ Phase out RdSAP
- ✓ Use actual location
- ✓ Allow measured airtightness as input in RdSAP, and require it in more cases. As technology develops, ideally all retrofit works should have pre- and post-airtightness tests.
- ✓ Modify the balance in RdSAP from look-up tables towards more detailed surveys and measurements. Review RdSAP U-value figures and options (e.g. account for state of repair?). Require window dimensions as inputs, and allow as many window types as actually in the home.
- ✓ Use actual hot water fittings, lighting and appliances (even if unregulated).
- ✓ Review how to encourage measures that work well together in-use or in installation e.g. roof insulation and PVs.

Outside of regulatory purposes, to develop a home-specific retrofit plan:

- ✓ Give the ability to input specific occupancy density and patterns
- ✓ Give the ability to input heating setpoints and patterns
- ✓ Give the ability to input patterns of hot water usage (e.g. showers / baths) and appliances
- ✓ Give the ability to vary inputs where they are uncertain (e.g. U-values)

Summary of key recommended changes to how SAP/RdSAP is currently used in retrofit works. These have been informed by existing UK retrofit methods

Building Regulations: Part L, Part F, Part C, overheating, and associated guidance

More joined up, with clearer links between each Part and more requirements for joint consideration e.g. airtightness and ventilation; insulation, cold bridges, condensation risk and ventilation

SAP

Focus on evaluating energy use, and promoting whole-house energy improvements. Potentially flagging related issues e.g. ventilation; however, without significant changes this would be necessarily limited and thus carry risks; it is not currently recommended

PAS 2035

Already refers to SAP, and requires a holistic approach including state of repair, thermal comfort, ventilation, and moisture risk, and which points to specific assessments where required e.g. CIBSE TM59 for overheating, BS 5250 for moisture risk.

SAP should focus on evaluating energy use, while interacting with a stronger Building Regulations framework and PAS 2035 to support a holistic and whole house approach

A clear new priority for SAP/RdSAP, for many reasons

The review of priorities has made it clear that SAP/RdSAP must become better at evaluating energy use, so that it can better deliver energy and carbon objectives, be a more useful tool in the design, construction and retrofit of dwellings (and therefore encourage better design), facilitate engagement with residents on the performance of their home and enable a feedback loop between actual energy use data and energy use calculated by SAP/RdSAP.

It is possible. The review of best practice worldwide has indicated that even within methods which include some degree of normalisation, some show a good degree of correlation between predicted and actual energy use. The more bespoke tools where occupancy and other factors can be adjusted can achieve even better results so it is important that normalisation does not overly prevent higher accuracy, as it does at the moment in SAP/RdSAP.

This can be achieved by reducing the degree of normalisation (e.g. location should not be normalised). SAP/RdSAP should also enable a non-regulatory use with bespoke inputs (e.g. occupancy could be normalised for regulatory purposes but a flexible input for non-regulatory purposes).

More accuracy on space heating

One of the key issues to resolve in terms of evaluating energy use relates to space heating which tends to be under-estimated in SAP, especially for new dwellings and within them, flats. Methods such as PHPP and Minergie show this can be evaluated with a higher degree of accuracy, even under normalised occupancy. Whilst variations between dwellings will always exist due to people's preferences and behaviour, the evaluation of space heating demand can and should be much closer to the average performance than it is now.

Capturing appliances and cooking energy demand

Whether energy uses which are currently 'unregulated' (e.g. cooking and appliances) become part of the regulatory target or not, they need to be evaluated in SAP/RdSAP: they are becoming a much larger proportion of energy use in low energy homes, smart technologies and on-site renewable energy generation 'interact' with these energy uses (making a demarcation very artificial) and 'real' Net Zero operational carbon can only be achieved including all energy uses.

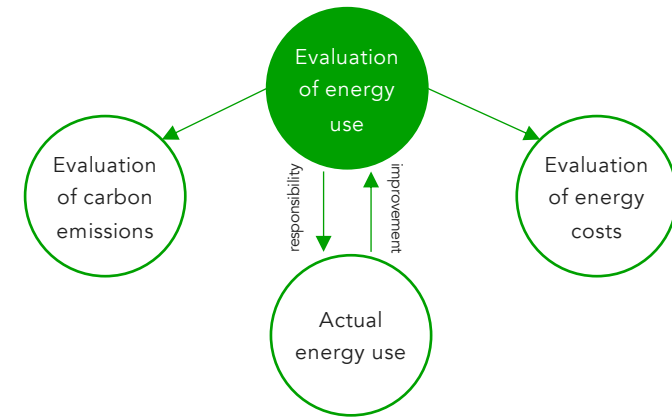

SAP should have the ambition of becoming a much better tool at estimating energy use. Not only would it make the prediction of carbon emissions and energy costs more accurate, it would also have multiple benefits through the creation of a feedback loop between estimated performance and actual performance in-use.

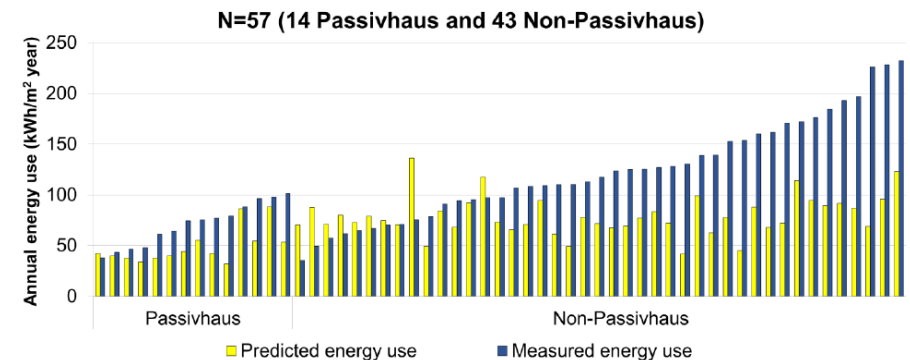

One of the reasons for the success of the PHPP modelling methodology used in Passivhaus is the ability to better predict average energy use: measured energy is on average lower, but it is also closer to predictions than in other methods (Source: BPN State of the Nation report, 2020)

4 Homes need to become smart ready and SAP/RdSAP needs to help with this

Net Zero Carbon requires energy storage and demand management

As electricity becomes the main fuel for homes, shifting energy use to coincide with renewable generation, at both the local and system scale, will be crucial to minimise reliance on fossil fuels as cost effectively as possible. In order for SAP/RdSAP 11 to be fit for Net Zero, it must be able to reflect buildings with systems that provide good flexibility and enable energy use to match clean energy generation.

In addition, SAP/RdSAP 11 should make the most of opportunities for performance analysis and consumer engagement created by smart meters.

SAP/RdSAP is a key 'route to market' for storage and smart controls

SAP/RdSAP has a critical role in enabling smart technologies and it should be one of the priority areas for SAP/RdSAP 11. One current limitation is that key technologies cannot be modelled properly, partially due to the limitations of the current Appendix Q and PCDB process. Enabling SAP/RdSAP to accurately model and account for technologies such as energy storage and smart controls will help to incentivise their adoption and make SAP a more effective design tool towards smart ready homes, rather than just a compliance test. This is all the more important that many technologies cannot easily be retrofitted, for example thermal mass, fabric efficiency or hot water storage.

Recommendations

SAP/RdSAP 11 should be able to model the useful demand management effects of: **building fabric** (e.g. thermal storage and the ability of well-insulated and airtight homes to delay the need for heating); **thermal storage** (e.g. hot water tanks); **electrical storage**, including vehicle charging and vehicle-to-grid; and the potential impact of **controls** that allow energy use to be synchronised with low carbon generation (e.g. smart thermostats, smart cylinders). Several options are available:

- a **qualitative** assessment (e.g. Smart Readiness Indicator - SRI)
- a **quantitative** assessment (e.g. energy storage capacity, peak demand, proportion of peak demand that can be shifted, etc.).

This must be one of the key area of research and development for SAP 11.

In addition, SAP/RdSAP 11 should have outputs that are directly relatable to smart meter data, including total energy use. Peak demand is a further option.

Thermal storage

- Fabric thermal mass and fabric efficiency
- Hot water cylinders
- Stratification optimised cylinders
- Phase change storage

Electrochemical storage

- Battery storage
- Vehicle to grid storage, including smart controls on vehicle charging

Smart meters and controls

- Smart thermostats
- PV diverters for water heating
- Smart controls for water heating
- Smart control on white goods
- Smart EV charging
- Occupancy detection
- Smart meters/in home displays
- Smart TRVs

Renewable technologies

- PV microinverters and DC optimisers
- Bifacial PV modules

Heat pump technologies

- Individual units
- Exhaust air heat pump
- Hot water heat pump
- Communal systems
- Ambient loop

Electricity tariffs

- Dynamic (Time of Use) tariffs
- Economy 7 tariffs

Key categories of smart technologies and demand management measures, with examples.

Most are taken from the SAP Industry Forum Technologies Report, published in April 2020, which identified key technologies that SAP/RdSAP 11 should be capable of modelling.

Several others have been added as a result of the work contained within this report.

5 SAP/RdSAP can and must play a bigger role in reducing the performance gap

There are several ways in which SAP/RdSAP can help bridge the performance gap between design expectations and actual energy performance during operation.

It is possible to:

- Improve the quality of user inputs
- Improve the methodology, including changes recommended in this report
- Increase the proportion of inputs and outputs which can be checked on completion and in-use
- Become part of a continuous improvement programme, with in-use performance monitoring and a feedback loop at its core.

However, SAP/RdSAP obviously cannot address the performance gap on its own, and it is intrinsically linked to its ecosystem including Building Regulations. In order for changes to SAP/RdSAP to be most effective, they must go alongside actions in several parts of the regulatory framework – see recommendations in Appendix D.

Generally, these recommendations for SAP/RdSAP and its ecosystem would align strongly with the Government’s objective to improve construction quality.

Closing the performance gap: recommended actions in different areas

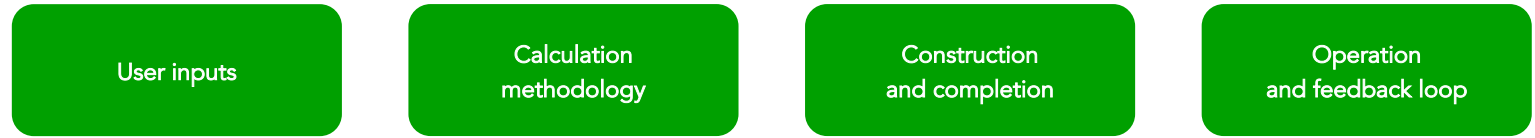

Actions within SAP

- ❑ **Retain the relative simplicity of SAP** as a mostly steady-state monthly tool (dynamic modelling could lead to more errors and less interrogation and “ownership” by SAP users)
- ❑ **Encourage better quality inputs (and more interrogation of them) by SAP users.** This would result from an improved trust in SAP and a more accessible methodology
- ❑ **Reduce the number of default values,** especially for thermal bridges and in RdSAP (e.g. allow measured fabric performance values to be used for existing dwellings)
- ❑ **Allow users to run scenarios outside of the regulatory assessment**

Actions outside of SAP

➤ See Appendix D

- ❑ **Take account of geographical location**
- ❑ **Improve the evaluation of heating systems,** particularly heat pumps and heat networks
- ❑ **Improve the evaluation of domestic hot water use** and the associated energy use
- ❑ **Review the assumptions on occupancy**
- ❑ **Estimate and take better account of unregulated loads,** as they influence regulated loads (space heating) and as the distinction is artificial to consumers, to demand on the grid, and to the climate
- ❑ **Give a more important role to in-use performance monitoring in relation to** the way SAP, Appendix Q and the PCDB methodologies work

➤ See Appendix D

- ❑ **Introduce a penalty in the SAP calculation at the as-built stage unless there is evidence of commissioning results,** for example for ventilation, heating and hot water systems and on-site renewable energy.
- ❑ **Airtightness is currently the only SAP input which is checked at the as-built stage.** FEES cannot be. Consider the introduction of more **SAP inputs or outputs which can be checked** (e.g. Heat Transfer Coefficient, which could be checked through meter-based evaluations, subject to the conclusions of SMETER trials)

➤ See Appendix D

- ❑ **Keep the SAP methodology under regular review** and use lessons from in-use monitoring
- ❑ **Improve the information produced by SAP** (including the EPC report)
- ❑ **Allow users to adjust SAP to their own conditions,** so they can more easily identify under-performance and test options for improvements
- ❑ **Use EUI as main metric, allowing occupants to directly relate actual in-use performance to the one calculated by SAP.**

➤ See Appendix D

The benefits of long-term carbon factors

Long-term carbon factors would have a number of advantages:

1. They are more representative of the actual impact of buildings on carbon emissions between now and 2050.
2. Short term carbon factors need updating very frequently, otherwise they quickly become out-of-date leading to huge errors and negative consequences.
3. Long-term averages are more stable, which helps decisions on design strategies and R&D investment; this also prevents problematic transition periods with abrupt changes and cliff edge effects.
4. There is now reasonable agreement on the future scenarios for the electricity grid and the Government publishes an official forecast¹.

Long-term factors would help accelerate heat decarbonisation

The electricity grid carbon factor would be lower, which would encourage electric heating (including heat pumps).

Why a dynamic carbon factor is not recommended at this stage

The SAP 10.1 proposal to use monthly variations in carbon factor is interesting but it would be more robust if it was considering future likely variations. Going further and using future hourly carbon factors has been considered in this review but is obviously even more challenging.

As the grid decarbonises, relative variations in carbon factors, say hourly, may become more significant, but the absolute variation will reduce overall. In addition, hourly carbon factors would make the evaluation more sensitive to different occupancy profiles, a particularly important factor as homes vary and are expected to be used in many different ways, from the "typical" profile to others becoming more preponderant such as working-from-home and ageing households. Hourly carbon factors are therefore not currently recommended. This could be kept under review, using the gathering of in-use data on demand profiles (at housing stock level), checked against grid carbon factor profiles.

¹ This consensus does not exist for the gas system. While decarbonisation options are being looked into, there is considerable uncertainty on their feasibility and timeframe. Long term projections for the carbon content of grid gas should assume limited decarbonisation, and only be updated with sufficient evidence.

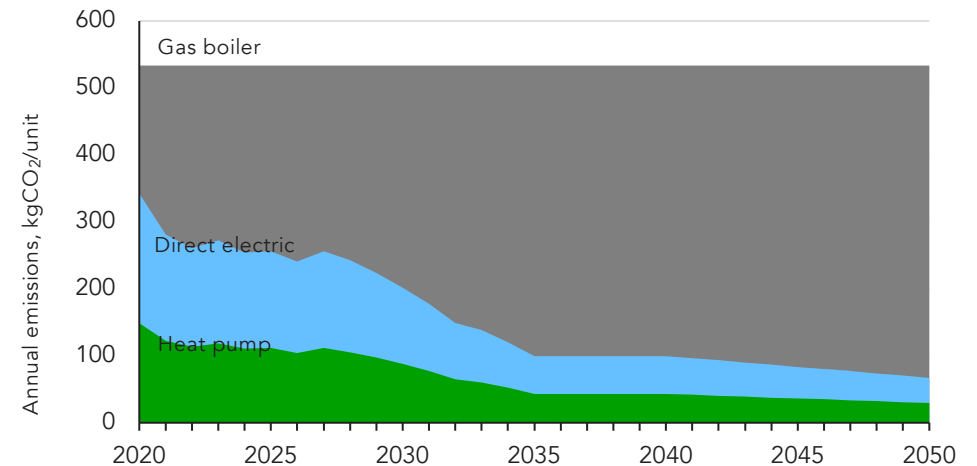

Evolution of annual carbon emissions associated with heating and hot water for a low energy 2-bed flat. While its carbon emissions would remain flat with a gas boiler, they would reduce over time if was heated by direct electric or a heat pump (due to the decarbonisation of the electricity grid). It is clear that using a long term average (e.g. 25-year average) instead of the short term 3-5 year average would be a much better reflection of the actual emissions in the next 20 years.

Current approach

A 3-5-year short term average of carbon factors is used in SAP.

✗ The estimate only reflects the first year(s) of emissions, not an average of the home's emissions in its lifetime, or even just the lifetime of its heating plant.

✗ If these carbon factors are not updated frequently it leads to a very significant issue i.e. rewarding higher-carbon heating system decisions (as in the current situation).

Proposed approach:

A 25-year long term average of carbon factors is used in SAP.

✓ The estimate will reflect the average emissions of the home over the next 25 years.

✓ The system would still benefit from regular updates but they will be less critical and the margin of error much reduced.

7 SAP should remain a steady-state monthly tool, but but with a new module for flexibility

Why the interest in more complex calculations?

SAP currently consists of steady-state calculations that use monthly averages for external temperatures, solar gains, etc. As SAP developed these monthly calculations became informed by hourly or dynamic calculations in the PCDB.

With the energy system becoming more complex and with much more computational capabilities than 20 years ago, the case for more sophisticated calculations is often made (e.g. SAPIF Technologies report), in order to:

- **Assess peak demand and its profile**, and capture the benefits of demand management measures, to support their adoption.
- **Reflect the changes in grid carbon factor throughout the day and/or year.**
- **Calculate energy use more accurately.** This is however balanced by the increased risk of user errors, and the fact that more detailed calculations may be more specific and less robust to a range of scenarios.
- **Assess comfort and overheating more accurately.**

Smaller time step or dynamic?

The term 'dynamic' is often used when actually referring to steady-state calculations, but with a smaller (e.g. hourly) time step. This can be useful for assessing demand profiles and management, but is still a simplification with usually only one time-dependent factor, and change dealt with in a linear way.

A fully dynamic model combines an array of factors which vary with time and each other. This is useful, for example, to assess comfort, or energy exchange between users and with the grid, particularly on large schemes where loads are aggregated.

Recommendation

SAP 11 should strike the right balance between accuracy, robustness, avoiding overcomplexity to reduce errors and encourage 'ownership' among users, and flexibility to innovation and the future energy system. It is recommended to retain the steady-state method with monthly time steps, but to **introduce a 'plug-in' element to model the overall ability of the dwelling to flex when it uses energy.** This could be fully dynamic, or just steady-state hourly, and it could apply year-round or on "worst" and "typical" days.

	Potential accuracy	Potential functionality	Robustness	Ease of use
Steady-state (annual)	low	low	medium	high
Steady-state (monthly)	medium	medium	high	high
Dynamic (hourly)	high	high	low	low

Comparison of the advantages and disadvantages of each calculation approach

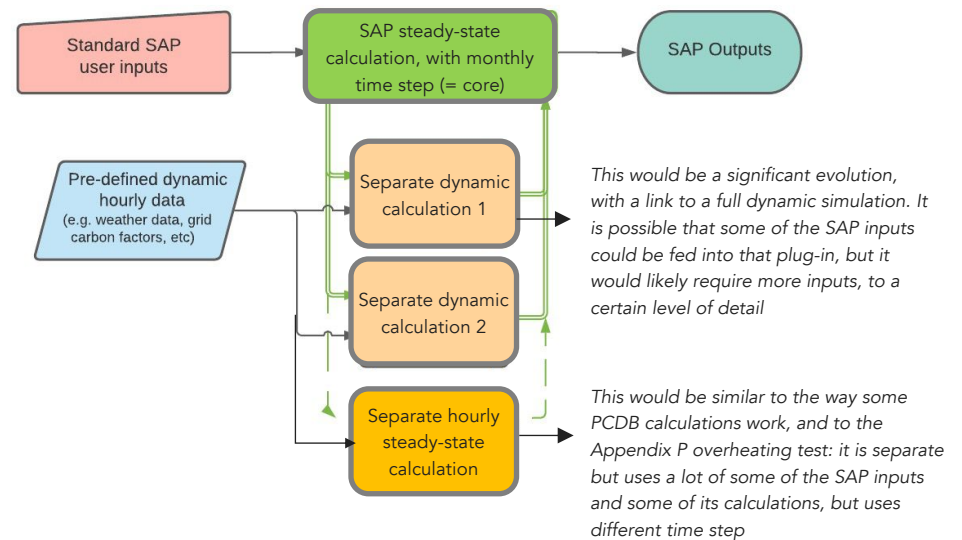

A hybrid calculation process is recommended. It would keep the core of SAP 11 as a monthly steady-state calculation but would also incorporate an independent plug-in which would address specific issues where timing is more critical, in particular evaluating peak demand, time of use and profiles. This could either be steady-state on an hourly time step, or full dynamic simulation modelling. To some extent, this would integrate into SAP what already happens in the PCDB for some technologies.

Many experts we consulted with gave us a similar message:

"SAP must 'tell the truth' in terms of building physics. It is the regulations which can introduce flexibility, restrictions and exceptions".

A fair assessment with consistent and transparent SAP outputs

SAP should assess dwellings on their own merit and in a fair way.

New metrics and clearer links to as-built tests and in-use verification would significantly help with this.

'Fudge' factors which distort the SAP assessment to favour particular technologies or lead to particular outcomes should be removed: SAP should as closely as possible reflect building physics and give results which reflect this.

Where SAP is used for compliance and some adjustment is felt necessary, this should be dealt with via the regulations themselves, to leave SAP outputs as consistent and transparent as possible. For example this may be justified in regulatory transition periods (e.g. phasing out of fossil fuel heating), or in the case of significant and unavoidable constraints, or for wider policy objectives which are considered to require a strategic and whole-system view beyond a building-level SAP assessment.

The huge potential of a non-regulatory use for SAP and RdSAP

The regulatory assessment could be complemented by an unconstrained bespoke module (e.g. 'My Home') allowing users to alter some standardised inputs. This would build on the approach of methods such as the Green Deal Occupancy Assessment. Examples of useful bespoke inputs include:

- **Occupancy patterns and heating set points:** the user could change these to evaluate their potential energy use more accurately and compare it with actual in-use data. Other occupant-related factors could potentially be changed too e.g. frequency of showers / baths, equipment and appliances.
- **Future climate scenarios** e.g. weather data.
- **Uncertainty ranges on inputs in existing buildings** to assess the range of possible outcomes from retrofit works. For example: 15% energy savings from insulation if current U-value is 0.20 W/m².K, but only 10% if U-value is actually 0.15 W/m².K.

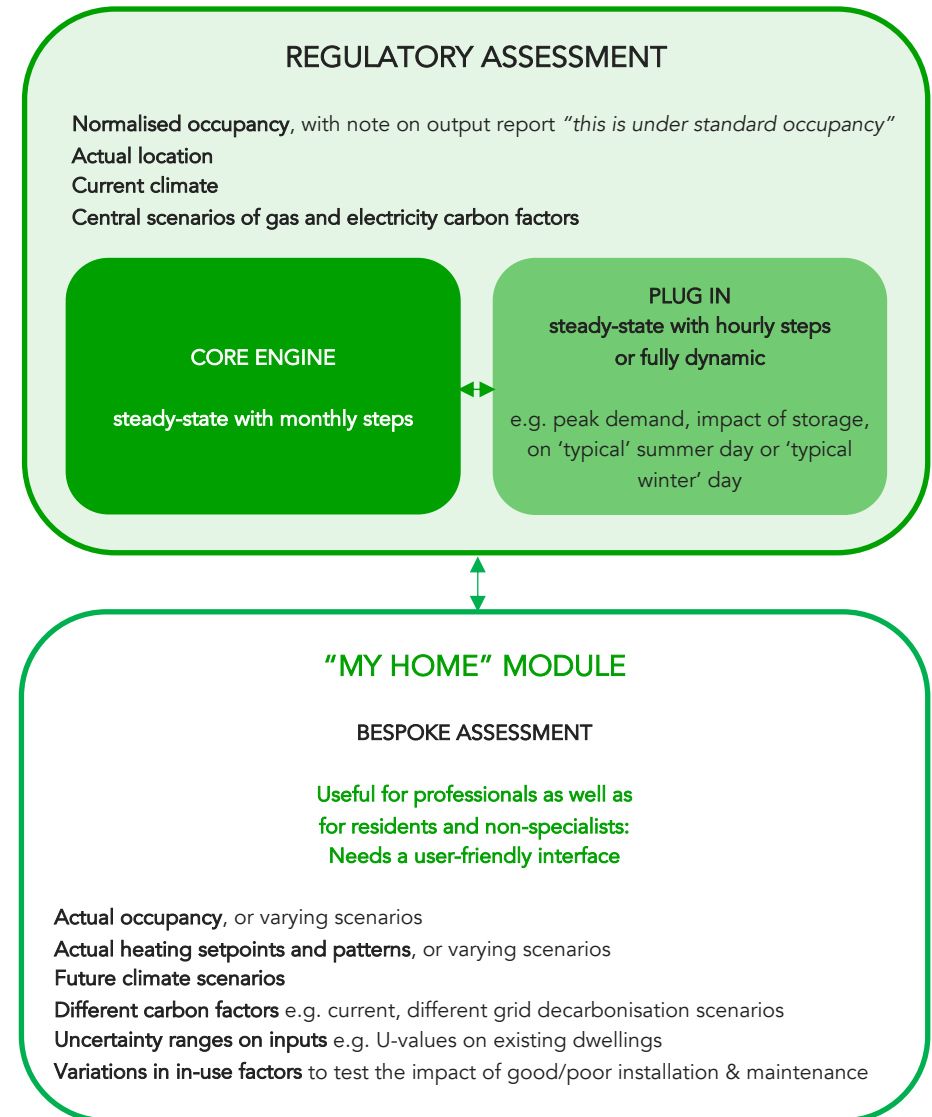

An illustration of SAP with its associated unconstrained module could work to offer much more functionality and clarity, while retaining a similar core calculation method

9 A significant improvement of Appendix Q and the PCDB process is required

Why are improvements to Appendix Q and the PCDB needed?

Our review has identified a number of problematic issues with the Appendix Q and PCDB application process. This involved talking to several applicants who have recently gone through the process, as well as independent academic experts. Key issues identified were:

- No clearly defined application timeframes or processes.
- No apparent fixed level of evidence required, and doubts about the robustness of some testing methodologies.
- General lack of transparency within the application process.
- The financial and commercial risk weighed against the applicant.
- Concerns that applications could be denied at any time without a clear reason.
- A perception that the application process may be too subjective and not structured enough.
- An application process appearing to be too focussed on numerical data with inadequate mechanisms to factor in data from field trials and other empirical data.

SAP plays an important role in the market for energy saving products, therefore it is crucial that the application process encourages the introduction of new innovative technologies rather than creating barriers to their adoption. There is strong empirical evidence to show that products being included in Appendix Q / PCDB significantly increase their uptake in the home building market. In turn this also influences the retrofit market.

Overall, there are valid concerns that the above issues currently restrict the Appendix Q application process to only larger companies which are able to afford the resources and financial risk.

There is obviously a need for the process to be both robust and transparent. Six recommendations for reforming the application process are provided in the adjacent table.

Five recommendations for reforming the Appendix Q / PCDB application process

1. Define and publish a fixed level of evidence required in order to approve a new technology product / category. Consider empirical data (including field trials) rather than only theoretical or lab-based.
2. Form a more transparent application process with more fixed waypoints and clearly defined timeframes.
3. Restructure the payment process to allow for incremental payment of fees against the ongoing progress as waypoints are met.
4. Upon the approval or denial of the technology application, the application assessment and evidence provided should be openly published to provide transparency and demonstrate a fair process. This could even be considered for publication earlier, to open the application to an industry peer-review process; there should be ways to do so while protecting intellectual property and trade secrets e.g. publishing the purpose and stated claims of the technology, the proposed method of evaluation, and the performance data provided, but not publishing protected details of the technology itself.
5. Provide a system for applicants to input / add additional evidence into the application process but prevent applicants from attempting to exert undue pressure or influence on the result.
6. Adopt a continuous or periodic evaluation of the performance of these systems, not only a 'gateway' assessment. This would enable products to be upgraded or downgraded as new data is assessed or the macro situation changes. It would help to maintain robustness and keep all the listed products relevant. It would also help to manage expectations of suppliers in case the performance is downgraded.

10 Overheating: towards a simplified 'flagging system'?

Limitations of SAP 10 Appendix P

The main focus of SAP is energy efficiency. SAP Appendix P provides a test of overheating risk, primarily aimed at reducing the risk of energy use for cooling. It is acknowledged to be simplified and not a comfort test. The key limitations are:

- It is a steady state test using monthly averages.
- It uses a fixed temperature threshold, which over-simplifies comfort.
- It considers the average temperature of a dwelling, instead of individual rooms.
- There is no allowance for the impact of the urban heat island effect and for future changes in climate.
- It makes optimistic assumptions about ventilation rates that can be achieved.

Recommendations

There is a strong consensus that overheating risk is a really important issue, that it will become more so with a changing climate, and that it is not appropriately dealt with currently. However, we found no strong consensus on the best approach to address this issue. The following order of preference appeared though:

1. SAP to provide only a **light-touch risk-based assessment**, and recommend a detailed method in medium or high risk situations - similar in spirit to the Good Homes Alliance overheating tool.
2. SAP test to be **largely retained, with improvements**. This would allow a link to the energy calculation e.g. to account for cooling risk*.
3. Test to change significantly to be **more detailed and complex, maybe dynamic**.

Important note: at the time of completion of this report, MHCLG have published a proposal for consultation on a dedicated regulation on overheating for new dwellings. This should obviously inform the development of SAP 11.

* Recommended improvements under option 2 include:

- Review whether the thresholds allow appropriately for hot spells and adaptability
- Update weather files with latest climate change predictions
- Include an allowance for urban heat island effects
- Review options for considering high-risk rooms (especially bedrooms).
- Include a 'stress test' for high occupancy density / hours.

Key limitations with SAP 10	Why is it a problem?	PHPP	Good Homes Alliance early stage tool	Dynamic modelling under CIBSE TM59
Steady state test using monthly averages	Thermal performance is a dynamic function of multiple variables; furthermore, an average monthly temperature can mask severe hot events, their intensity and duration and the effectiveness of remedial solutions.	Same	Worse – less detailed	Better - dynamic
Based on a dwelling's average temperature	This can be misleading and problematic e.g. bedrooms located on (hotter) top floors or south-facing rooms	Same	Worse – less detailed	Better – detailed per room
Fixed temperature threshold	Depending on where the threshold is, this may over- or under account for our adaptation to higher temperatures .	Similar - but more detailed	Similar - but less detailed	Better – can be used with adaptive comfort criteria
No allowance for urban heat island effect	This can compound overheating issues	Same	Better – taken into account	Same - except for London
No allowance for future climate change	This will compound overheating issues	Similar - but allows scenarios	Same	Better - optional, but recommended
Optimistic assumptions about ventilation rates that can be achieved	Ventilation is a key overheating risk mitigation strategy, so optimistic assumptions can hide serious risks	Similar – but more detailed	Better – taken into account	Very dependent on modeller
Poor consideration of impact of reducing glazing g-value	To pass the test, users often rely on low glazing g-values without considering the impact on light transmittance*, daylight and lighting requirements.	Better – detailed inputs	Worse – not considered	Better – properties have to be entered

Key limitations in SAP 10, and comparison with the other most common methods in the UK

* Actual properties can be entered, but generic ones (Table 6b) are often used.

11 SAP/RdSAP outputs need to be compatible with disclosure and data analysis goals

A key theme running through the recommendations is that SAP/RdSAP needs to be fit for Net Zero Carbon buildings. As well as becoming better at evaluating energy use, so that SAP can become a useful design tool, it is important that SAP/RdSAP enables verification of energy use and thus verification of carbon emission reductions. Smart meters are an important lever here, both for stock-level analysis and policy tracking, and for verification of performance and consumer engagement at the individual dwelling level.

Why compatibility with disclosure is important

SAP/RdSAP must be able to support the evaluation of energy use in operation, thus providing outputs that are compatible with disclosure and data analysis objectives. This is useful for the following reasons;

- Providing outputs that are *compatible with* disclosure and data analysis objectives and enable simple comparisons can in itself drive a focus on actual performance and encourage data disclosure, which is a key part of the Net Zero pathway.
- Results can be benchmarked on a building or stock level, and used to screen homes for poor performance, and direct detailed investigations to homes that are performing worse than predicted.
- Results can be used to create an evidence base to understand how good SAP is at predicting in-use performance and improving the SAP method.

What this means for the tool

It is recommended that the following is provided as outputs of SAP/RdSAP to help as-built checks and diagnostic in use:

- **Annual energy use** broken down by fuel type (kWh/yr)
- An indicator of **space heating demand**
- **Renewable energy generation** (kWh/yr)
- **Demand management metric** e.g. energy storage, peak & time of peak

Where outputs rely on a conversion (e.g. carbon emissions, energy costs), the conversion factors should be very clearly stated in the SAP/RdSAP report.

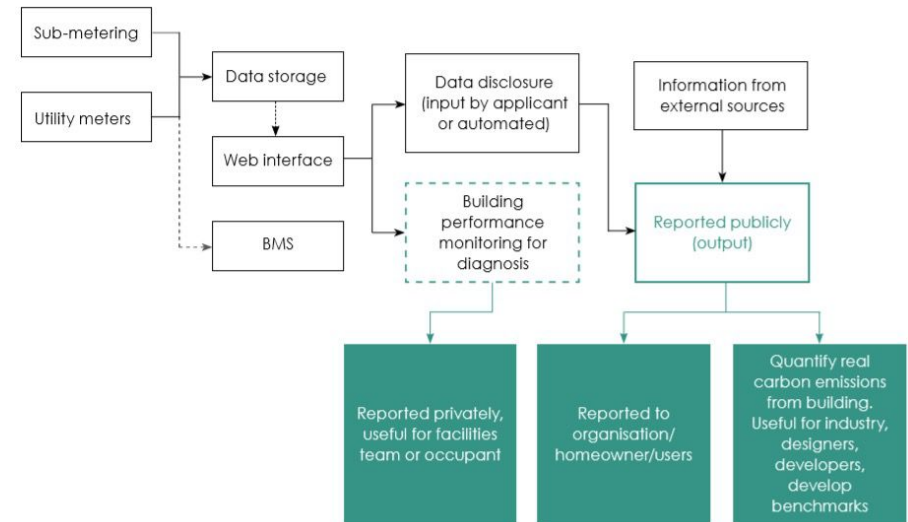

The flow of information from building metering to reporting. The difference between data for disclosure, data that is publicly reported, and data for building diagnosis is shown. (Source: LETI: Climate Emergency Design Guide)



Energy display monitor: users should be able to compare predicted energy use from SAP/RdSAP with the readings from energy meters, display monitors or bills.

12 No more notional building: the introduction of absolute energy use targets

The use of the notional building has been shown to drive perverse behaviours and undermine the policy outcomes that SAP is supposed to support. An improved methodology, alongside outputs selected to meet the priority functions of SAP (e.g. evaluating total energy use) allow an end to the use of the notional dwelling.

This would allow the performance of dwellings to be evaluated against clear set targets which can be linked to energy use and carbon emissions objectives, and to actual in-use performance, a fundamental flaw of the notional building. Where appropriate, these absolute requirements could be stepped over time, providing visibility to industry. Evidence from Passivhaus shows that set targets do not prevent architectural expression. Exceptions will always exist and can be dealt with.

New buildings

The main SAP output, **total energy use** (also referred to as Energy Use Intensity or EUI) should be expressed in **kWh/m²/yr**. Evidence is available on what is achievable, and several regulatory methods have adopted this approach (see section 3). The benefit of having this as the main SAP output over the % improvement over the notional dwelling are summarised on the adjacent figure.

Existing buildings

The realistic “best possible” end goal in terms of **total energy use** is more complex for existing dwellings than it is for new dwellings, and will naturally be more constrained. However a recent review of Building Renovation Passports for the Greater London Authority provides examples of how this could be set. There is a role for SAP to help define this total energy use target and further work is recommended to evaluate the best options among the following:

- A **bespoke total energy use ‘end goal’** defined using the existing dwelling with a whole house package of improvements, which would be ‘optimistic’ but take account of essential constraints e.g. feasibility of internal and external wall insulation. It would indicate a trajectory rather than a regulatory target.
- A **total energy use (EUI) target depending on the archetype**, potentially slightly adjusted by SAP to take account of essential constraints on that dwelling.
- A **space heating demand target** (as this is the primary aim of low-energy retrofit), alone or alongside total energy use. For example, Home Retrofit Planner uses a space heating demand target (20-70kWh/m²/yr, allowing adjustments e.g. form).



- ✗ Is not a ‘physical’ metric
- ✗ Is a concept only experts can understand
- ✗ Cannot be checked during operation
- ✗ Cannot be used to ‘close the loop’ and improve the system over time
- ✗ Does not reward good design e.g. form

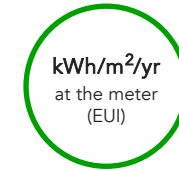

- ✓ Is a ‘physical’ metric which can be measured
- ✓ Can be understood by all professionals, and most consumers
- ✓ Can be checked against in-use data
- ✓ Can be checked to improve SAP prediction of energy use over time

The relative metric introduced by the Notional Building approach (i.e. % improvement over Part L) has a number of unintended consequences which hinder the continuous improvement of building design, consumer trust and SAP itself.



New build:

- ✓ What constitutes best practice is well understood and could be translated into a total energy use (EUI) target. This could incorporate adjustments per broad climatic zone.
- ✓ A small number of exceptions such as very constrained sites could be allowed for if the set total energy use (EUI) target was deemed too onerous. These exemptions should have to be justified, so that they are only claimed when truly needed.



Existing buildings:

- ✓ A more thorough review is needed to assess the best approach to target setting.
- ✓ There is probably more of a role for SAP to help with target setting than in new dwellings, to take account of existing dwelling constraints.
- ✓ In any case, SAP should show an ‘end goal’ representing low-energy and low-carbon retrofit for that home, regardless of the applicable regulatory target at that point in time

Recommended approach to target setting in SAP11. This should come alongside secondary metrics – see Recommendation 13.

13 New metrics for Net Zero Carbon (and not primary energy)

The metrics used in SAP must reflect its priorities. They must be easily linked to actual in-use data, reflect performance of the building itself to encourage action, and support the transition to Net Zero Carbon. They should also make use of important developments in testing and in-use data (as described in chapter 1). The review of best practice worldwide supports this and provides examples.

Main metric: total energy use in kWh/m²/yr

For these reasons, the recommended main metric is **total energy use** – expressed as Energy Use Intensity (EUI, in kWh/m²/yr). This is independent from changes to the energy system and prices, is easy to understand for consumers, enables a direct feedback loop from metering, and allows comparisons between buildings.

Secondary metrics

They would address other important functions for SAP, and offer several advantages for tracking and implementation of a range of policy objectives:

- **Carbon emissions**, in kgCO₂/m²/yr. SAP is central to delivering Net Zero, and it needs to take account of the carbon impact of energy consumption as well as energy consumption itself, for the transition away from gas, oil and other fossil fuels. This should be based on long-term carbon factors (20-30 years).
- **Space heating**: heat demand is a major challenge of Net Zero policy, and it is the domestic energy use most directly influenced by SAP. In retrofit, space heating may even be considered as main metric. There are a number of options; the most appropriate are considered to be space heating demand, which has a track record in Passivhaus, and Heat Transfer Coefficient (W/K, or normalised per m²), which can be verified (subject to SMETER conclusions).

Other useful outputs

In addition, SAP can produce a range of other useful outputs, in particular:

- **On-site renewable energy generation**, as kWh/m²/yr (floor area or footprint), or possibly becoming a key metric.
- **Energy costs** (£/m² or dwelling /yr), total or heating costs specifically
- **Demand management**: this needs to become an output, at the very least to inform future developments. Options include peak demand (as W/m²), Smart Readiness Indicator, energy storage capacity.

Main metric
Total energy use (kWh/m²/yr)

Secondary metrics

- Annual carbon emissions, kgCO₂/m²/yr
- Space heating e.g. HTC, demand

Other useful outputs

- Renewable energy generation ((kWh/m²/yr)*
- Demand management (e.g. energy storage capability Smart Readiness Indicator
- Energy costs

Key metrics for Net Zero Carbon, energy efficiency and reducing demand, heat decarbonisation

The key metrics from SAP should reflect its priority objectives, but additional outputs must be available to serve multiple goals. * Renewable energy generation could become a key metric

	Heat Transfer Coefficient	Space heating demand	Fabric Energy Efficiency (FEE)
Accounts for purpose ventilation	No – in typical co-heating tests. Yes - in SMETER HTC in use	Yes	Yes, but assumes set natural ventilation system
Accounts for internal gains	No	Yes; mix of actual and set assumptions	Yes, but assumes set internal gains
Accounts for solar gains	No	Yes	Yes, but assumes set location, not actual
Accounts for heating system	No	No, but set 20°C heating set point	Mix: system responsiveness, set heating setpoint
Verifiable as built or in-use	Yes - co-heating test, disruptive. Alternatives tbc with SMETER, currently only for individual homes	No (or only approximately)	No, as calculated under theoretical assumptions
Calculated by SAP 10	Yes, incl. ventilation. Box 39, not an output	No	Yes **
Comments	In W/K (or W/m ² /K) so performance outcome varies with climate	Set performance outcome (kWh/yr/m ²). Used in Passivhaus	Includes cooling, if provided

** As per response to Future Home Standard consultation, or another fabric / space heating metric

Summary of main options for SAP 11 metrics related to space heating

14 Better governance: a modular architecture and an evidence-based culture

A clear purpose

The priority functions of SAP should be clearly stated upfront in the guidance document, and when users launch the software. This should be accompanied with a clear statement on what SAP/RdSAP can and cannot do, in particular:

- Its limitations to look at holistic issues such as air quality, comfort and moisture: simplicity and robustness are key requirements of SAP, and in that context it is not realistic to expect it to deal reliably and in detail with a whole range of issues beyond energy use. This should be made clear to users and residents.
- Its limitations to exactly represent energy use for each dwelling: it is not realistic to expect regulatory calculations to do so and some form of normalisation is necessary. This should be made clear to users and residents. In addition, an unconstrained use outside of regulation would provide more functionality and clarity – see recommendation 8.

An open architecture with different modules

The anatomy of SAP diagrams (Section 6) should be made public. They could become a digital platform, allowing users to explore different ‘modules’ at gradual levels of detail, along with the open-source methodology. This would help a more continuous development of SAP with modules upgraded separately. This would help new technologies but also help spot and fix issues quicker.

A complementary idea is to create a shadow dynamic model of SAP, which would be open sourced and where users, outside regulatory purpose, could test modifications to the calculations, compare them with the regulatory model etc. This could help identify future developments and/or test products dynamically.

An evidence-based culture

The assumptions and evidence base behind each module should be more easily available (e.g. as for Energy Plus). This should be kept under regular review, against as-built and in-use information, utilising new data and testing capabilities.

In-built assumptions and rules of thumb, such as the “divide by 20” rule on airtightness and infiltration, should be clearly stated in the methodology, with a link to the evidence base. They should be part of the log of issues needing regular review, unless the evidence base is robust and widely accepted.

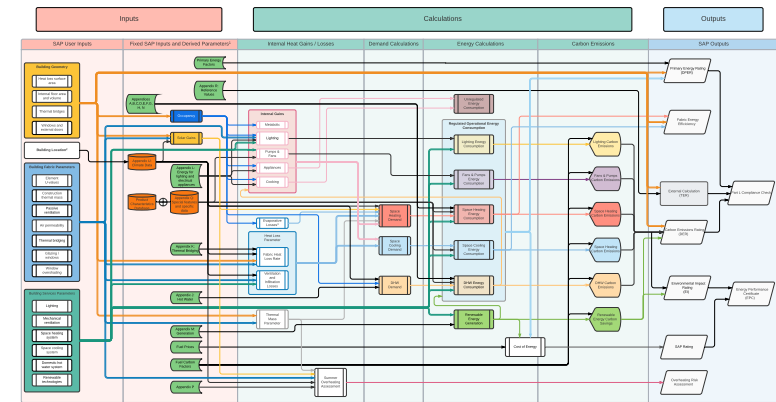

The SAP architecture should be based on modules which can be updated independently. This architecture and the methodology should be open source – see diagrams in larger size in section 6.

BETTER USE OF IN-USE DATA

Using building- and stock-level data

- Review in-use performance against SAP calculations, for whole buildings and for individual products and systems
- Review in-use data on SAP inputs and assumptions e.g. occupancy profiles
- Adjust the method where required

DYNAMIC SAP SHADOW MODEL *(outside of regulatory purposes)*

Open-source For use by industry and academia

- Tests potential modifications
- Compare steady state vs dynamic results
- Identify the need for future developments.
- Tests products dynamically e.g. to inform Appendix Q / PCDB process

Two elements which would help the continuous development of SAP, with engagement from industry and academic: a dynamic shadow model, and better links to in-use data

The SAP rating is related to the total energy cost by the equations:

$$ECF = \text{deflator} \times \text{total cost} / (\text{TFA} + 45)$$

$$\begin{aligned} \text{if } ECF \geq 3.5, & \quad \text{SAP 2012} = 112.8 - 119.1 \times \log_{10}(ECF) \\ \text{if } ECF < 3.5, & \quad \text{SAP 2012} = 100 - 14.85 \times ECF \end{aligned}$$

Extract from SAP 10.1: where do factors and thresholds behind the SAP rating come from? In-built assumptions can look arbitrary as they are often hard to trace back. The rationale and evidence base behind SAP should be clearer and easier to access.

15 New EPC ratings from SAP/RdSAP to support Net Zero and fuel poverty objectives

SAP 11 can continue to deliver EPCs ... but reform is needed

"It remains important that EPCs are reformed to ensure they drive the energy efficiency measures needed." CCC 6th Carbon Budget report, December 2020

"(We) will deliver an EPC that engages consumers and supports policies to drive action." EPC Action Plan, December 2020.

Even with SAP/RdSAP changing to energy use as its main metric, it would still be able to produce other outputs, including energy costs. Keeping the EPC rating as a cost rating is therefore in theory possible. However, this SAP/RdSAP11 review and the government's EPC Action Plan provide a unique opportunity. A more fundamental change is recommended to drive energy efficiency and engage consumers: **the EPC rating should be based on energy use, not energy costs.**

Aligning EPC ratings with Net Zero and fuel poverty objectives

Of the three factors behind fuel poverty, energy use is the most relevant for SAP/RdSAP (compared to energy prices and income). This is typically how EPCs are used in fuel poverty policies: to identify the buildings most in need of improvement. An **energy use rating** would therefore give a much more suitable (and reliable) indicator of the need and opportunity for intervention. It would greatly improve the functionality of EPCs as an indicator of a property's energy performance (both for carbon and fuel poverty objectives) and its potential for retrofit of energy efficiency and low-carbon heating measures.

EPC reports to complement the approach set by the ratings

We also recommend that the EPC report clearly show the key SAP/RdSAP outputs:

- Total energy use
- Breakdown of energy use per fuel (for properties that are not all-electric),
- Space heating demand
- Carbon emissions. Carbon could also be reflected in the ratings e.g. top rating only awarded to homes compatible with Net Zero i.e. not using fossil fuels.
- Energy costs could still be estimated and shown on EPCs, possibly under different tariffs e.g. average and Time of Use tariffs.
- Solar energy generation.

Change EPC ratings to what they should reflect, and what SAP can best evaluate: Energy use.

The terms 'energy rating' and 'energy efficiency rating' are misleading if they continue to refer to energy costs as they do currently

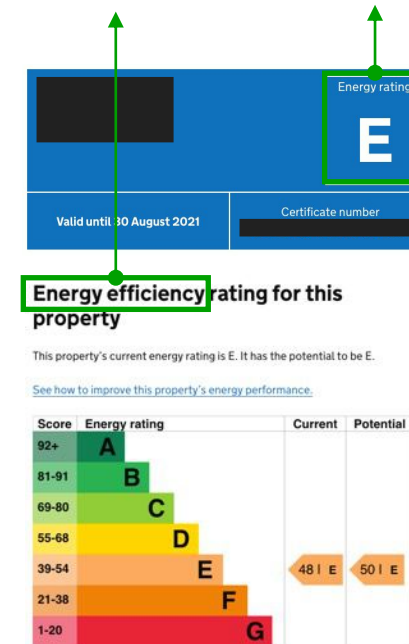

Support the low-carbon heating transition.

The EPC should prominently state whether the heating system is already low-carbon, or uses fossil fuel, as moving away from fossil fuels is an essential action for Net Zero.

Environmental impact of this property

One of the biggest contributors to climate change is carbon dioxide (CO₂). The energy used for heating, lighting and power in our homes produces over a quarter of the UK's CO₂ emissions.

An average household produces	6 tonnes of CO ₂
This property produces	5.6 tonnes of CO ₂
This property's potential production	5.5 tonnes of CO ₂

By making the recommended changes you could reduce this property's CO₂ emissions by 0.1 tonnes per year. This will help to protect the environment.

Environmental impact ratings are based on assumptions about average occupancy and energy use. They may not reflect how energy is consumed by the people living at the property.

Heating use in this property

Heating a property usually makes up the majority of energy costs.

Estimated energy used to heat this property

Space heating	19747.0 kWh per year
Water heating	2145.0 kWh per year

Give prominence to heating to highlight potential for retrofit.

Space heating should be displayed on the first page, alongside carbon emissions (not on page 5 of 7 as in this example).

Illustration of recommended changes to the information shown on EPCs

This only covers the information which is a direct SAP output, not other aspects of EPCs such as the recommendations. (Using an anonymized EPC downloaded from the register in December 2020)

16 SAP should be fully integrated in the digital age

Bringing SAP into the digital age

SAP and the methodology underpinning it were created at a time when computers were not yet widely used. The ability to undertake the calculations by hand was actually one of the key constraints which informed its development. This quest for simplicity was and still is very beneficial. However, times have changed and the digital revolution is now well under way. It is therefore crucial that a new constraint is placed on the development of SAP, this time for its integration in the digital age. This should form part of the brief and should be considered in detail.

Making valuable data from SAP accessible

The most important aspect of this digital integration relates to the data embedded in and created by SAP. The efforts made in the creation of a SAP assessment by developing the correct inputs (e.g. wall type and U-value, ventilation system, window types, heating system) represent quality granular data which tell us a lot about a dwelling's characteristics and its potential performance. The outputs of SAP, and particularly the calculated energy use also represent a very useful source of information. Data from SAP can be extremely useful for a range of users at the building and stock level and should be made available to them, in strict compliance with data protection regulations:

- **Homeowners** who could have this data stored in the dwelling's digital logbook.
- **Energy assessors** who could access data from previous SAP assessments and update it accurately instead of starting from scratch each time.
- **Government and local authorities** who could use it to track progress towards Net Zero generally but also progress on energy efficiency improvements, fuel poverty objectives, decarbonisation of heat, etc.
- **Researchers** who could undertake intelligent and thorough data analysis.
- **Supply chain:** under certain conditions, some of the data could be made accessible to the supply chain who will play a key role in delivering solutions.

Towards the end of RdSAP

RdSAP is, as its name suggests (i.e. Reduced data SAP) a process to fill a data gap, using a combination of site visits and assumptions. The digitisation of SAP and of building data offers the opportunity to move to full SAP, one dwelling at a time.

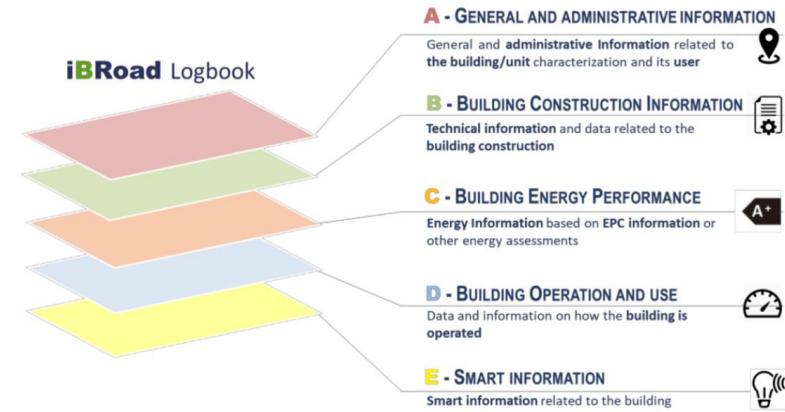

The data logbook is a key component of the Building Renovation Passports, leaving information 'attached' to each dwelling even if it changes ownership. SAP can play a key role in creating some of the logbook data © iBRoad

Main inputs

Regions	Wales	x	v
Property type	All	x	v
Property form	All	x	v
Floor area bands	All	x	v

Optional inputs

Year	2012	x	v
EPC band	All	x	v
Building age	All	x	v

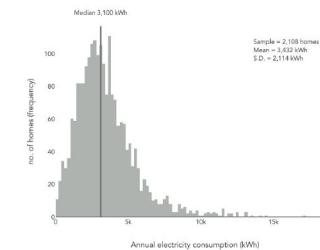
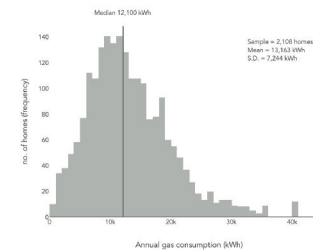

The availability of (anonymous) SAP output data (e.g. window type, energy use, heating demand) would enable very useful analysis on the dwellings' characteristics or their predicted energy and carbon performance, particularly at stock level. See example of the above domestic energy database tool using NEED, showing energy use for a range of dwellings © Etude

17 Location should be taken into account and not normalised as it is now

SAP is using an inconsistent approach: it should change

Historically, SAP has disregarded geographical location from the energy/carbon calculation to provide a consistent assessment irrespective of location.

Currently SAP 10.1 *Appendix U: Climate Data* provides monthly external temperature, wind speed, solar radiation and longitude/altitude data for 21 regions of the UK. Location is factored into the overheating assessment and PV output calculations, which do have an impact on the Part L results, and for the energy use and costs shown on EPCs (but not the EPC rating itself). However, it is **not used** for calculating the energy demand and therefore the DER/TER, Fabric Energy Efficiency, and the SAP and environmental impact ratings.

By not accounting for the geographical location of the dwelling, the accuracy of the calculation is detrimentally impacted: the modelled climate conditions can be significantly different from the actual conditions.

SAP 11 should reflect the location

Housing developers and builders should be encouraged to design and construct buildings which are the right responses to their local climate conditions and SAP must play a role in this. For example, it could help incentivise improved U-values and airtightness in colder regions and represent more accurately the benefit of utilising passive solar gains in sunnier regions.

We therefore recommend that SAP and RdSAP 11 factor in local geographical climate conditions, including when determining energy demands for Part L and for EPCs. The implication of this is that a home built in Scotland will have to be more insulated than a house in the South of England. We do not think this is a problem: it is a reflection of a physical reality, just as vernacular styles have developed over centuries to respond to local conditions. If this is not done, it is consumers who will pay the price as residents in the North of the UK could have to pay more for their heating than those in the South. This is neither acceptable nor fair.

Taking account of geographical location will improve accuracy and consistency of performance outcomes for energy, carbon and comfort.

This would also enable future development, including the consideration of rainfall and wind-driven rain for insulation installations on retrofits. Finally, the use of future weather data also needs to be a key consideration in the review of SAP/RdSAP 11.



SAP 10 Appendix U: Climate Data regions. We recommend that all calculations are performed using the relevant regional location.

Experts have pointed us to the need to pay attention to border or postcode effects; this is an example of exception which does not need to set the rule e.g. it could be dealt with by introducing some flexibility in border areas, to avoid closely located homes being subjected to different requirements.

18 Domestic hot water should be modelled more accurately

Domestic water heating can use as much energy as space heating

In existing dwellings, domestic hot water typically accounts for less than 20% of total heat demand. In a Net Zero Carbon home it could equal or even exceed space heating demand. We therefore recommend that a similar degree of attention is given to the assessment of domestic hot water demand in SAP/RdSAP 11. It is important if SAP/RdSAP is to differentiate accurately bad and good system design and specification.

Hot water storage and demand management

Domestic hot water peak loads can be up to ten times space heating peak loads. This has significant implications for the design of low carbon heating systems such as heat pumps and direct electric heating, as well as for the wider electrical network.

The design of domestic water heating systems provides significant opportunities to reduce peak load (which would reduce impact on the electricity grid) and to synchronise energy use for hot water with times of high renewable energy generation. A hot water tank can easily use excess wind energy from the grid, or rooftop solar energy, to store up enough hot water for the rest of the day.

Recommendations

The draft SAP 10.1 proposes to take account of shower flow rates, which is a positive development. To further recognise the importance of domestic hot water systems and better assess good design it is recommended that SAP 11 should:

- **Enable users to input the flow rates of** other water fittings (e.g. taps) unless it is demonstrated that it would not justify the increased input requirements.
- Include the **volume of water within dead legs**, as this has an impact on energy use and good practice design can reduce it.
- Provide more detailed inputs for **hot water recirculating systems**, including insulation thickness and conductivity, and insulation of pipe supports.
- Review and confirm the impact of **Waste Water Heat Recovery Systems**.
- Model the impact of **hot water storage and smart controls** on demand reduction and management.

	Existing dwelling (kWh/m ² GIA/yr)	Typical new build (kWh/m ² GIA/yr)	Ultra-low energy new build (kWh/m ² GIA/yr)
Space Heating	128	68	13
Domestic Hot Water	35	23	15

Ultra-low energy new dwellings could use more energy for water heating than for space heating, reversing historical trends. Typical figures based on BSEN-8558 (2011), BSRIA Rules of Thumb, CEN Mandate 324 (2002), studies by the Energy Saving Trust and United Utilities, and Etude modelling for representative homes across a wide range of projects.

Methodology	Existing dwelling (kW)	Typical new build (kW)	Ultra-low energy new build (kW)
Based on Hot Water Association Design Guide 2018	42	33	25
Detailed analysis (bath)*	47	22	22
Detailed analysis (shower + sink)**	36	29	22
With storage	6	3	2

Peak demand for domestic hot water in existing dwellings compared to new builds. Figures based on Hot Water Associated Design Guide and first principles analysis using typical flow rates and temperatures. Storage is key to reduce peak demand.



+ **IFTTT**

The humble hot water tank has excellent potential for storage of excess renewable energy generation at scale when coupled with smart controls such as IFTTT (IF This Then That, a web-based service that allows users to create chains of conditional statements).

* assuming a bath filled from a single tap delivering 15 l/m at 60°C for existing dwellings, and a mixer tap delivering 12 l/m at 41°C for typical and ultra-low energy new dwellings.

** assuming coincidental demand from a shower and a kitchen sink. Shower flow rates vary from 12l/m in existing buildings to 6 l/m in ultra-low energy new dwellings.

SAP/RdSAP should better model the energy performance of ventilation systems

SAP/RdSAP has a critical role to play to encourage good practice and reduce the risks of excessive energy use and poor air quality. Currently, it may inadvertently not incentivise the most energy efficient or appropriate ventilation systems.

SAP should reflect MVHR as a key component of tomorrow's homes

Traditionally, dwellings in the UK have relied on natural ventilation, sometimes with local mechanical extract units, and this is reflected in SAP by extensive options and configurability. However, for the vast majority of new dwellings Mechanical Ventilation with Heat Recovery (MVHR) is becoming the norm and a critical component for energy efficiency and air quality. Options and configurability for MVHR in SAP are fairly limited. SAP should be able to reflect best practice for the design, specification and installation of MVHR as a system, not just a unit. It should:

1. Take account of **intake and exhaust duct runs** to outside to reflect their impact on heat loss, thus incentivising good installations close to an external wall
2. Assess accurately (and therefore reward) the use of **rigid ductwork** throughout
3. Reflect **installation and commissioning** in order to improve energy efficiency, reduce noise and mitigate the performance gap e.g. penalty in the calculation unless evidence of commissioning is provided.
4. Review the **SAP Appendix Q database** to ensure it accurately reflects actual in-use performance e.g. including filters, now increasingly installed in urban areas.

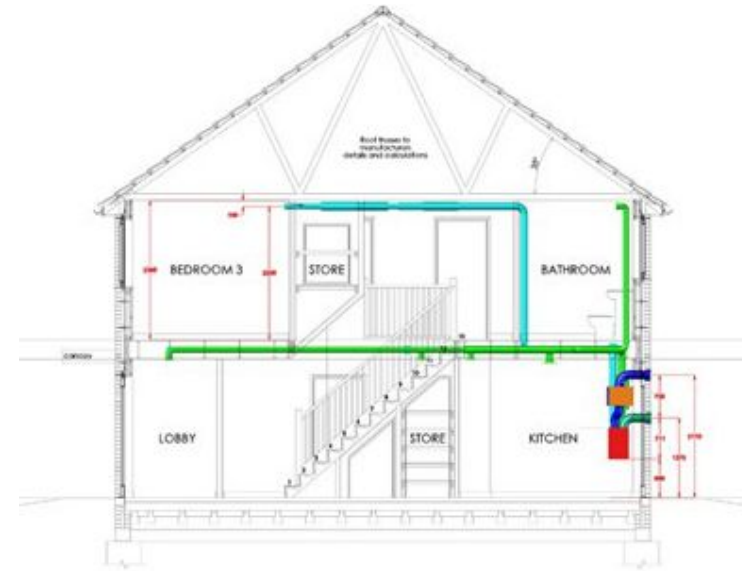

Diagram of good practice MVHR design: the MVHR unit is located close to an external wall.

Review how ventilation is addressed in existing dwellings

There are several points to address: taking better account of airtightness: this should be an input in RdSAP, and tested values should be allowed; reviewing whether / how to prompt for an assessment of whether mechanical ventilation is needed due to airtightness improvements; offering more options representative of the range of systems retrofitted in existing homes.

Review assumptions on infiltration and ventilation rates

The in-built assumptions and rules of thumb (including the "divide by 20" rule linking airtightness to infiltration) need to be reviewed and re-validated or revised if needed, so that SAP/RdSAP assesses options on a fair basis.

Type	Index number	Status
Centralised MEV and MVHR systems	500481	Normal
Brand	Model name	Model qualifier
Zehnder	ComfoAir QH50 GD DT	
System type	balanced whole-house mechanical ventilation with heat recovery	
Duct type	rigid	
Minimum duct size	125 mm diameter or 204 x 60 rectangular or larger	
Original manufacturer name	Zehnder Group UK Ltd	
Current manufacturer name	Zehnder Group UK Ltd	
Manufacturer address	Concept House Welchmoor Point Camberley Surrey GU15 9AD	
Manufacturer phone	01796 483884	
Manufacturer website	www.zehnder.co.uk	
First year of manufacture	2016	
Final year of manufacture	current	
Summer bypass	yes	
Integrated to exhaust air heat pump	No	
Entry updated	16/11/2016 14:15	

Kv/wet rooms	SFP (W/s) (200)	Efficiency (%)	SFP (W/s) (2012)	Efficiency (%) (2012)
n = 1	-	-	0.54	95%
n = 2	0.58	96%	0.83	95%
n = 3	0.48	95%	0.85	94%
n = 4	0.49	95%	0.82	94%
n = 5	0.53	94%	0.73	93%
n = 6	0.60	94%	0.86	93%
n = 7	0.68	94%	1.04	93%

In-use factors
In-use factors are shown as multiplying factors for SFP or MVHR efficiency

	Default In-use Factors					Last updated
	SFP Flexible duct	SFP Rigid duct	SFP No duct	Efficiency Uninsulated duct	Efficiency Insulated duct	
MEV centralised	1.70	1.40				16/12/2011 08:52
MEV decentralised	1.45	1.30	1.15			12/05/2007 09:52
MVHR	1.70	1.40	0.70	0.85		16/12/2011 08:52
Default	2.50	2.50	2.50	0.70	0.70	15/10/2007 12:16

	Approved Installation Scheme In-use factors					Last updated
	SFP Flexible duct	SFP Rigid duct	SFP No duct	Efficiency Uninsulated duct	Efficiency Insulated duct	
MEV centralised	1.60	1.30				16/12/2011 08:52
MEV decentralised	1.45	1.30	1.15			12/05/2007 09:52
MVHR	1.60	1.25	0.70	0.85		16/12/2011 08:52
Default	2.50	2.50	2.50	0.70	0.70	15/10/2007 12:16

Example of Appendix Q MVHR database entry

20 Thermal bridges: good practice should be rewarded (and bad practice penalised)

Thermal bridges are important, but SAP is used to 'trick the system'

The importance of thermal bridges for performance and built quality has increased:

- As heat lost through other elements reduces with better insulated walls, triple-glazed windows, etc. junctions tend to become a weaker point in the envelope.
- The rate of heat loss through junctions, measured as their Psi-values, is higher in well insulated dwellings.
- Thermal bridging is even more important in retrofit, where it can be complex to avoid and lead to serious issues with condensation and material degradation.

Unfortunately design and construction teams generally do not know 'what good looks like' in terms of thermal bridges and how to ensure a good level of thermal performance for junction design and construction. As a result some SAP users bypass this important consideration by using default values which do not represent actual performance and, most importantly, does not improve the status quo.

Accepting the complexity of this issue, and embracing it

Approaches in SAP which underestimate the impact of thermal bridging perpetuate issues with **modelling** and most importantly with **design and construction**, without sufficient incentives for designers and builders to improve the thermal performance of junctions. Three changes are recommended:

- **Promote accurate length measurement at all stages.** Thermal bridge measurement is one of the most time consuming activities in a SAP calculation and is often 'avoided' pre-planning by SAP users who use the y-value input as a shortcut. This should not be an option anymore: the y-value must only be an indicator, not an input.
- **Make default values more penalising.** Other energy modelling methods prevent the use of default values (forcing the use of specific Psi-values) and/or have a more conservative assessment of their impact. This incentivises improvements.
- **Databases.** The cost of thermal bridge calculations can be significant. The development of databases (private or public) has significant potential to bring costs down and it should be considered again. They should become a priority and be both sustainable and pragmatic, with a strong connection to buildability and construction checks. Robust details could be considered as a case study.

The transmission heat transfer coefficient associated with non-repeating thermal bridges is calculated as:

$$H_{TB} = \sum(L \times \Psi) \quad (K1)$$

where:

L is the length of the thermal bridge, in metres, over which Ψ applies
 Ψ is the linear thermal transmittance ($W/m \cdot K$)

The length of thermal bridge is obtained from the architectural drawings.

The linear thermal transmittance value, Ψ , associated with additional heat loss via junctions and areas around openings is obtained by using two-dimensional numerical modelling. For further information see BRE Information Paper IP 1/06. For the conventions used for numerical calculation of linear thermal bridges refer to BR 497 - Conventions for Calculating Linear Thermal Transmittance and Temperature Factors.

Some SAP calculations might be done where the y-value is pre-calculated for a particular house or where the details of the thermal bridges are not known (existing dwellings); in such cases use the following formula:

$$H_{TB} = y \sum(A_{exp}) \quad (K2)$$

where;

A_{exp} is the total area of external elements calculated at worksheet (31), m^2
 y is the pre-calculated value derived outside of the SAP calculation obtained by dividing the calculated H_{TB} by the total area of exposed elements of the dwelling, $\sum A_{exp}$, which includes all exposed elements but not the party wall. Or in the case of buildings where details of thermal bridges are unknown use a default of $y = 0.20 W/m^2K$.

There are several possibilities for specifying the thermal bridging in SAP:

- 1) Details from a government-approved source involving independent assessment of the construction method of junctions and provision of Ψ -values for that junction.
- 2) Details from a reputable non-government database containing independently assessed thermal junction details.
- 3) Using Ψ -values calculated by a person with suitable expertise and experience using the guidance set out in BR 497, and BRE IP 1/06.
- 4) If none of the above applies use equation (K2), with $y = 0.20 W/m^2K$.

The above extract of SAP 10.1 (September 2019) provides the four options available to SAP users to specify thermal bridging in SAP. Option 4 used to allow the use of a y-value of $0.15 W/m^2K$ (SAP 2012). It has been increased to $0.20 W/m^2K$ (SAP 10.1) but is still likely to represent an underestimate.

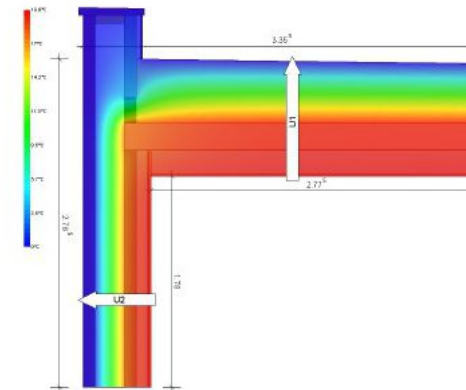

Thermal bridge calculation of a parapet detail. Such calculations can cost more than £100 for each detail and there could be more than 20 details on a project. Public and private libraries of calculations could significantly help to improve quality and promote better practice.

21 SAP needs to better reflect all energy uses, including cooking and white goods

Capturing unregulated energy uses

The separation between regulated and unregulated loads is artificial. It may have made sense at some point but this is no longer the case with the Net Zero Carbon target, the importance of demand reduction and management, the use of on-site renewable energy and the importance of these uses in the home energy balance. In addition, unregulated energy use is not metered separately and it is an integral part of energy use for residents. Most unregulated energy uses also turn into internal gains, which affect space heating demand. It is not a coincidence that tools such as PHPP and Minergie with a good track record for the evaluation of space heating demand also evaluate unregulated use.

Types of unregulated loads to include in the energy assessment

We recommend to **require detailed inputs** for at least cooking and white good appliances in the SAP evaluation of energy use, and default values where none are installed. Electrical equipment and EV charging should also be considered:

- **Cooking and white good appliances** (e.g. fridge, freezer, washing machine, dryer, dishwasher, etc.). These may not be installed by the developer, but often are. They represent a significant area of energy use in a home.
- **Electrical equipment** (e.g. TV, router, laptop, etc.). These are generally not installed by the developer. They can represent a significant energy use which could be estimated based on floor area.
- **EV charging**. These will be increasingly installed by developers in the future. They can represent a very significant energy use. We recommend more research in this area before deciding whether to incorporate it into SAP, and if so how.
- **Plug lighting**. It is generally not installed by the developer. It represents a very marginal proportion of energy use.

The argument against evaluating this energy use is weak

The argument often used against the evaluation of unregulated energy uses is that one cannot predict how residents will use them. We consider this argument weak: it is possible to estimate how much energy, on average, these appliances would use, and there is no fundamental difference with estimating how much energy residents use for, say, lighting or hot water, which SAP/RdSAP does.

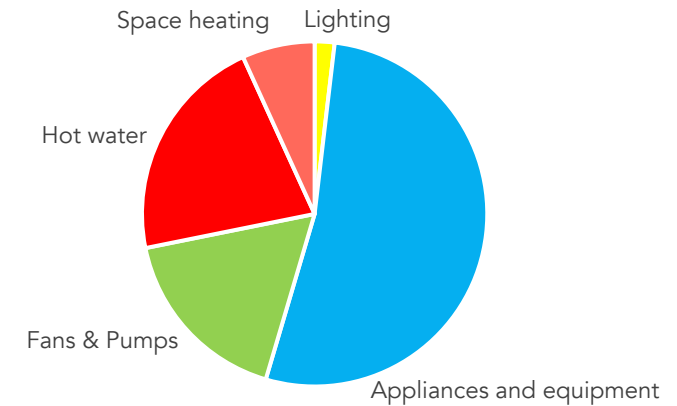

In an ultra-low energy house heated by a heat pump, appliances and equipment can represent half of the energy consumption. They must be assessed as accurately as possible by SAP, even if their energy use does not become 'regulated' by Building Regulations.



If users could input the energy rating and/or energy use of each white good appliance, it would further incentivise the selection of energy efficient products (e.g. A+++ washing machines and fridge-freezers)

22 Occupancy: the standardised assumptions should be re-validated

Interrogating the assumption on occupancy

The future number of occupants in a home is generally not known during design and construction of a new dwelling. Even when it is, this only applies to the first occupants and may change in the future. It is also important to 'normalise' occupancy to avoid this parameter (which cannot be checked) being 'manipulated'. It is therefore necessary for SAP to make an assumption on occupancy.

The SAP calculation assumes a number of occupants for the assessed dwelling based on floor area. The adjacent chart shows that the resulting assumed number of occupants plateaus at around 3 occupants after approximately 125 sqm.

We have carried out a high-level initial comparison against actual occupancy in an average size dwelling (see Appendix C). SAP gives a close-enough, slightly over, estimate in England (2.67 against actual 2.36-2.70) and Northern Ireland (2.75 against actual 2.40-2.50). On average therefore, the SAP assumption seems reasonable. However, averages can mask large discrepancies e.g. occupancy is likely to be higher in new homes and in flats; over-occupancy is common in London and the South East, while under-occupancy is common in ageing households.

Recommendations for the regulatory calculations

The SAP occupancy assumption is very important to reduce the performance gap as it impacts a large range of factors, including space heating, lighting, domestic hot water and space cooling demands. We therefore recommend further research on the validity of the current formula against occupancy density distributions for different dwelling types and sizes. It may also be justified to look into slightly different formulas across the four nations, dwelling typologies (e.g. house vs flats), and new vs existing dwellings. The work done for the Green Deal occupancy assessment process should feed into this.

Enabling users to specify the occupancy (non-regulatory purposes)

Normalising occupancy is required for Part L and EPC calculations. However, it is proposed that SAP should allow actual occupancy to be inputted in order to improve accuracy for non-regulatory purposes. This would enable those who want to use SAP to evaluate energy use more precisely to be able to do this, which can usefully inform design, construction and retrofit decisions. It would also have a benefit in overheating risk assessments (if these remain linked to SAP).

Table 1b: Assumed number of occupants

If TFA > 13.9 sqm

$$N = 1 + 1.76 \times [1 - \exp(-0.000349 \times (TFA - 13.9)^2)] + 0.0013 \times (TFA - 13.9)$$

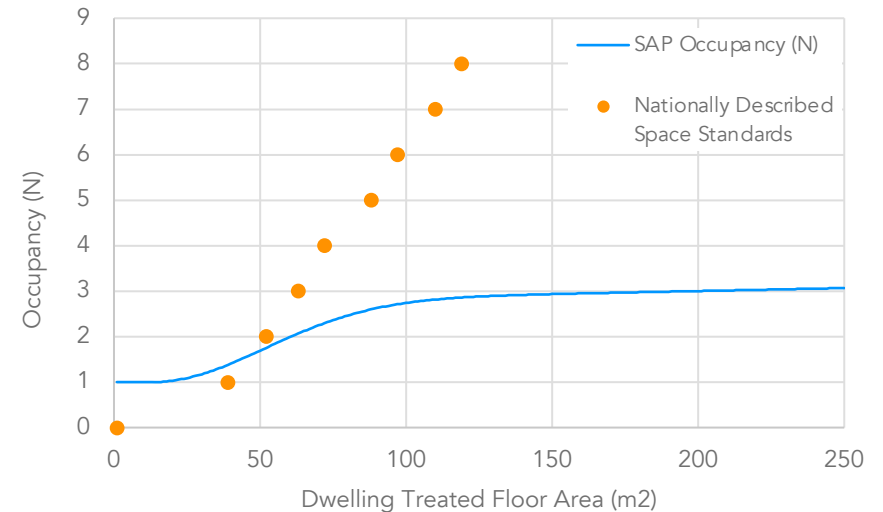

Occupancy formula in SAP (from Table 1b) and comparison between SAP calculated occupancy (N) and the nationally described minimum space standards

Occupancy	
2	2-User determined
Occupancy	
2	1-Standard (only for residential buildings)

In PHPP, the number of occupants is set at a default value for certification purposes but designers can change it if they know the actual number of the future occupants if they want to predict the impact of decisions on future energy use more accurately. This feature is a simple way to enable SAP to be more accurate at predicting energy use. This should be allowed in SAP for uses outside of regulatory compliance.

23 SAP/RdSAP needs to model all heat pump systems accurately to reward efficiency

Heat pumps are one of the main heating technologies that will be used to decarbonise heat and deliver Net Zero Carbon buildings across the UK. SAP/RdSAP 11 must therefore be able to produce reasonable models of performance for the many possible heat pump systems. Low flow temperatures help a heat pump to be efficient, and the new design flow temperature input in SAP 10.1 is very positive. However, additional improvements are recommended.

Improving the calculation of heat pump efficiencies in SAP

The current approach in SAP for heat pumps is two-fold: system efficiencies are either taken from data recorded in the PCDB (if an entry for the chosen product exists) or a conservative default value is assigned. This approach is therefore limited by the breadth of content in the PCDB and its limited ability to take account of dwelling-specific data.

The efficiencies stored in the PCDB are derived from hourly performance calculations (external to SAP) that are based on a number of factors including source temperatures, operating hours, and flow temperatures. Although the initial calculations are thorough and hourly, some inputs (e.g. source temperatures) are standardised and the result is a set of discrete efficiencies for each product depending on a range of plant size ratios. Using the actual plant size ratio SAP applies linear interpolation to derive an efficiency for the modelled system.

We recommend integrating these calculations more thoroughly within SAP, so that inputs would be more specific, and linking them to modelled heating and hot water loads.

Operating regime

Currently heat pump manufacturers can specify a single heating time from a range of options, with operational hours for water heating mirroring those for space heating but continuing all year round. This may not reflect real operation. Thermal stores and the setpoint for DHW storage also have a major impact on heat pump efficiency. In addition, smart controls are now available which synchronise heat pump operation with grid signals, to respond to the need for flexibility.

It is important that SAP 11 models whole heat pump systems to take account of these features.

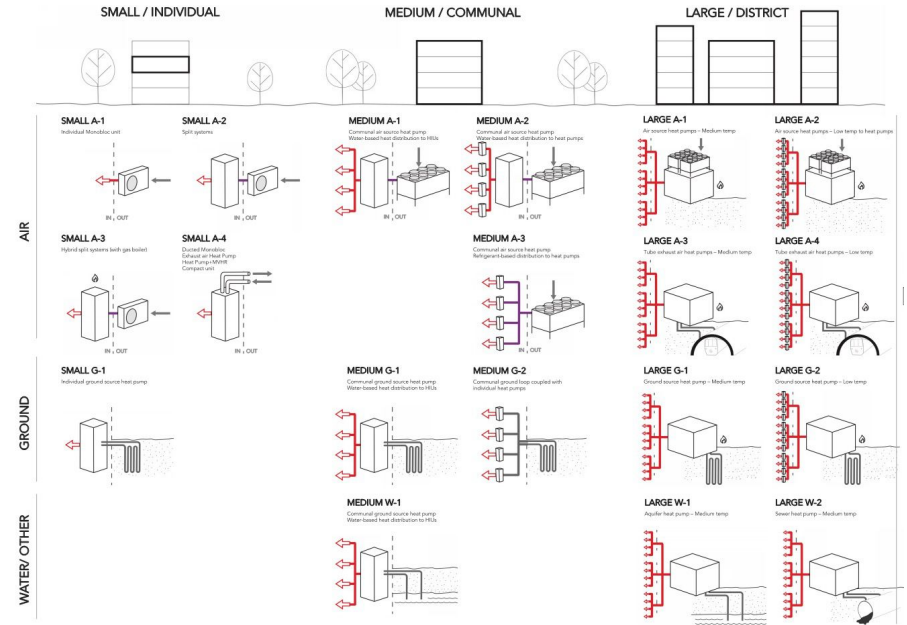

There are many possible combinations of heat pumps to deliver low carbon heat. SAP 11 requires enough flexibility to model these, and perhaps more.

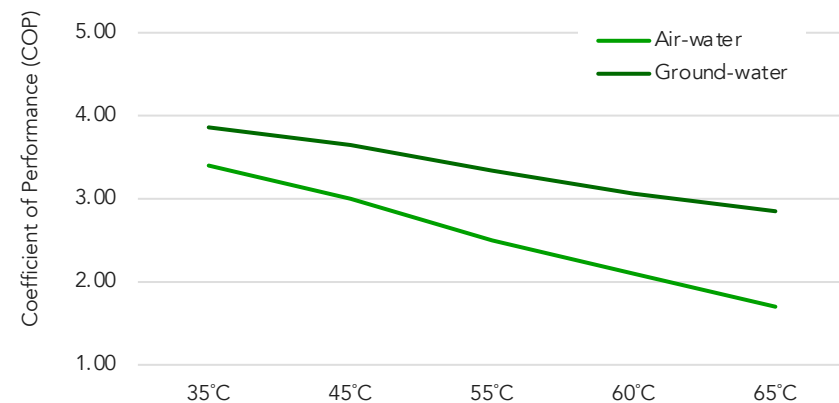

Flow temperature is a very important factor on heat pump efficiency. SAP 10.1 requires user input of the flow temperature, which is a very positive development

24 Heat networks: SAP/RdSAP should evaluate distribution losses more accurately

Evaluating the performance of heat networks properly

There are three key aspects of heat network performance which should be evaluated differently if SAP/RdSAP is to properly assess their impact:

- **Generation mix:** if they are to form part of the solutions to decarbonise heat, heat networks will have to be low carbon or have a firm plan in place to decarbonise. SAP currently only allows the evaluation of the current mix.
- **Fair basis for comparison:** the first draft SAP 10.1 proposed a 'technology factor' for some systems (e.g. gas-fired CHP) which would have allowed them 45% higher carbon emissions from heating. This is no longer proposed, which is welcome. SAP should not be 'manipulated' to suit current heating policy. It must assess the likely performance of technologies and systems as consistently, fairly and accurately as possible to support robust decisions.
- **Distribution losses:** heat 'lost' on the way to the dwelling is very underestimated by SAP 2012, particularly for large schemes. For example for new networks, default losses were estimated around 5-10% of the heating demand when both theoretical calculations and empirical data suggest they are much more significant. SAP 10.1 proposes significantly increased default losses ranging from 20 to 100% but retains a 'proportional assessment' which is not appropriate.

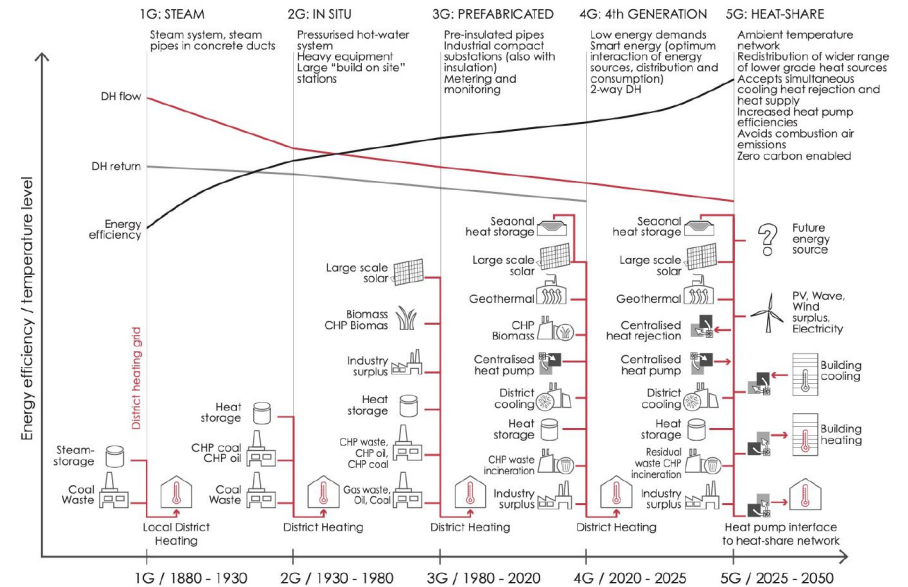

Summary of evolution of heat networks towards lower temperatures and lower carbon sources (Source: Chris Twinn for LETI's Climate Emergency Design Guide)

Generation mix: how can SAP 11 evaluate the future mix?

This is a very complex question: an assessment based on a potential future low carbon generation mix is challenging from a regulatory perspective and raises questions about verification and enforcement of the promised changes, particularly over long timescales. We do not have an answer to this challenging question. However, we think that contractual decarbonisation plans, such as those envisaged in Scotland, could play a role.

We recommend an absolute assessment of distribution losses

Assessing distribution losses in absolute terms (W and kWh) would be much more appropriate than as a proportion of the heat demand. It is both feasible and practical as the measurement and calculations required are relatively straightforward. It would also drive much needed performance improvements, particularly in the design of heat network distribution and heat interface units. We understand a tool from BEIS may be available in the near future to do this.

Heat network supplying an ultra-low energy new flat

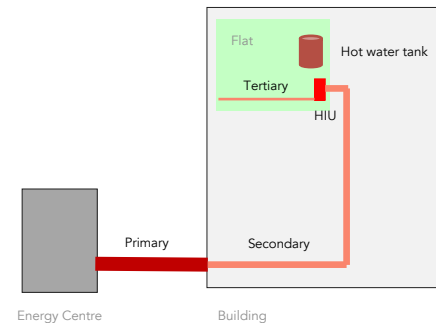

Heat network supplying an inefficient existing flat

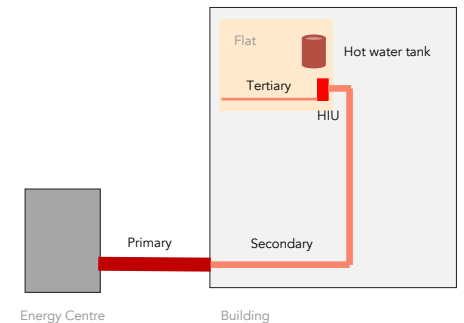

Distribution losses must not be estimated based on the heat demand anymore, as they do not vary proportionally to it. They must be estimated by SAP/RdSAP as absolute heat losses based on the distribution temperatures, the pipe length and the insulation specifications.

25 Solar Photovoltaics require better modelling and a prominent SAP/RdSAP output

The importance of solar photovoltaic technology

Building mounted solar photovoltaic systems are a very important technology that is required to decarbonise electricity generation nationally, produce electricity locally which reduces transmission losses, and deliver Net Zero Carbon buildings. The value to residents of clean affordable electricity at the point of use is also increasing as heat and transportation decarbonise through electrification.

SAP can drive better PV design, which is crucial for Net Zero

As solar technology becomes widespread, it is important to model it more accurately and value technologies or design approaches that increase generation. SAP 11 could drive better practice in PV technology across buildings in the UK.

A first step should be to **review performance data on recent, modern PV systems**, to identify areas of under- and over-performance, and update SAP accordingly. NEED could help with this, but may have limited detail on the types of PV systems. In addition, three key areas of performance that could be included in SAP 11 are:

1 - Module Level Power Electronics

The use of microinverters or DC optimisers can increase energy production by up to 25% by enabling maximum power point tracking for each module. This reduces the impact of shading and soiling; positive power tolerances on some modules can also result in additional energy generation, rather than being written off as 'mismatch' losses as is the case with a central inverter.

2 - Solar module power output warranties

Not all solar panels are equal. The best quality modules on the market today are warranted to generate over 90% of their original rated power after 25 years, with linear degradation in power output. Lower quality modules typically experience higher rates of degradation. Options could be explored for how this could be rewarded in SAP11, including adjustment based on feedback from field studies.

3 - PV technology

Bifacial solar modules collect solar energy from their front and rear face. This can increase energy production by up to 30%, depending on the mounting position and reflectivity of adjacent surfaces. They are set to account for a large part of the global PV market (ITRPV, 2020), though maybe mostly on large-scale installations.

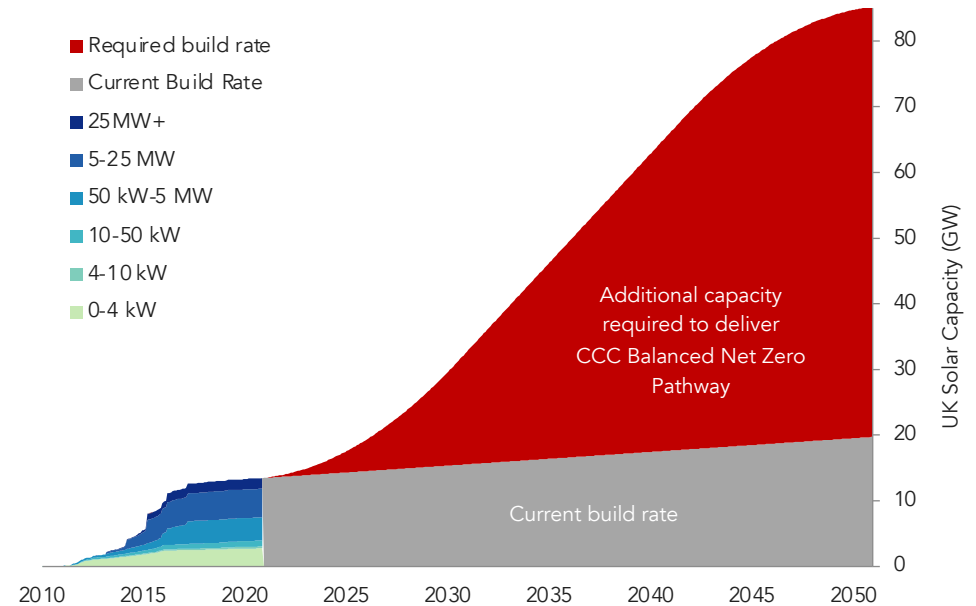

Solar deployment is very important in order to achieve Net Zero Carbon

(Source: generated from BEIS data to Nov 2020 and then projected forward using 2020 build rates compared to the 85GW target in the CCC Balanced Net Zero Pathway from the sixth progress report).



Microinverters or Power Optimisers deliver up to 25% more energy (© Enphase / Solaredge)

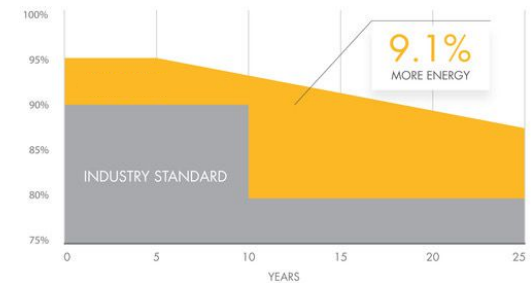

A typical linear power output warranty results in significant additional power generation over the lifetime of a solar panel compared to a lower quality panel (© Sunpower)

Before and after: Mapping out our recommendations (SAP diagrams)

An upgrade on multiple levels

Our 25 key recommendations for SAP/RdSAP 11 tackle both specific aspects of the methodology as well as the overarching strategies and purposes behind it. They look at the power of inputs, both those determined by the user and those embedded in the methodology, the type and depth of the calculations involved, as well as the effectiveness and motive behind the outputs.

To create a truly effective method for delivering Net Zero and evaluating energy consumption across the residential sector, the development of SAP/RdSAP 11 must not only address as many of these individual areas of improvement as possible, but arrive at a single, uncomplicated tool that provides meaningful direction for the building industry.

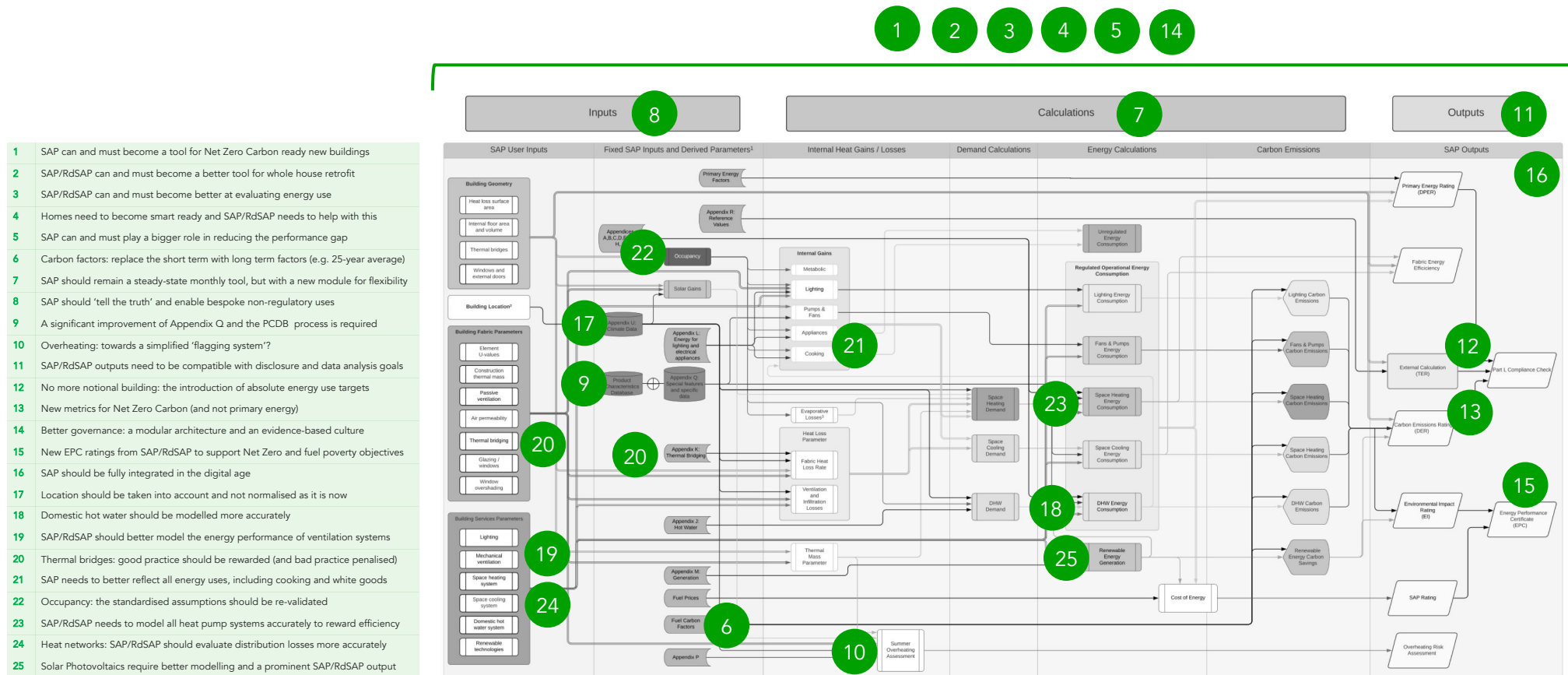

- 1 SAP can and must become a tool for Net Zero Carbon ready new buildings
- 2 SAP/RdSAP can and must become a better tool for whole house retrofit
- 3 SAP/RdSAP can and must become better at evaluating energy use
- 4 Homes need to become smart ready and SAP/RdSAP needs to help with this
- 5 SAP can and must play a bigger role in reducing the performance gap
- 6 Carbon factors: replace the short term with long term factors (e.g. 25-year average)
- 7 SAP should remain a steady-state monthly tool, but with a new module for flexibility
- 8 SAP should 'tell the truth' and enable bespoke non-regulatory uses
- 9 A significant improvement of Appendix Q and the PCDB process is required
- 10 Overheating: towards a simplified 'flagging system'?
- 11 SAP/RdSAP outputs need to be compatible with disclosure and data analysis goals
- 12 No more notional building: the introduction of absolute energy use targets
- 13 New metrics for Net Zero Carbon (and not primary energy)
- 14 Better governance: a modular architecture and an evidence-based culture
- 15 New EPC ratings from SAP/RdSAP to support Net Zero and fuel poverty objectives
- 16 SAP should be fully integrated in the digital age
- 17 Location should be taken into account and not normalised as it is now
- 18 Domestic hot water should be modelled more accurately
- 19 SAP/RdSAP should better model the energy performance of ventilation systems
- 20 Thermal bridges: good practice should be rewarded (and bad practice penalised)
- 21 SAP needs to better reflect all energy uses, including cooking and white goods
- 22 Occupancy: the standardised assumptions should be re-validated
- 23 SAP/RdSAP needs to model all heat pump systems accurately to reward efficiency
- 24 Heat networks: SAP/RdSAP should evaluate distribution losses more accurately
- 25 Solar Photovoltaics require better modelling and a prominent SAP/RdSAP output

The result: a better SAP towards Net Zero

Priority policy objectives	SAP/RdSAP 11 potential performance against objectives	
Net Zero Carbon by 2050	✓	<p>Significant improvements</p> <ul style="list-style-type: none"> The redefinition of SAP's main purpose as a tool to assist the delivery of Net Zero Carbon ready new buildings would ensure alignment between the strategic objective, the process of designing and constructing new homes and the SAP methodology. SAP and RdSAP would better support a whole house retrofit approach and indicate what improvements to energy and carbon performance are possible, which means opportunities could be identified, accelerating improvements to and decarbonisation of the existing stock. The SAP outputs would be used against an absolute target, consistent with the nature of the Net Zero Carbon target which is absolute. SAP would consider regulated and unregulated energy uses, i.e. total energy use. This total energy use metric can be checked post-completion and therefore it would create a positive feedback loop, increasing clarity for consumers and enabling government to monitor policy effectiveness, track decarbonisation and carry out forecasting to achieve Net Zero. SAP would use medium-term carbon factors (e.g. 25-year averages) which would reflect forward-looking scenarios for the electricity grid, better representing the average carbon emission of a home over the next 25 years, rather than its immediate emissions.
<p>Improving energy efficiency and reducing demand</p> <p>New and existing homes</p>	✓	<p>Significant improvements</p> <ul style="list-style-type: none"> The key metric in SAP/RdSAP would be energy use, the best indicator of energy efficiency. The evaluation of energy use would be more accurate by having an assessment based on the actual location of the dwelling (e.g. regional). Additional accuracy would be possible by enabling users to adjust inputs for non-regulatory purposes e.g. occupancy, heating set points. SAP would continue to include a fabric and ventilation efficiency metric to express thermal demand related to fabric performance. This metric may be a Space Heating demand metric or the Heat Transfer Coefficient metric. The inclusion of an output related to peak demand and/or demand management (e.g. Smart Readiness Indicator, energy storage capability, peak demand) would allow SAP to value strategies aimed at reducing peak demand and at shifting demand for system flexibility. These would in turn support policies for the electricity grid to become lower carbon at a smaller cost. Having energy use as a key metric, and better evaluating it, would also improve SAP/RdSAP's ability to support fuel poverty policies where it best can: reducing energy use through building performance.
Heat decarbonisation	✓	<p>Significant improvements</p> <ul style="list-style-type: none"> SAP would use medium-term carbon factors (e.g. 25-year averages). This would support policies to move away from fossil fuels. Key technologies for the decarbonisation of heat (e.g. heat pumps) would be better modelled. The assessment of hot water demand would be more detailed, reflecting its growing relative proportion of total heat demand in new buildings. SAP would no longer use a notional building, helping to accelerate the transition away from fossil fuel heating. SAP would not include "fudge factors" intended to support particular systems or technologies; it would assess low-carbon heat options on a fair basis and support a faster transition away from fossil fuel heating.

5.0

Feedback from SAP users and the wider industry

We were keen to understand the opinions of SAP users and the industry as a whole so we have run an online survey in November and December 2020.

The 220+ responses highlight areas of consensus and divergence, which are summarised in this section.

The individual comments and suggestions are also extremely valuable on their own. They have been anonymised and will be provided to BEIS alongside this report.

Our survey of SAP/RdSAP users

Aims for the survey

This project sought to canvass the opinion of the people who interact with SAP/RdSAP on a day to day basis, to understand fundamental issues and better understand from industry how SAP/RdSAP is used and what functions it needs to perform. With this in mind the survey aimed to understand:

- What are the issues in the current version of SAP that need to be addressed?
- How could/should SAP change and evolve to support better buildings?

Topics up for discussion

The survey was divided in two parts to allow us to ask direct questions on SAP/RdSAP and future direction, as well as allowing the survey respondents to submit their own comments on issues with SAP/RdSAP. The questions covered:

- Outputs and metrics of performance
- Target setting
- Whole house retrofit
- SAP as a design tool
- Carbon factors
- Overheating
- Demand management
- Low or zero carbon technologies
- Performance gap

Shared views and differing opinion

The survey was shared widely through this project team and other organisations, including the CIBSE newsletter which is issued to over 20,000 recipients from a wide range of backgrounds. Survey participants came from varied disciplines and brought various levels of understanding and experience with SAP/RdSAP – while energy/sustainability consultants were the largest group of respondents, energy assessors were second, which indicates a good representation of SAP/RdSAP users focused on compliance and EPC functions. The questions were wide ranging and some test new ideas, often with pros and cons. This is shown in the results with some topics reaching consensus opinion, whereas others are much more divided.

A summary of the results for each question as well as the full individual response is presented in Appendix H.

Response rate

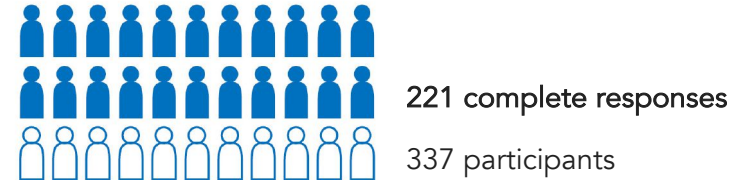

Participants role	No. of participants
Energy/sustainability consultant	103
Energy assessor	30
Building services engineer	27
Manufacturer	19
Architect	13
Accreditation body	5
Developer	5
Software company	5
Academia	4
Contractor	4
Local authority - planning	2
Local authority - other	2
Housing association	2
Other - anonymous	106

Time taken

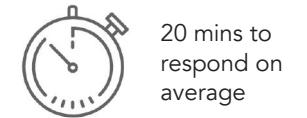

Comments

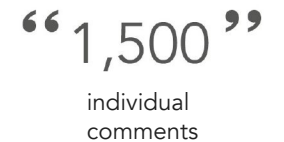

300 comments on issues with current SAP/RdSAP

** While not specifically identified as a category of respondents, housebuilders are expected to be represented under a number of the above categories, including contractors, developers, and the various other disciplines which may operate within a housebuilding organisation (e.g. in-house energy assessor).*

Summary of feedback from SAP users | Shared views

The survey addressed some core aspects of SAP - many of the questions regarding these points were met with a majority opinion and in general an undeniable support for change.

Target setting



“ An absolute figure ensures the focus remains on a directly measurable aspect, enabling simple reporting of future improvements. ”

68% believe the notional dwelling is not a useful measure and that an absolute target should be set instead

Key metrics

85%

think energy use should be a key metric

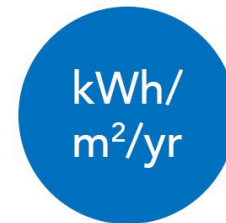

Use SAP as a design tool

85%

would like to see the SAP methodology also used for non-regulatory purposes, with more detailed inputs, allowing for a more accurate assessment of building performance

“ Is there any justification for not doing this? ”

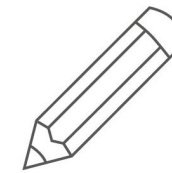

“ This would help to communicate the difference between SAP as a regulatory tool and as a potential model for individual dwelling performance. ”

Use SAP for retrofit

It is clear that respondents think SAP should be a tool to better inform retrofit.

80-87% thought that to be a sufficient retrofit tool SAP should:

- Evaluate possible deep retrofit 'end goals'
- Introduce prompts to encourage 'whole-house thinking'
- Take better account of airtightness and other associated improvements

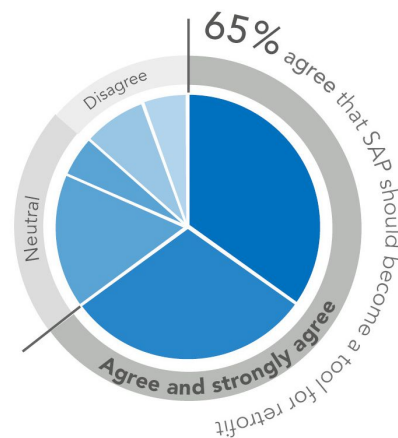

Those who did not, tended to think that SAP was not a detailed enough calculation methodology at the moment.

Encourage demand management

80%

agree, with over half of these strongly agreeing.

75-80% agreed that to do this SAP should account for:

- Peak electrical demand
- Thermal storage
- Smart technologies
- Electrical storage

Use actual dwelling location

90%

agree that SAP should be based on a dwelling's actual location, rather than a normalised one



Summary of feedback from SAP users | Further detail and differing opinions

The survey showed that respondents expected building performance to be rated by various metrics, but in order to do so, this would need more accuracy in the assessment methodology.

Hierarchy of metrics

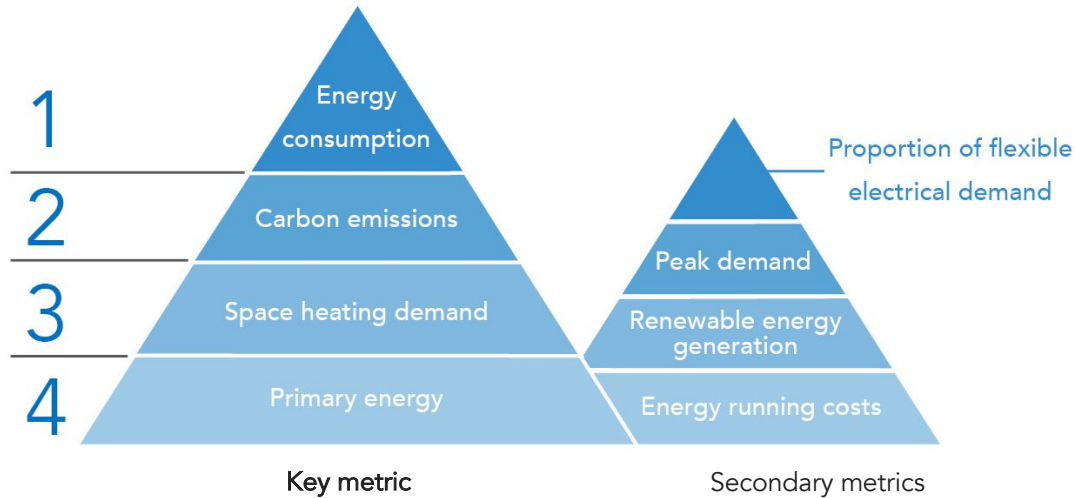

Other questions showed respondents were less clear on how SAP should develop, as many options came with their own drawbacks.

No clear consensus on carbon factors

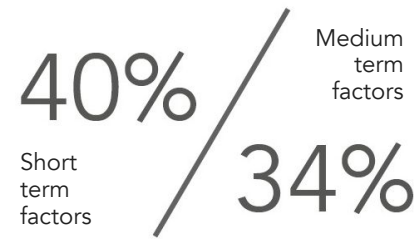

- “ I would be concerned that longer term factors might allow future decarbonisation to soften what is required now. ”
- “ For building regulations compliance, a longer-term approach would better assess the lifetime carbon emissions of running the building. ”
- “ For EPCs, a shorter term assessment is probably more appropriate, given that this is supposed to represent the current performance of the building. ”

93 people provided a detailed response to this question highlighting that people were reluctant to select one particular approach.

Where SAP needs improvement

75% Agree that SAP needs to be more accurate in the assessment of:

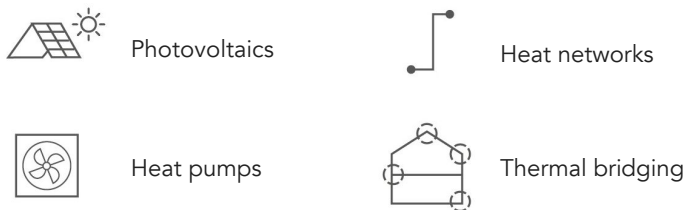

75% also agreed that SAP should include the assessment of unregulated energy.

Dynamic or steady-state modelling?

There was a slight bias for steady-state modelling but with more accuracy than currently. Comments suggested that most do not want SAP to become so complex that it is unintelligible.

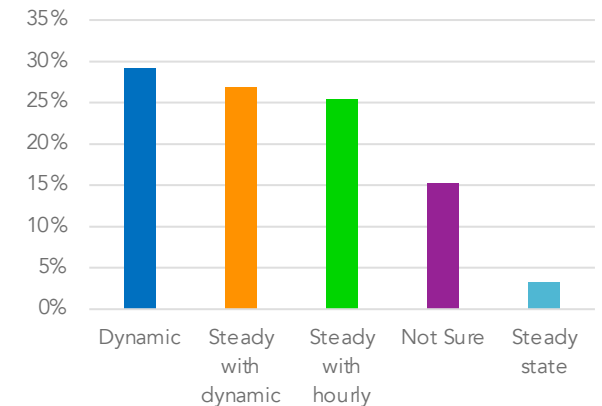



Conclusion and next steps

The aim of this report was to summarise which issues should be addressed by SAP/RdSAP 11 and to provide a set of clear recommendations for the team who will work on it.





















































In the process of developing these recommendations, we have been able to identify areas where there is a strong consensus and themes where opinions are more split.

We have also been able to assess the level of complexity associated with delivering this recommendation. The adjacent table seeks to summarise this.

Based on our engagement with experts and on the online survey, recommendations with three ticks    have a particularly high level of support in the industry.

Recommendations with three “plus” +++ are more complex and will require time to develop and incorporate satisfactorily in SAP 11:

- The role of SAP and RdSAP to deliver whole house retrofit of existing homes
- How SAP can help homes to become smart ready i.e. how it can assess peak demand reduction and shifting to coincide with renewable energy generation) and the development of the associated new SAP module providing more functionality and flexibility
- A review of the role and the process of Appendix Q and the PCDB.

		Level of consensus	Level of complexity
1	SAP can and must become a tool for Net Zero Carbon ready new buildings	  	+
2	SAP/RdSAP can and must become a better tool for whole house retrofit	 	+++
3	SAP/RdSAP should become better at evaluating energy use	  	++
4	Homes need to become smart ready and SAP/RdSAP needs to help with this	 	+++
5	SAP can and should play a bigger role in reducing the performance gap	 	++
6	Carbon factors: replace the short term by long term factors (e.g. 25-year average)	 	+
7	SAP should remain a steady-state monthly tool, but with a new module for flexibility		+++
8	SAP should ‘tell the truth’ and enable bespoke non-regulatory uses	  	+
9	A significant improvement of Appendix Q and the PCDB process is required	 	+++
10	Overheating: towards a simplified ‘flagging system’?		++
11	SAP/RdSAP outputs need to be compatible with disclosure and data analysis goals	 	+
12	No more notional building: the introduction of absolute energy use targets	  	+ new / ++ existing
13	New metrics for Net Zero Carbon (and not primary energy)	 	+
14	Better governance: a modular architecture and an evidence-based culture	 	++
15	New EPC ratings from SAP/RdSAP to support Net Zero and fuel poverty objectives	  	++
16	SAP should be fully integrated in the digital age	  	++
17	Location should be taken into account and not normalised as it is now	  	+
18	Domestic hot water should be modelled more accurately		++
19	SAP should better model the energy performance of ventilation systems	 	+
20	Thermal bridges: good practice should be rewarded (and bad practice penalised)	 	++
21	SAP needs to better reflect all energy uses, including cooking and white goods	 	++
22	Occupancy: the standardised assumptions should be re-validated		+
23	SAP needs to model all heat pump systems accurately to reward the most efficient	 	++
24	Heat networks: SAP should evaluate distribution losses more accurately		++
25	Solar Photovoltaics: better modelling and a prominent SAP output are required	 	+

Next steps | Precedents from the review of domestic energy modelling methodologies across the World

Domestic energy models were reviewed from Europe and across the world, this page provides a summary of our findings and how they can help to inform the development of some key aspects of SAP/RdSAP.





40+ ecosystems, modelling methods and tools reviewed

 10 European countries	 8 Countries/ states outside of Europe
 8 Voluntary standards for existing building	 9 Voluntary standards that focus mainly on new buildings
 10 Regulatory standards	 15 Simulation tools

Best practice ecosystems

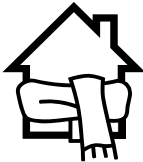
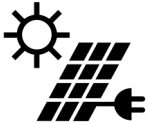
- A clear long term target definition of zero carbon
- Stepped targets – clarity on future targets that improve over time
- Various routes to compliance
- Building labelling and disclosure
- Best-in-class building fabric
- Scrutiny of thermal bridging and details
- Clear differentiation between design methods and in-use reporting
- Enhanced energy modeller qualifications
- Inclusion of embodied carbon, refrigerant leakage and resilience metrics

Of the reviewed regulatory and voluntary standards:

 12 have a total energy use (EUI) metric	 15 have a space heating metric	 13 have an on-site renewables metric
 18 have an absolute target	 12 Methods encourage fabric first standards and are steady state	 11 require data disclosure

Best practice modelling methodologies

- Same tool used for regulation and voluntary standards
- Methods used for both regulatory compliance and predictive modelling
- Evolution of metrics and targets over time
- Reporting and reducing peak energy use
- Holistic design taking account of energy and overheating
- Clear reporting templates
- Different methodologies depending on the scale of the development

Best practice tools

- Simple user interface
- Transparency of simulation tool

6.0

Anatomy of SAP and issue log

This section summarises our work on:

- the Issues log for SAP/RdSAP
- the diagrams representing how SAP and RdSAP work.

The SAP and RdSAP issues log

About the SAP/RdSAP issues log

We have put together a comprehensive 'SAP/RdSAP issues log' highlighting missed opportunities. This spreadsheet captures the detail of our workings across a list of every input, calculation and output of SAP.

The first part of the spreadsheet focuses on the troubleshooting and differences between SAP 2012, SAP 10 and RdSAP. We have used these columns to sift out the issues, categorising them to understand whether inputs are 'detailed entries', 'simplified metrics' or if the issue is 'not taken into account'. The traffic light system gives us the first indication of where detail might be lacking in SAP.

The second half uses sensitivity analysis to appraise whether the issue:

- Has an impact on the performance of the building
- Whether it prevents SAP being used as a design tool
- Whether it adds unnecessary complexity.

It then allows us to determine an initial outcome and potential improvement options.

This issues log is designed to be a working document that can be edited and updated as SAP continues to evolve.

Smaller issues

The detailed analysis has enabled us to pinpoint large and small issues and their potential causes. A number of the larger issues have been included as part of the 25 key recommendations. However, some of the smaller issues that would benefit from a review when SAP is updated include:

- A review of adjacent elements where shelter factors are used to assume a lower heat loss to corridors and garages. The application of adjacent elements is inconsistent, focuses on walls only and does not take into account the thermal line of the building.
- The role of the thermal performance of party walls. Could this be simplified to relate to the thermal line of the building rather than the dwelling.
- The need for the input of internal walls for thermal mass parameters only.
- The potential use of alternative airtightness metrics based on a whole building approach.
- A review of the way cooling systems are inputted and the assumptions made by SAP as to when they are used by occupants.

SAP and RdSAP Issues Log				
Rev D 25.01.2021				
* We expect most comments also apply to RdSAP. Unless the issue is not included in RdSAP.				
		SAP 2012*		DRAFT SAP 10 (only where different from 2012)*
Factors contributing to energy use		Missed opportunity with 2012 calc.	Comments	Missed opportunity with SAP10 calc.
Inputs				
Thermal mass	Thermal mass parameter	Indicative low/med/high - often missed by assessors, partly because it could be unknown, but also used to improve results. Affects results of EER, EPES and overheating. Calculated (enter kappa value into dwelling elements) or user value (for value for whole home). Suspect this is rarely used. Kappa value gets automatically entered into external walls, floors and roofs when construction type is selected.	Simplified metric used Accurate or detailed entry possible	This value appears insignificant in SAP but is relatively significant. The other gains measured because indicative values can be entered.
Location	Region Dwelling address (climate data - appendix U)	The region could be more intelligent based on postcode, there are 12 regions. Energy use and costs on EPC use regional data. Climate data uses average month temperatures, wind speed and solar radiation. This is based on UK average weather from 21 sea weather regions based on postcodes. This also sets the latitude and height above mean sea level. The dwelling address forms the selection of the climate data for PV, overheating, EPC costs and wind. Future climate not taken into account. The climate data is not used for energy calculations.	Simplified metric used Simplified metric used	By not accounting for the geographical location of the dwelling the accuracy of the energy calculation is demonstrably impacted. The modelled climate conditions can be significantly different from the actual conditions.
Terrain	Dense urban, low rise urban/suburban, rural	This appears to be used for wind speed correction factors for micro wind turbines.	Simplified metric used	
Orientation		The solar gains from the orientation are taken into account through the window orientations and sizes etc. But optimization of the general orientation through solar gains is not assessed due to use of target/notional dwelling of same orientation.	Simplified metric used	The notional building affects the usefulness of the metrics.
Smoke control area		Not sure of the relevance of including this in SAP, is it compared with systems and fuels selected? Does it prevent certain system of fuel selection?	Simplified metric used	

Screenshot of part of the SAP/RdSAP issues log – showing inputs for SAP 2012, SAP 10 and RdSAP and troubleshooting the differences.

Sensitivity			Initial outcome		Improvement options				Overall finding	
Does the issue have an impact on the performance of the building?	Does the issue prevent SAP being used as a design tool?	Does the issue add unnecessary complexity?	Improvement advisable?	Comments	Could the issue be easily fixed?	Does the issue have a negative impact on the capital cost of the building?	Would SAP work just as well without this feature/issue at all?	Does the issue relate to the use of a notional building?	Possible improvements from other methods?	Should this be fixed?
Yes	Maybe	No	Improvement advisable	Minor	Unknown	Maybe	No	No		
Yes	Maybe	Unknown	Undecided/should this be improved?	Relates to the generic thermal mass parameter above	Unknown	Maybe	No	No		
Yes	Yes	No	Improvement advisable							
Yes	Yes	No	Improvement strongly recommended	SAP and RdSAP 11 should factor in local geographical climate conditions, including when determining energy demands for Part L and EPC's.	Yes	No	No	No		Yes - one of the 25 key recommendations in SAP 11 report
			Keep SAP 10 treatment							
Yes	Yes	No	Improvement strongly	Issue with notional	Maybe	No	No	Yes		Yes - one of the 25 key recommendation

Screenshot of part of the SAP/RdSAP issues log – showing sensitivity analysis and proposed outcomes for the issues found.

The anatomy of SAP and RdSAP: diagrams

Visualising the different components of SAP and RdSAP

It may appear to be a detail, but we think that the absence of a diagram simplifying how SAP and RdSAP work represents a barrier for a better understanding of what could/should be improved.

For this reason, we have produced a number of diagrams as part of this scoping project:

1. a SAP 2012 diagram
2. a SAP 10 diagram
3. a simplified SAP 10 diagram
4. a RdSAP diagram

Using these diagrams to understand differences and assist development

We have used these diagrams to visualise differences, i.e.

- changes between SAP 2012 and SAP 10
- differences between SAP and RdSAP.

There is also potential to use these diagrams to visualise where changes are required or also where underlying evidence is weaker.

Developing a more open development culture around SAP

We recommend that these diagrams are further improved and refined. They could contribute towards a more open development culture around SAP with the update of different component parts being displayed more clearly or call for evidence for other elements.

Ideally they should be available online, with users able to navigate the diagrams and modules at various levels of detail.

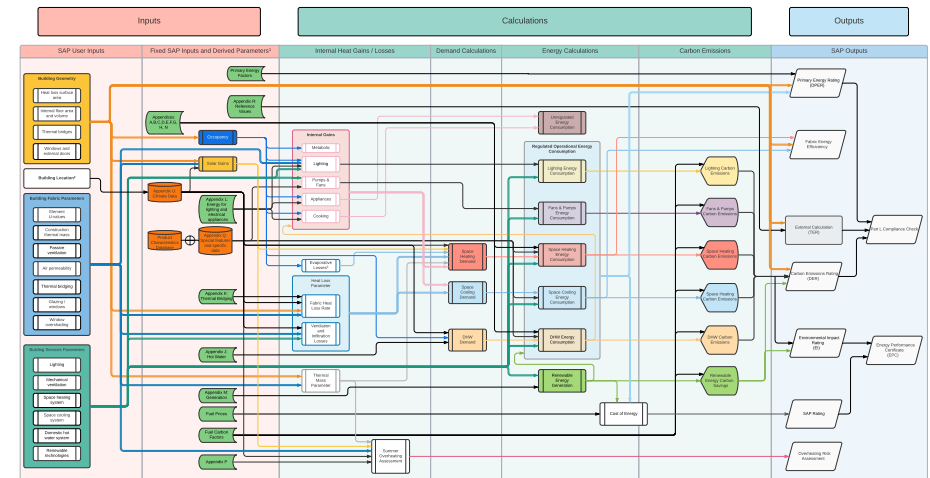

SAP 10 diagram developed as part of this SAP 11 scoping project

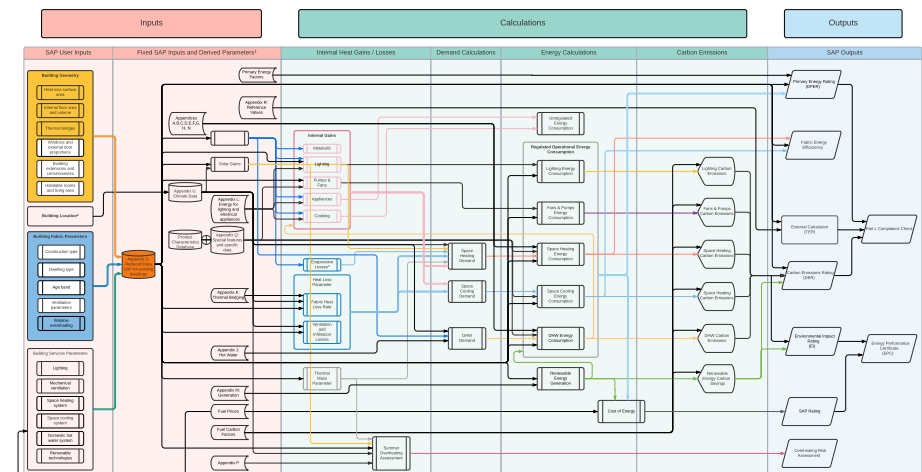

RdSAP diagram developed as part of this RdSAP 11 scoping project

The anatomy of SAP and RdSAP | Simplified SAP 10 diagram

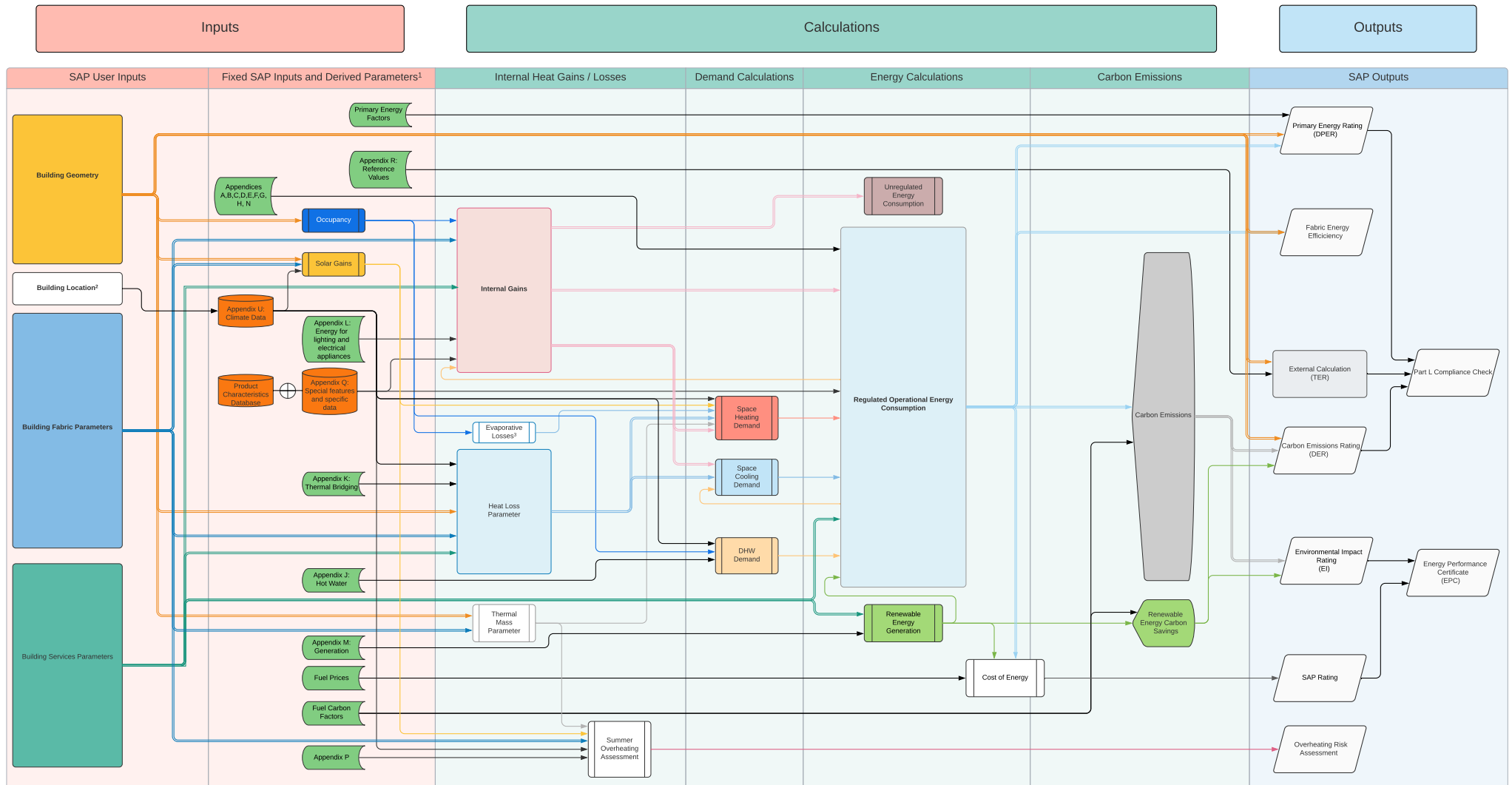

Footnotes
 1 SAP has further fixed inputs that are implicit to its various calculations, this column highlights key inputs and appendices.
 2 Location input has an impact on overheating and PV energy generation. Calculations for compliance and ratings are based on UK average weather.
 3 Includes losses associated with the heating of incoming cold water and evaporation.

A simplified representation of the SAP10 process depicting the main data flows and calculations.

The anatomy of SAP and RdSAP | SAP 10 diagram

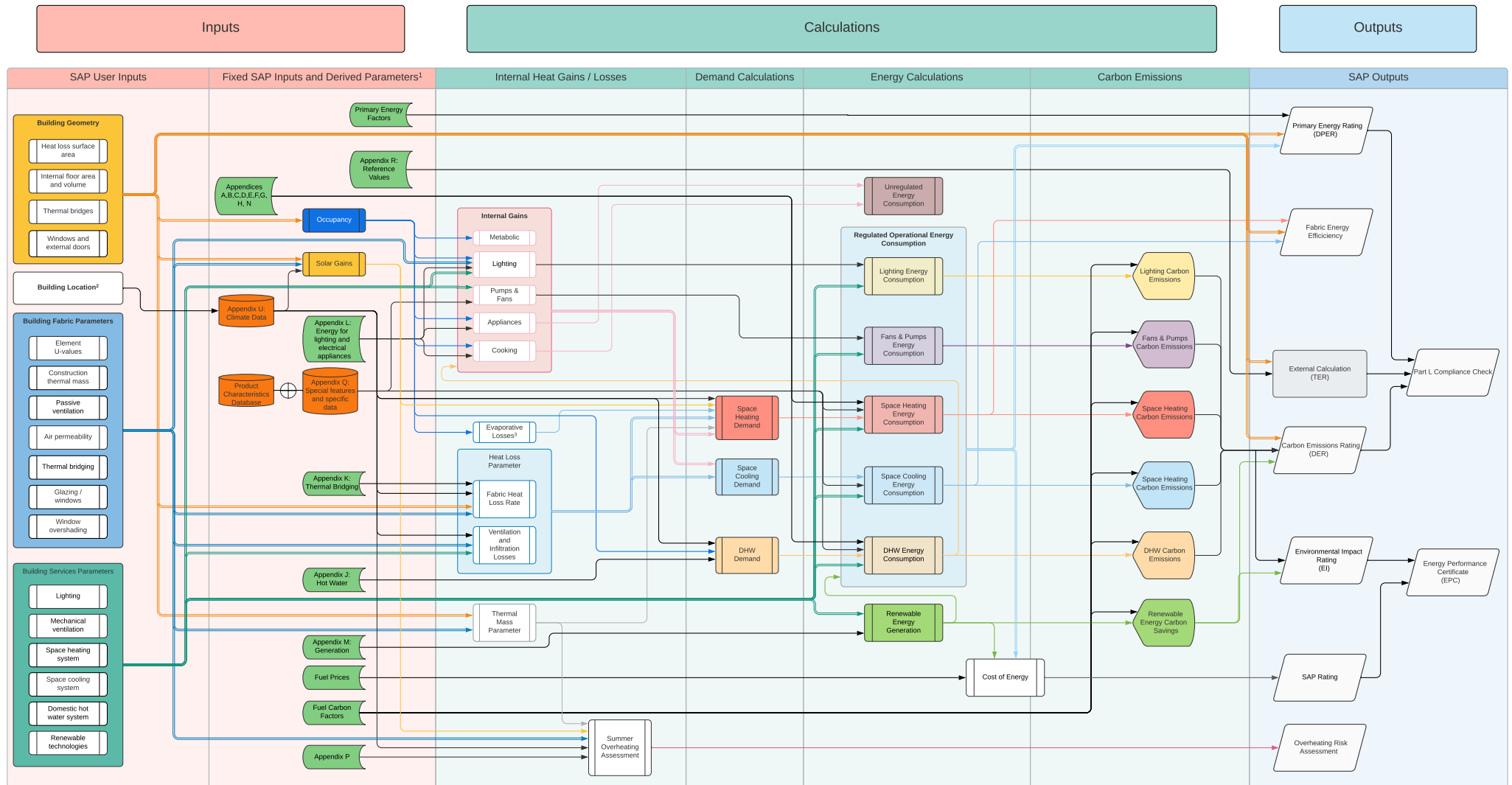

Footnotes
¹ SAP10 has further fixed inputs that are implicit to its various calculations, this column highlights key inputs and appendices.
² Location input has an impact on overheating and PV energy generation. Calculations for compliance and ratings are based on UK average weather.
³ Includes losses associated with the heating of incoming cold water and evaporation.

Diagrammatic representation of the SAP10 process to help map and understand the proposed SAP methodology. Arrows indicate the flow of data from user determined and fixed inputs to calculation boxes, where SAP software performs the process calculations, to the designed outputs.

The anatomy of SAP and RdSAP | SAP 2012 diagram

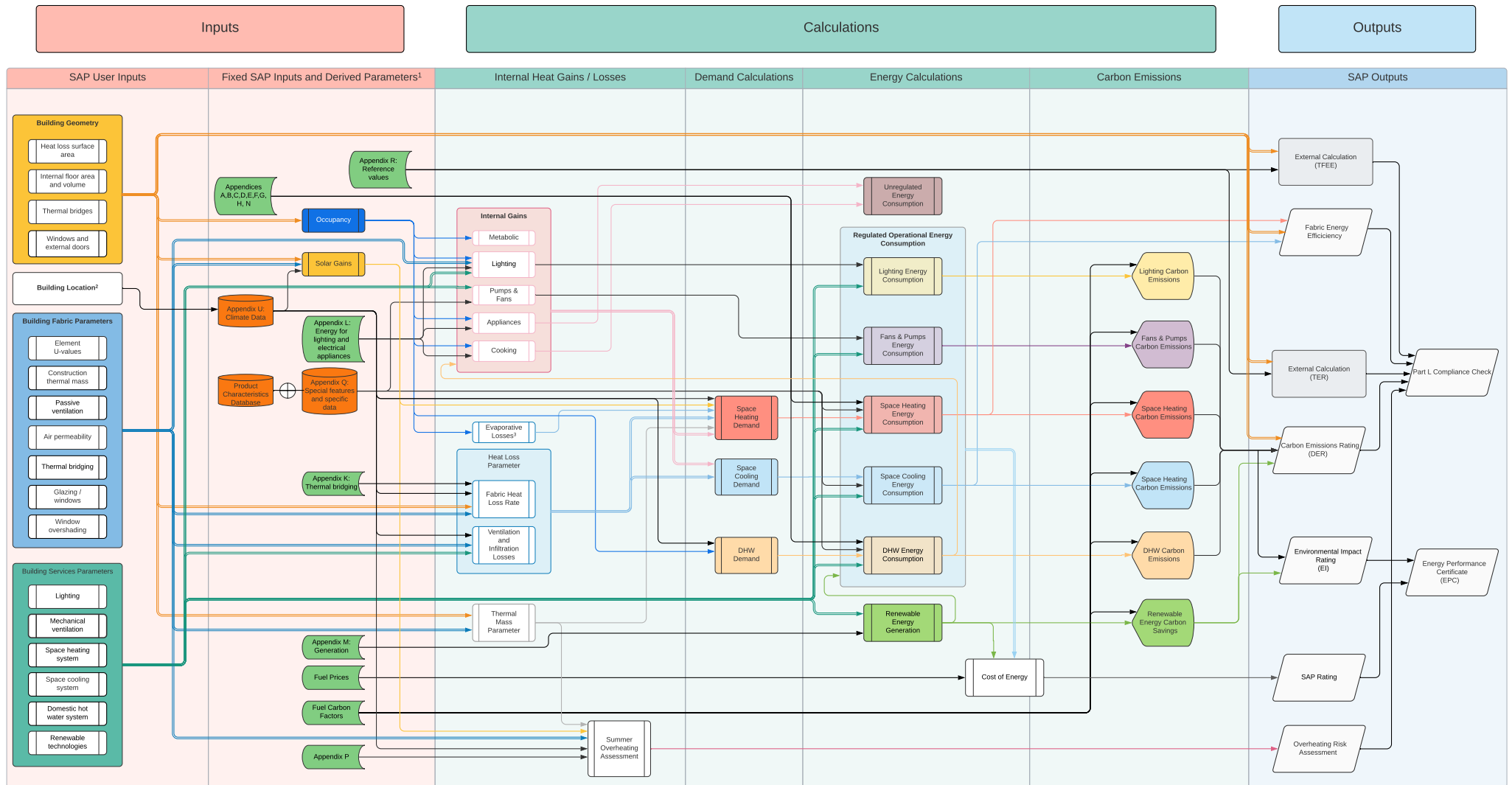

Footnotes
¹ SAP 2012 has further fixed inputs that are implicit to its various calculations, this column highlights key inputs and appendices.
² Location input has an impact on overheating and PV energy generation. Calculations for compliance and ratings are based on UK average weather.
³ Includes losses associated with the heating of incoming cold water and evaporation.

Diagrammatic representation of the SAP 2012 process. At the time of writing SAP 2012 is the current methodology to be used for compliance with Building Regulations.

Arrows indicate the flow of data from user determined and fixed inputs to calculation boxes, where SAP software performs the process calculations, to the designed outputs.

The anatomy of SAP and RdSAP | What has changed between SAP 2012 and SAP 10?

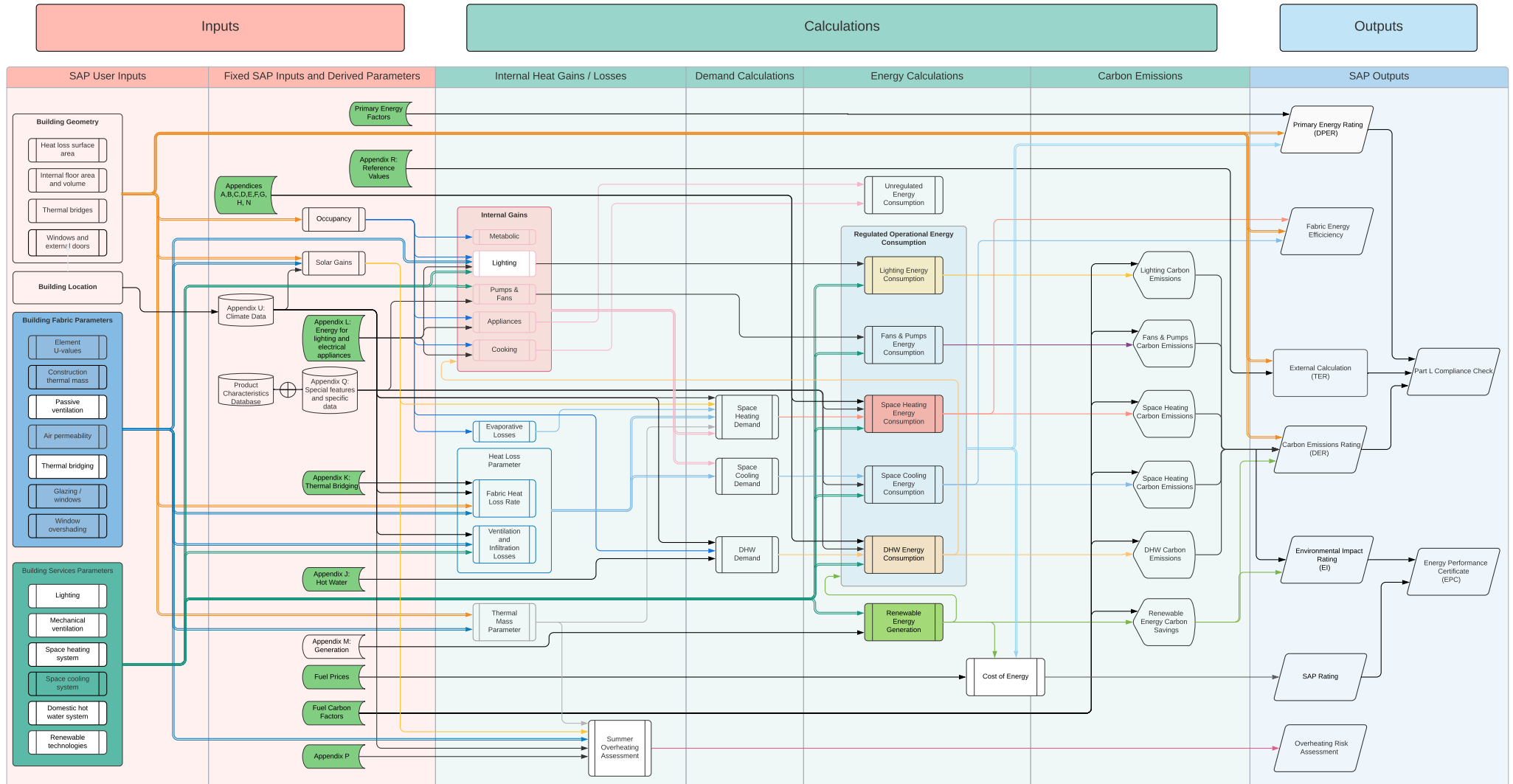

Following a 2017 consultation on the standard assessment procedure SAP 10 was published. The 'SAP – what has changed?' diagram highlights the main areas of change proposed for the SAP methodology. 'Greyed out' shapes represent parts of the process that are believed to have mostly remained the same.

The anatomy of SAP and RdSAP | RdSAP

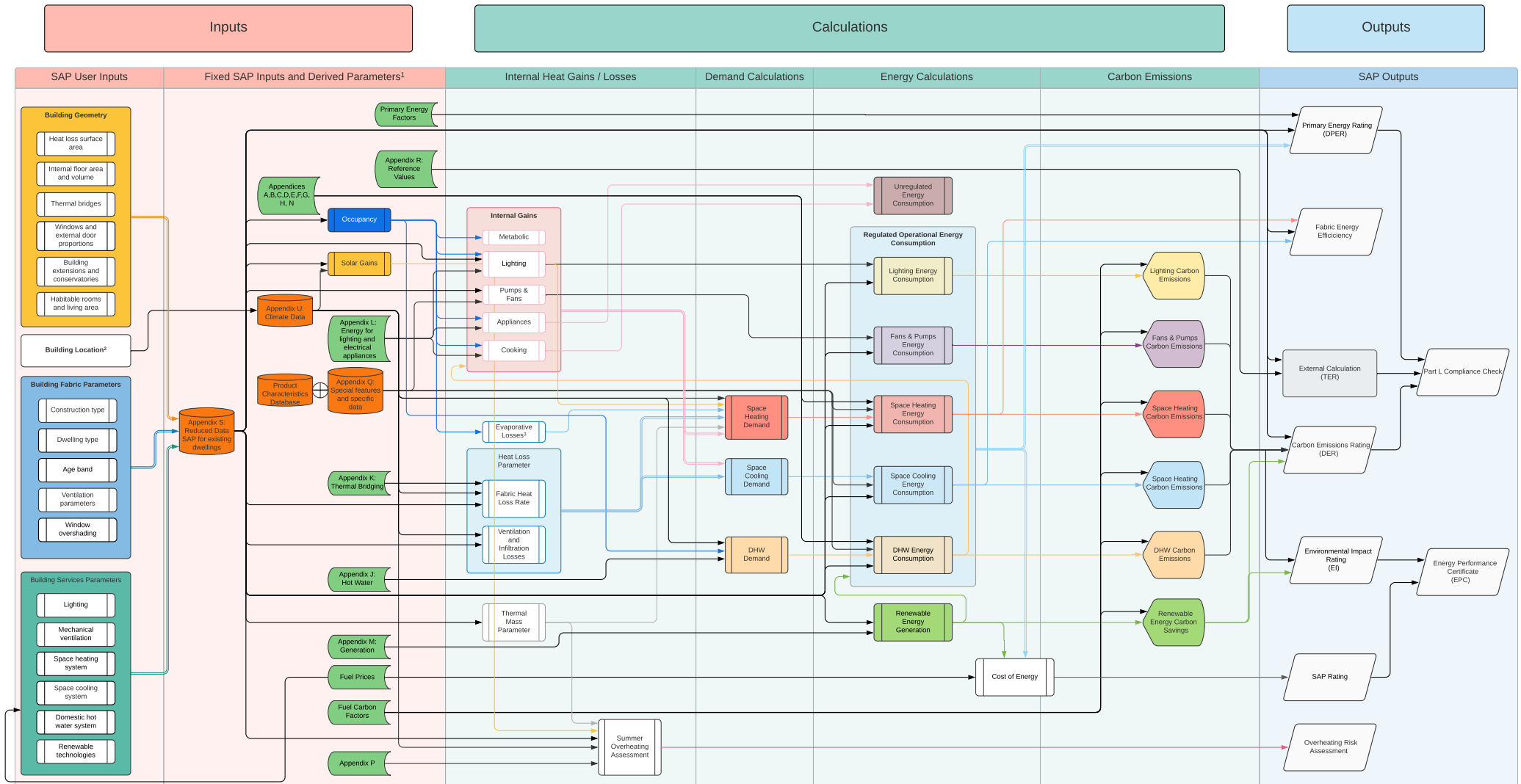

Footnotes
 1 RdSAP10 has further fixed inputs that are implicit to its various calculations, this column highlights key inputs and appendices.
 2 Location input has an impact on overheating and PV energy generation. Calculations for compliance and ratings are based on UK average weather.
 3 Includes losses associated with the heating of incoming cold water and evaporation.

Diagrammatic representation of the SAP10 process to help map and understand the proposed SAP methodology. RdSAP 10 is likely to be adopted when the next version of Building Regulations are published. Arrows indicate the flow of data from user determined and fixed inputs to calculation boxes, where SAP software performs the process calculations, to the designed outputs.

The anatomy of SAP and RdSAP | What is different between SAP and RdSAP?

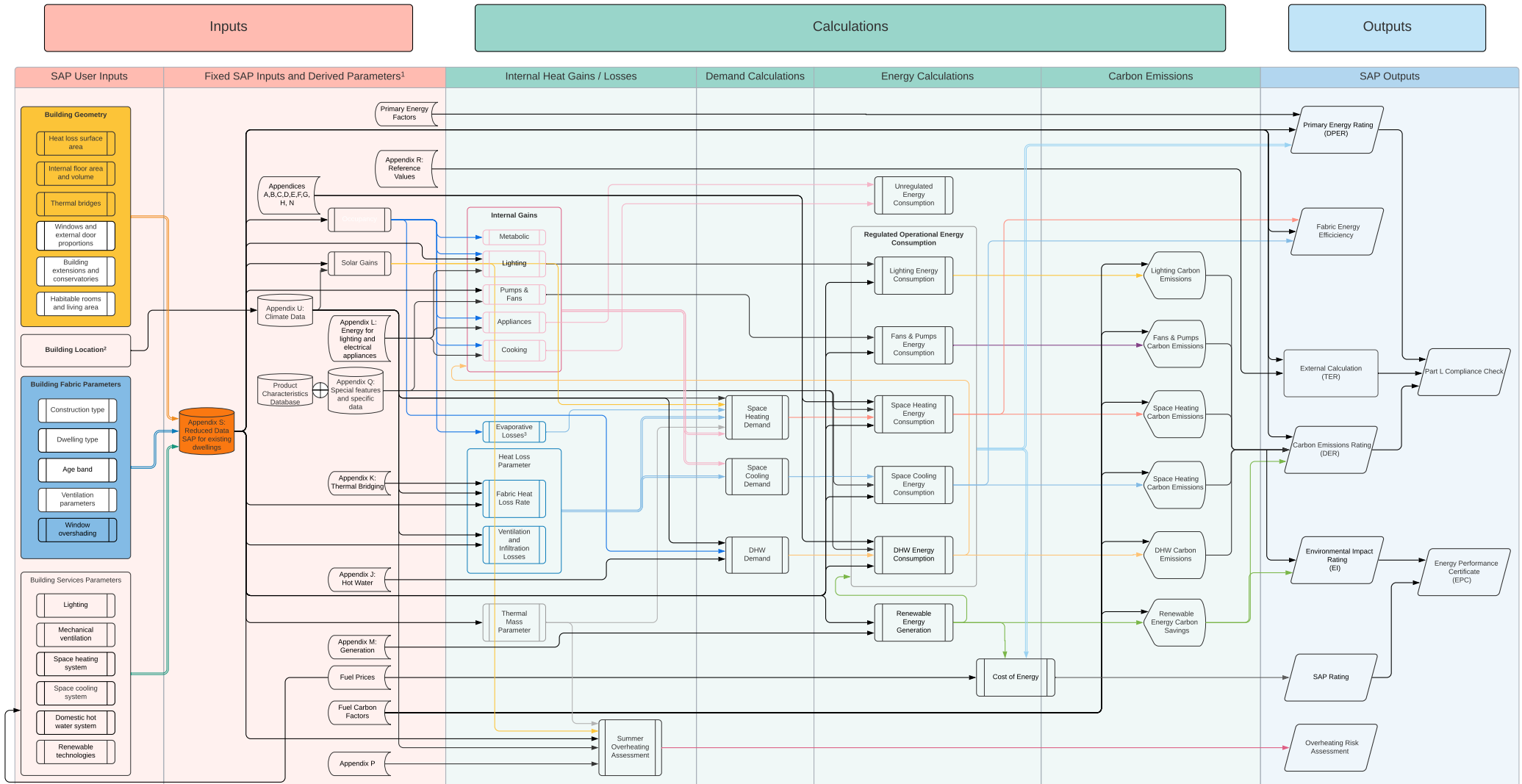

Footnotes
 1 RdSAP10 has further fixed inputs that are implicit to its various calculations, this column highlights key inputs and appendices.
 2 Location input has an impact on overheating and PV energy generation. Calculations for compliance and ratings are based on UK average weather.
 3 Includes losses associated with the heating of incoming cold water and evaporation.

The 'RdSAP – what is different?' diagram highlights the main differences between the SAP 10 and RdSAP 10 methodologies. 'Greyed out' shapes represent parts of the process that are believed to have mostly remained the same.

7.1

Important additional information on building energy models and their ecosystems

- Comparison tables of building energy models in regulations and voluntary standards
- Comparison tables of simulation tools
- In-depth reviews of selected building energy models
- In-depth reviews of selected ecosystems (regulations and standards) around building energy models

Review of energy models | Terminology

This page gives an overview of the terminology and definitions used when dealing with energy models.

It is intended to clarify and define terminology, identify when a term has overlapping meanings and finally, providing consistent categorisations.

Diagram showing modelling method categorisation

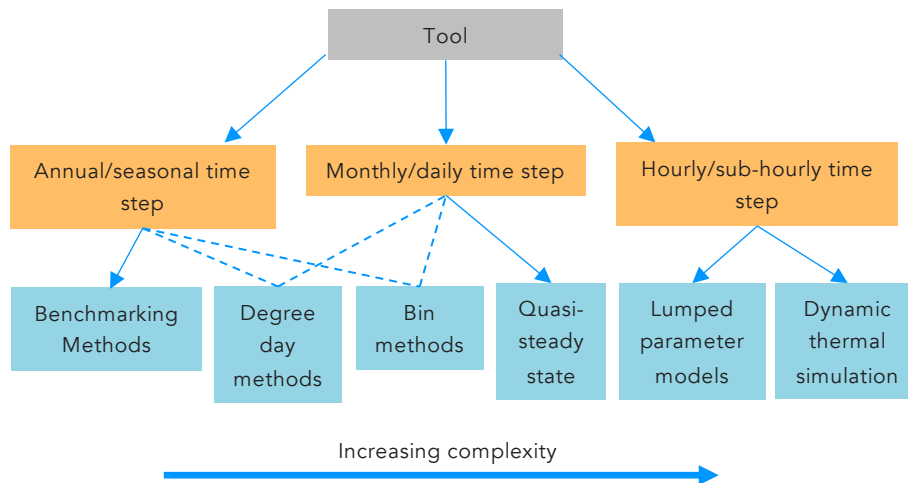

	Terminology	Definitions	Examples
(E)	Regulation	A requirement established by government mandated by law	Part L, RT2012, BR18
(E)	Policy	A requirement established by a local council	London Plan
(E)	Voluntary standard	Approved recognised standards or accepted guidance in industry	Passivhaus Standard, Minergie, Low Energy Class
(M)	Modelling method	The approach and the calculation procedures that should be implemented, and the outputs that must be generated	SAP, ASHRAE 90.2, TM54
(T)	Design tool	A tool that helps the design team understand how to achieve an outcome, for example reduced energy consumption/cost or carbon emissions	DesignBuilder, Sefaira, apache SIM application in IESVE
(T)	Simulation tool	The software that is used for energy calculations. A simulation software may have various functions, carry out compliance with various standards, and be used as a design tool. Alternatively, some simulation tools only have one function.	EnergyPlus, IESVE, TAS, PHPP, JPA, IDA-ICE
	Energy model	<i>The term energy model has been used as a generic term that encompasses ecosystems, modelling methods and/or tools.</i>	

(E) Ecosystems - Regulation, policy and voluntary standards. These often form the framework that encompasses the modelling methodologies.

(M) Modelling methodologies - Modelling methodologies used in regulatory compliance and voluntary standards.

(T) Tools - Simulation tools used to implement regulations and voluntary standards and best practice design tools for additional or bespoke energy calculations.

Building Energy Models | Regulations - Europe

Regulation	Country	Use Type	Building type	Ability to enable Net Zero	In use data disclosure	Carbon emissions kgCO ₂ /m ²	Space heating demand/ thermal energy demand	Energy rating - cost	Energy use consumption kWh/m ²	Primary energy	Another type of metric	Metric for renewables	Options for a prescriptive path
Part L	UK	Dom	NB	Low		✓ regulated only	✓	✓ EPC regulated only					
DEAP	Ireland	Dom	NB & EB	Low		✓		✓ EPC regulated only		✓ regulated only		✓ renewable energy ratio	
BBR	Sweden	Dom & Non Dom	NB & EB	Medium	✓					✓ ¹ EPC regulated only	✓ ²		
French Thermal Regulation RT 2020	France	Dom & Non Dom	NB & EB	High		✓				✓ Regulated + white goods		✓ as part of overall "net positive" target	
BENG	Netherlands	Dom & Non Dom	NB	High			✓			✓ ³		✓	
CTE	Spain	Dom & Non Dom	NB & EB	Low		✓ EPC regulated only				✓			
TEK17	Norway	Dom & Non Dom	NB & EB	Medium					✓			✓	✓
BR18	Denmark	Dom & Non Dom	NB & EB	Medium			✓ ⁴			✓ ¹ regulated only			
GEG 2020	Germany	Dom & Non Dom	NB & EB	Medium						✓ regulated only	✓ ⁵ regulated only	✓	
National code of Finland	Finland	Dom & Non Dom	NB & EB	Medium			✓ ⁴			✓ ⁶ EPC			
SIA 380/1	Switzerland	Dom & Non Dom	NB & EB	Medium							✓ ⁵ regulated only		

Key

Modelled relative target	✓
Modelled absolute target	✓
In use	✓
Unknown if absolute or relative target	✓

Acronyms	Meaning
Dom	Domestic
Non Dom	Non Domestic
NB	New Buildings
EB	Exiting Buildings

1. Excludes lighting for homes
2. Robust limiting average parameters for U-values
3. BENG states 'yearly primary use of fossil energy' which is understood to be primary energy
4. Heat loss metric in W/m²
5. Heating and hot water demand + regulated electricity consumption from ventilation and lighting
6. E-luku factor used, similar to primary energy

Building Energy Models | Voluntary standards - Europe

Standard	Country	Use Type	Building type	Ability to enable Net Zero	In use data disclosure	Carbon emissions kgCO ₂ /m ²	Space heating demand/ thermal energy demand	Energy rating - cost	Energy use consumption kWh/m ²	Primary energy	Another type of metric	Metric for renewables	Options for a prescriptive path
Passivhaus	Germany	Dom & Non Dom	NB	High			✓ ¹			✓		✓ ³	
Minergie	Switzerland	Dom & Non Dom	NB & EB	High					✓			✓	
FEBY (Forum för Energieeffektivt Byggnade)	Sweden	Dom & Non Dom	NB & EB	Medium			✓ ¹			✓ ² regulated only			
Low Energy Class (replacing Building Class 2020)	Denmark	Dom & Non Dom	NB & EB	Medium-high			✓ ¹			✓ ² regulated only			
The DGNB Climate Positive Award	Germany	Dom & Non Dom	NB & EB	High	✓	✓			✓			✓	

Acronyms	Meaning
Dom	Domestic
Non Dom	Non Domestic
NB	New Buildings
EB	Exiting Buildings

1. Heat loss metric expressed in W/m²
2. Excludes lighting for homes
3. In Passivhaus Plus and Premium

Key

Modelled relative target	✓
Modelled absolute target	✓
In use	✓
Unknown if absolute or relative target	✓

Building Energy Models | Regulations & Voluntary Standards - USA/Canada/Australia

Regulation	Country	Use Type	Building type	Ability to enable Net Zero	Data disclosure	Carbon emissions kgCO ₂ /m ²	Space heating demand/ thermal energy demand	Energy cost	Energy use consumption kWh/m ²	Net zero energy balance	Another type of metric	Metric for renewables	Options for a prescriptive path
City of Toronto's Zero Emission Building Framework	CND	Dom & Non Dom	NB	High	✓ ¹	✓	✓		✓			✓	
Vancouver Zero Emissions Building Plan	CND	Dom & Non Dom	NB	High	✓	✓	✓		✓				
British Columbia Step Code	CND	Dom & Non Dom	NB	High			✓ ✓ ²		✓ ³		✓ ³		
Washington DC Appendix Z	USA	Dom & Non Dom	NB	High	✓		✓		✓	✓		✓	
California (Title 24, parts 1,6)	USA	Dom & Non Dom	NB	High	✓ ¹						✓ ⁴	✓	✓
City of Boulder Energy Conservation Code - Performance Path	USA	Dom & Non Dom	NB	High	✓				✓				
Seattle Performance Path	USA	Dom & Non Dom	NB	High	✓				✓				
NatHERS	AUS	Dom	NB	Low			✓						
Voluntary standards													
ILFI Zero Energy Certification	USA	Dom & Non Dom	NB & EB	High	✓					✓		✓	
CaGBC Zero Carbon Building Standard	CND	Dom & Non Dom	NB & EB	High	✓ ⁵		✓		✓	✓			
Zero Code - California	USA	Dom & Non Dom	NB	High	✓ ¹				✓	✓	✓ ⁴	✓	

Acronyms	Meaning
Dom	Domestic
Non Dom	Non Domestic
NB	New Buildings
EB	Exiting Buildings

1. There is no disclosure requirement within this standard, but buildings of a certain size must report energy consumption, as part of a different requirement
2. For the Step Code there are options for absolute or comparative targets
3. Either a comparative energy use metric is required or an absolute Mechanical energy use MEUI is required
4. TDV - a time dependant value weight is applied to the energy consumption results from the model
5. The design standard has no data disclosure requirement, as it certifies Net Zero in design. The performance standard, is based purely on data disclosure, as it is an in-use standard

Key

Modelled relative target	✓
Modelled absolute target	✓
In use	✓

Building Energy Models | Voluntary standards – Existing Buildings

Regulation	Country	Use Type	Building type	Ability to enable Net Zero	Data disclosure	Carbon emissions kgCO ₂ /m ²	Space heating demand/ thermal energy demand	Energy rating - cost	Energy use consumption kWh/m ²	Another type of energy use metric	Primary energy	Bills	Metric for renewables	Options for a prescriptive path
EnerPHit	Germany	Dom & Non Dom	EB	High			✓				✓			
Energiespron g UK	UK adapted from the Netherlands	Dom	NB & EB	High	✓		✓			✓ ¹			✓	
Better Home	Denmark	Dom	EB		✓				✓					
My Home Energy Planner	UK	Dom	EB		✓		✓							
Whole House Plan	UK	Dom	EB		✓	✓		✓				✓		
Passeport Efficacité Energétique	France	Dom	EB		✓						✓			
Woningpas	Belgium	Dom	EB		✓						✓			✓
iSFP	Germany	Dom	EB		✓				✓					

Acronyms	Meaning
Dom	Domestic
Non Dom	Non Domestic
NB	New Buildings
EB	Exiting Buildings

1. kWh per annum allowance for lighting, cooking and sockets

Key

Modelled relative target	✓
Modelled absolute target	✓
In use	✓
Unknown if absolute or relative target	✓

Building Energy Models | Other simulation tools

Tool	Country	Use Type (Domestic/Non-domestic)	Building type (New/Refurb)	Method	Scope	Complexity	Indicator Type	Accreditation scheme	Software Cost
SAP tools (i.e. Elmhurst, FSAP, JPA, etc)	UK	Domestic	All	Steady-State	Regulation	Low	Absolute & comparative for BRs	Paid tutorials	Free or Low
EnergyPlus	US	All	All	DSM	Design	High	Absolute	Free documentation, also paid tutorials	Free
Design Builder	UK	All	All	DSM	Design/ Regulation	High	Absolute & comparative for BRs	Paid tutorials	Low/Medium
Sefaira	UK	All	All	DSM	Design	Medium	Absolute	Paid tutorials	Medium
EDSL TAS	UK	All	All	DSM	Design/ Regulation	High	Absolute & comparative for BRs	Paid tutorials	High*
IES	UK	All	All	DSM	Design/ Regulated	High	Absolute & comparative for BRs	Paid tutorials	High*
Open Studio	US	All	All	DSM	Design	High	Absolute	Online tutorials	Free
Thermo 7	Swiss	All	All	Steady-State	Design/ Regulation	Low	Absolute & comparative for BRs	No need for accreditation but signed off by CEng	Low
Simien 7.0	Norway	All	All	DSM	Design/ Regulation	Low/Medium	Absolute	Unknown	Low/Medium
eQuest	Canada	All	All	DSM	Design	Medium	Absolute	Online tutorials	Free
Honeybee	US	All	All	DSM	Design	High	Absolute	Free online but also paid tutorials	Free
HULC (LIDER-CALENER Unified Tool)	Spain	All	All	DSM	Regulated	Medium	Comparative for BRs	Official courses developed for dissemination	Unknown
Be18	Denmark	All	All	Steady-State	Design	Medium	Absolute	Not for B.Reggs, yes for EPC	Low
IDA-ICE	Finland	All	All	DSM	Design/ Regulation	Medium	Absolute & comparative	Free online but also paid tutorials	Low

Acronyms	Meaning
Dom	Domestic
Non Dom	Non Domestic
NB	New Buildings
EB	Exiting Buildings

Cost per user per annum

Free	No cost
Low	<£1,500
Medium	£1,500 - 2,000
High	>£3,000 +
*	Perpetual licenses

Building Energy Models | Other simulation tools - Metrics

Tool	Country	Use Type	Building type	Ability to enable Net Zero	Carbon emissions kgCO ₂ /m ²	Dwelling fabric efficiency	Energy cost rating	Energy use consumption kWh/m ²	Outputs	Overheating	Daylight
SAP tools (e.g. Elmhurst, FSAP, JPA)	UK	Domestic	All	Low	✓	✓	✓ _{EPC}	✓	Regulated in kWh	Basic	No
EnergyPlus	US	All	All	High	✓			✓	All in kWh/m ²	Dynamic	Yes
Design Builder	UK	All	All	High			✓ _{EPC}	✓	All in kWh/m ²	Dynamic	Yes
Sefaira	UK	All	All	Low				✓	All in kWh/m ²	Yes	Yes
EDSL TAS	UK	All	All	High	✓		✓ _{EPC}	✓	All in kWh/m ²	Dynamic	Yes
IES	UK	All	All	High	✓		✓ _{EPC}	✓	All in kWh/m ²	Dynamic	Yes
Open Studio	US	All	All	High	✓			✓	All in kWh/m ²	Dynamic	Yes via EnergyPlus/ Radiance
Thermo 7	Swiss	All	All	High				✓	All end uses in MJ/m ² and kWh/m ²	None	None
Simien 7.0	Norway	All	All	High				✓	All in kWh/m ²	Ability to do Dynamic	No
eQuest	Canada	All	All	Medium				✓	All in kWh/m ²	None	None
Honeybee	US	All	All	High				✓	All in kWh/m ²	Dynamic (EnergyPlus)	Yes
HULC (LIDER- CALENER Unified Tool)	Spain	All	All	Medium/Low	✓ _{EPC}			✓ _{EPC}	Unknown	No	No
Be18	Denmark	All	All	High				✓	All in kWh/m ²	Basic	No
IDA-ICE	Finland	All	All	Medium	✓	✓		✓	All in kWh/m ²	Dynamic	Yes

Acronyms	Meaning
Dom	Domestic
Non Dom	Non Domestic
NB	New Buildings
EB	Exiting Buildings

Key

Modelled relative target	✓
Modelled absolute target	✓

7.2

Important additional information on building energy models and their ecosystems

- In-depth reviews of selected building energy models
- In-depth reviews of selected ecosystems (regulations and standards) around building energy models

Building Energy Models | In-depth review: SAP (2012 and 10.1)

Summary

Energy model	SAP
Purpose	Standard Assessment Procedure for energy rating of dwellings. Based on the BRE Domestic Energy Model (BREDEM)
Use type	Domestic new build and existing
Location	UK
Scope	UK Regulated energy (excl. external lighting, lifts, appliances, other equipment)
Simulation tool	Various software



Metrics and associated targets (linked to Part L)

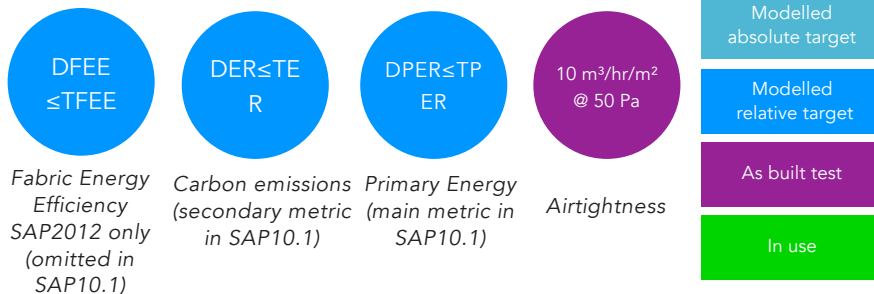

Further Requirements (in the method itself or the associated Part L)

In - use energy disclosure	None
Proven track record against actual in-use performance	None
Any as built tests required	Building Regulations require a minimum number of sample/typologies of dwellings to be tested, with a penalty. In England and Wales this is proposed to be changed under 2020/21 Part L updates (under consultation), with all dwellings requiring testing
Other Requirements (e.g. for regular inspection of heating and AC system)	None
Performance or prescriptive	Performance (with prescriptive elements)
Limiting parameters	Limiting building fabric and air permeability

Calculation process

Modelling method categorisation	Steady state - Monthly degree day model
Time required for inputs	Quick
Training and accreditation schemes/requirements for the modeller	Technically should be trained (although many companies give credentials of trained staff to junior staff), two or five day courses are available depending on software provider.
Level of complexity	Medium when carried out correctly
Which standard does it use	Based on BREDEM with procedure following BS EN13790
Calculation by apartment or by building	Calculation carried out per dwelling
Heating demand calculation	Based on average external temperature, heat loss rate for mean internal temperature, useful gains, utilisation factor for gain and fraction of month for heating.
Standard assumptions	Standard occupancy and profiles, with gains from hot water, cooking and appliances based on occupancy.
Bespoke assumptions	Energy saving technologies (renewables)
Futureproofing	
Does it address any other building performance aspects	Simplified overheating risk calculation is included with a threshold of 23.5°C (air flow options have been refined for SAP10.1).
Treatment of emerging trends e.g. peak demand, demand management, electric vehicles charging	None for SAP2012 Allowance for solar thermal space heating and battery storage with PV installation in SAP10.1.
Ability to respond to key policy, market and technology trends tests	Mechanical ventilation, heating systems, hot water and renewables have the option to input 'manufacture declared' data. (WWHR systems have been added to SAP10.1).

Building Energy Models | In-depth review: SAP (2012 and 10.1)

Inputs

Weather file	Energy calculations are carried out using an East Pennines weather file, not the actual location of the development. However for renewable generation and overheating calcs, SAP uses 21 different climatic regions (temperature, wind speed and solar radiation for PV).
Building geometry	Heat loss surface areas including window glazing areas, Internal floor area, main living space area and volume, thermal bridge lengths
Building fabric parameters	Element U-values (overall window with frame factor), glazing g-values Construction thermal mass (low/medium/high or detailed option) Wind exposure (based on sheltered sides) Airtightness Optional thermal bridge psi-values including details of window frames Window overshadowing (overhang or window reveal dimensions)
Building service parameters	Heating: Data of system efficiency, heating controls Hot water: hot water tank volume, and heat loss factor or insulation thickness. Hot water demand: blanket assumption based on floor area, but allowing lower level (105l/p/day) in line with optional building regulations standards; shower flow rates, in SAP 10.1. WWHR can link to individual showers in SAP10.1 Ventilation: supply and extract Specific Fan Power (SFP), heat recovery efficiency, number of wet rooms, duct types (i.e. rigid, flexible) Lighting: % of efficient lamp fittings (lm/W); number of fittings and their efficiency, in SAP10.1
PV	Orientation, inclination, kWp and overshadowing; (PV diverter, battery storage capacity, in SAP 10.1)
Complexity for inputting heating and hot water system	Medium complexity: Data of system efficiency, heating controls, hot water tank volume, and heat loss factor or insulation thickness
Complexity for inputting ventilation systems	Medium complexity: There are choices between natural ventilation, mechanical ventilation with or without heat recovery.
Complexity for inputting thermal bridges	Low complexity option: Inputting a y-value (SAP2012) Highly complexity option: inputting individual information for each junction (length and psi-value) (SAP2012 and SAP10.1)

Building Energy Models | In-depth review: PHPP

Summary

Energy model	PHPP
Purpose	Passivhaus Standard certification
Use type	Domestic and most non-domestic, new build & existing buildings
Location	German Standard, used all over the world
Scope	All energy use
Simulation tool	PHPP (Passivhaus Planning Package)

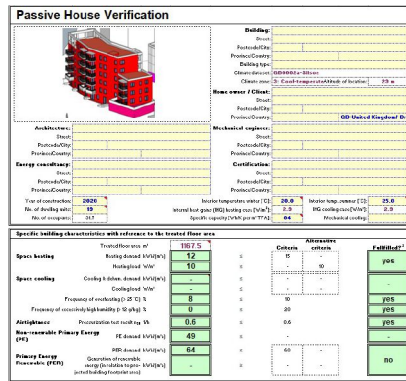

Metrics and targets

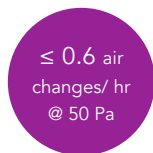

Space Heating Demand

Primary Energy Renewables

Airtightness

Modelled absolute target
Modelled relative target
As built test
In use

Further requirements

In- use energy disclosure	None
Proven track record against actual in-use performance	Yes
Any as built tests required	Airtightness test for whole building
Other Requirements (e.g. for regular inspection of heating and AC system)	Optional third party check of calculation by independent certifier
Performance or prescriptive	Performance based, although prescriptive airtightness requirements apply and optional construction quality assurance process possible
Limiting parameters	Airtightness

Main differences with SAP

Metrics	Absolute metrics based on space heating demand and primary energy renewables (i.e. primary energy using conversion factors of an energy system dominated by renewable energy)
Open source (not sure this is right name)	PHPP is an open access spreadsheet. All formulas and assumptions can be seen and could be changed, giving flexibility for calculations, but also potential for tampering.
Heating, hot water and ventilation system	The systems are input in a much more detail than SAP and specific to the project, including hot water distribution pipework lengths and diameters.
Treatment of unheated spaces e.g. corridors	In PHPP all areas within the thermal envelope are included. In SAP walls to unheated corridors are assumed to be external (with a correction factor to estimate heat loss)
Solar gains	Calculated in detail with a shading coefficient per window
Internal gain	In validation mode, PHPP fixes the internal gains from hot water, appliances, hot water and people at 2.1 W/m ² . In design mode, changes can be made to this fixed assumption to reflect real conditions. SAP assumes gains from hot water and appliances based on standard occupancy. The PHPP limit on internal gains from people and appliances maintains the standard to which the fabric is designed. Internal gains from appliances can be amended in PHPP but not SAP
Philosophical approach to achieving accuracy	In validation mode, PHPP assumptions default to a worse value, thus making compliance harder to achieve. This incentivises to use the software as a design tool. Some of the assumptions in SAP default to a more energy-efficient answer than the likely reality, making compliance easier.
Validation	PHPP is calibrated against measured data from over 500 buildings built to the Passivhaus standard.
Thermal bridges	Calculation of heat loss areas in PHPP is based on external dimensions, not on internal dimensions like SAP. This is a cautious approach overestimating heat loss and meaning less thermal bridge calculation is needed. Thermal bridging is also calculated in much more detail
Ventilation system	Systems are modelled and takes account of the design of the system as a whole including heat losses from cold ducts.
Measurement of air infiltration	Air leakage rate in air changes/hour @ 50 Pa whereas in SAP it is air permeability in m ³ /(h. m ²)@ 50 Pa.
Shading	Detailed inputs on depths of window reveal per window and shading factor input per window for summer and window shading

Building Energy Models | In-depth review: PHPP

Calculation process

Modelling method categorisation	Steady state- Monthly or annual degree day model
Time required for inputs	Slow
Training and accreditation schemes/requirements for the modeller	No formal user training requirement. However, a Passivhaus Designer Course is recommended which covers not only PHPP but low energy design and construction as well. This is very useful to ensure that energy modellers understand the implications of their assumptions.
Level of complexity	Medium
Which ISO does it use	Monthly or annual degree day model based on EN13790
Calculation by apartment or by building	Calculation carried out for the whole building
Heating demand calculation	Total heat loss minus all incidental gains- including hot water and appliances. Degree day method used.
Standard assumptions	Occupancy density and patterns Internal heat gains Profiles for DHW, heating, lighting, cooling ventilation Lighting use and controls
Bespoke assumptions	Temperature set points for heating Energy consumption of appliances, pipe lengths, duct lengths

Futureproofing

Does it address any other building performance aspects	Rudimentary overheating calculation is included
Treatment of emerging trends e.g. peak demand, demand management, electric vehicles charging	Peak heating demand is calculated. Demand management and EVs are not included.
Ability to respond to key policy, market and technology trends tests	As the tool is an excel spreadsheet you can pull out key pieces of information easily. Details of systems can be input hence changes in technology can be incorporated

Inputs

Weather file	External weather file based on region (22 regions in the UK)
Building geometry	External heat loss surface area including window glazing areas and frame sizes Internal floor area and volume Significant thermal bridge lengths (<i>not all thermal bridges are input, unusual to be more than 5-10</i>)
Building fabric parameters	Element U-values (glazing and frame separately) Construction thermal mass (single value) Wind exposure Airtightness Thermal bridge psi-values including details of window frames Glazing g-values Window shading (detailed inputs- window reveal and summer/winter)
Building service parameters	Heating: Detailed data of efficiency of systems, heating pipe length, temperatures and insulation thickness and thermal conductivity Hot water: hot water cylinder size and heat loss rate, hot water pipe length, temperatures and insulation thickness and thermal conductivity. Number of tapping points Ventilation: supply and extract rates, heat recovery efficiency, electric efficiency, duct lengths and insulation properties Lighting: average lamp efficiency (lm/W) Auxiliary: pump power specified
PV	Area, orientation, inclination, kWp output and inverter efficiency
Complexity for inputting heating and hot water system	High complexity: Heating and hot water systems are modelled in a great level of detail. Performance data for heat pumps under different external temperatures and capacities included. For hot water number of tapping points included.
Complexity for inputting ventilation systems	High complexity: Each individual ventilation unit is inputted including flow rates, along with duct lengths. Calculation includes energy for frost protection
Complexity for inputting thermal bridges	Medium complexity: External dimension approach reduces number of thermal bridge entries. Remaining input is flexible and can be complex. Thermal bridge psi-values for each windows frame as well as linear thermal bridges (length and psi values)

Building Energy Models | In-depth review: DSM with CIBSE TM54 methodology

Summary

Energy model	CIBSE TM54 methodology with Dynamic Simulation Modelling
Purpose	Evaluation of operational energy by end-use
Use type	Domestic and non-domestic buildings
Location	UK methodology
Scope	All energy use incl. lifts
Simulation tool	IES/TAS/EnergyPlus

Evaluating operational energy performance of buildings at the design stage

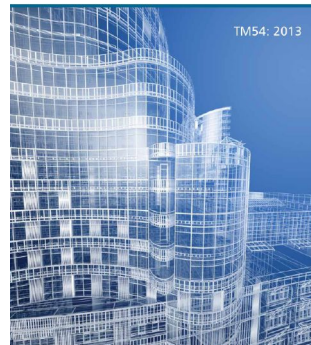

Metrics and targets



Energy targets



Energy Benchmarks

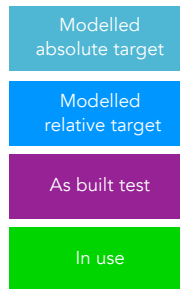

Further requirements

In- use energy disclosure	None
Proven track record against actual in-use performance	Results closer to recorded data
Any as built tests required	Not required
Other Requirements (e.g. for regular inspection of heating and AC system)	None
Performance or prescriptive	Performance based
Limiting parameters	None

Main differences with SAP

Metrics	Absolute metrics based on space heating demand and energy consumption
Heating, hot water and ventilation system	The systems are input in a much more detail in a project specific manor with different systems included for relevant spaces
Treatment of unheated spaces- ie corridors	Un heated spaces are defined and included and any heat loss and gains from these spaces are included in the calculation
Solar gains	DSM calculation is more detailed
Internal gain assumptions	All inputs can be bespoke to reflect project specific conditions
Internal gains	All inputs can be bespoke to reflect project specific conditions
Philosophical approach to achieving accuracy	All inputs can be bespoke to reflect project specific conditions
Validation	This methodology can be carried out in design stage, construction stage (to capture any design and system changes) and could be calibrated against real energy data post construction and use
Thermal bridges	Thermal bridging is not calculated in more detail as SAP as only a % is required, however hand calculations can be carried out and the % adjusted to reflect the design
Ventilation system	Systems are modelled and takes account of the design of the system as a whole including duct lengths and their insulation
Measurement of air infiltration	Air leakage rate added as infiltration in air changes, l/s, l/(sm ²), l/s/person, l/(sm ² fac)
Shading	Shading can be accurately included in the 3D geometry, there is also the option to insert blinds (internally or externally) at the glazing construction inputs

Building Energy Models | In-depth review: DSM with CIBSE TM54 methodology

Calculation process

Modelling method categorisation	Dynamic Simulation Modelling with additional hand calcs on 'unregulated' energy
Time required for inputs	High
Training and accreditation schemes/requirements for the modeller	CIBSE TM54 doesn't specify any training, however it requires any DSM modelling to follow the CIBSE AM 11. CIBSE TM54 refers to adjusting Building Compliance models to carry out the required DSM, which in line should be undertaken by Low Carbon Energy Assessors. Trained by the relevant software provider and accreditation scheme.
Level of complexity	High
Which ISO does it use	Various ISO standards, depending on specific calculation, i.e. BS ISO25745-1 for lift calcs
Calculation by apartment or by building	Either
Heating demand calculation	Based on CIBSE weather files, heating consumption calculated with DSM.
Standard assumptions	None
Bespoke assumptions	All assumptions

Futureproofing

Does it address any other building performance aspects	The methodology is specific to operational energy use
Treatment of emerging trends e.g. peak demand, demand management, electric vehicles charging	Lifts, emergency lighting, etc., should all be included, as well as a management factor.
Ability to respond to key policy, market and technology trends tests	Bespoke assumptions, with any new technology to be taken into account

Inputs

Weather file	CIBSE 2016 (or later) weather files
Building geometry	Detailed 3D building geometry as per CAD DWGs used for DSM
Building fabric parameters	Opaque element U-values Glazing U-value, g-value, light transmittance, frame factor Construction thermal mass as per construction build-up Wind exposure as per weather file and 3D geometry Airtightness Thermal bridge % factor per construction element Window overshadowing, eternal as per 3D geometry, or blinds, etc added to glazing element.
Building service parameters	Heating: Detailed data of efficiency of systems, heating pipe length, temperatures and insulation thickness, etc Hot water: hot water cylinder size and heat loss rate, hot water pipe length, temperatures and insulation thickness and efficiency Ventilation: supply and extract rates, heat recovery efficiency Lighting: average lamp efficiency (lm/W or W/m ²) Auxiliary: pump power specified
PV	Area, orientation, inclination, efficiency
Complexity for inputting heating and hot water system	Medium/high for standard DSM, very high complexity if HVAC analysis used
Complexity for inputting ventilation systems	Medium/high for standard DSM, very high complexity if HVAC analysis used
Complexity for inputting thermal Bridges	Low complexity, as a % factor is added to each building/construction element

Building Energy Models | In-depth review: Minergie

Summary

Energy model	Minergie
Purpose	Voluntary certification
Use type	Domestic and non-domestic new build
Location	Switzerland
Scope	All energy use
Simulation tool	Tools based on SIA380/1 regs and tools such as Thermo 7

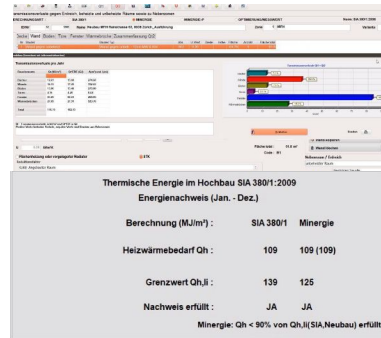

SIA380 tool screenshot incl. Minergie

Metrics and targets



Further requirements

In- use energy disclosure	None
Proven track record against actual in-use performance	Limited available data
Any as built tests required	Airtightness test per dwelling
Other Requirements (e.g. for regular inspection of heating and AC system)	None
Performance or prescriptive	Performance with prescriptive airtightness requirements
Limiting parameters	Building fabric and airtightness

Main differences with SAP

Metrics	Comparative of each end-use to 10% improvement upon SIA380/1 baseline
Thermal envelope approach	For planning SIA 380/1 requires a detailed description and a section of the proposed build-ups for all fabric elements, i.e. not just a proposed U-value, but also a technical description of the way in which works will be undertaken on site. Encourages good design from early design stages with audits throughout stages.
Heating, hot water and ventilation system	Similar to SAP, with 2 heating set-points
Treatment of unheated spaces e.g. corridors	Minergie includes all areas within the thermal envelope, such as corridors. In SAP walls to unheated corridors are assumed to be external (with factors applied)
Solar gains	Simple method checking basic overheating criteria and if it highlights risk, DSM can be carried out
Internal gain assumptions	SIA 380/1 and Minergie has standard value
Internal gains	Based on SIA 380/ standard inputs per m ² and use type
Philosophical approach to achieving accuracy	Minergie has more stringent targets in relation to SIA 380/1, thus making compliance harder to achieve. This leads to a thermal envelope with an enhanced thermal performance.
Validation	Limited data available, however as Minergie and SIA 380/1 focus on the best possible design with the lowest demand, regulated real-time energy is expected to be low.
Thermal bridges	Standard design to include very Low (good) thermal bridging, backed up with drawings to show compliance of 'very good' thermal bridges to be submitted and checked by auditors. At early stage they force to over-estimate to approximately 20% to encourage other parameters to achieve better design requirements.
Ventilation system	MVHR required for Minergie (no natural ventilation), ventilation loss input ach only. Standard 0.7 m ³ /m ² h
Measurement of air infiltration	Air leakage rate as in SAP Air permeability in m ³ /m ² h @ 50 Pa.
Shading	External shading is compulsory, i.e. external venetians blinds/brise soleil, closed cavity façade for high buildings

Building Energy Models | In-depth review: Minergie

Calculation process

Modelling method categorisation	Steady state
Time required for inputs	Similar to SAP
Training and accreditation schemes/requirements for the modeller	No formal user training requirement. Course exists but there is no accreditation.
Level of complexity	Medium for Basic Minergie, however for Minergie A- energy neutral, it is more complex. Experience is required.
Which ISO does it use	
Calculation by apartment or by building	Calculation carried out for the whole building
Heating demand calculation	Total heat loss minus all incidental gains- including hot water and appliances. Degree day method used and based on 2-3 setpoints
Standard assumptions	Occupancy density and patterns Profiles for DHW, heating, lighting, cooling ventilation Lighting controls
Bespoke assumptions	Set points for heating based on building use Fabric inputs to get a very low energy demand Air tightness strategy

Futureproofing

Does it address any other building performance aspects	Overheating calculations are included, if basic test fails auditors require a DSM to be carried out and further analysis of design. External shading is compulsory for all buildings.
Treatment of emerging trends e.g. peak demand, demand management, electric vehicles charging	Peak heating demand as separate studies based on SIA 380/1 outputs
Ability to respond to key policy, market and technology trends tests	Some key local polices of boroughs/district have further requirements, i.e. additional renewable technologies, etc.

Inputs

Weather file	A numbers of region based degree days
Building geometry	Heat loss surface area including window glazing areas External floor area and volume Thermal bridge lengths
Building fabric parameters	Opaque thermal element U-values (200mm for Minergie Basic, 300mm min insulation for Minergie-P) Glazing U-values & g-values Construction thermal mass Wind exposure Airtightness Thermal bridge psi-values – promotes low thermal bridges Window overshadowing
Building service parameters	Heating: Detailed data of efficiency of systems, based on 2-3 different setpoints Hot water: hot water cylinder size and heat loss rate. Ventilation: ventilation losses at a standard rate of 0.7 m ³ /m ² h Lighting: average lamp efficiency (lm/W) and controls.
PV	Minimum requirement of 10W/m ² per house/block of flats. For Minergie-A, all energy demand must be supplied by renewable technology (such as Net Zero)
Complexity for inputting heating and hot water system	Medium complexity: Heating and hot water systems are modelled with 2-3 different setpoints depended on building use or climate. Performance data for heat pumps included.
Complexity for inputting ventilation systems	Medium/low complexity: Single value for ventilation rate for the whole building.
Complexity for inputting thermal bridges	Minergie uses the SIA 380/1 building regulations process and tools to carry out the energy calculations. The tools and design procedure require a high level of complexity of detailed input. Designers are required to look into the detail of junction from early stages, that are meant to be submitted separately.
Low carbon heat	For space heating almost always a heat pump is used (GSHP common, DHN from waste, etc)

Building Energy Models | In-depth Review: CaGBC – Zero Carbon Building Design Standard

Summary

Energy model	CaGBC- Zero Carbon Building Design Standard
Purpose	Deliver buildings designed to zero carbon
Use type	Domestic and non-domestic new build
Location	Canada
Scope	All energy use
Simulation tool	Various, with results entered into NZC-V2 workbook

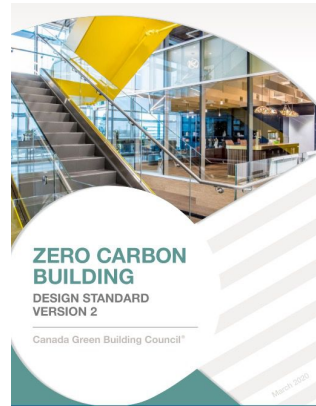

Metrics and targets



Space Heating
Demand



Energy Use
Intensity

These targets relate to one of 3 options for this standard

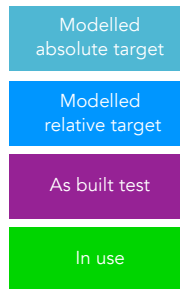

Further requirements

In- use energy disclosure	None - this is a design standard not an in-use standard
Proven track record against actual in-use performance	Unknown, relatively new standard. However, anticipated EUI should be in a reasonable ballpark
Any as built tests required	Based on modelled information
Other Requirements (e.g. for regular inspection of heating and AC system)	None
Performance or prescriptive	Performance based
Limiting parameters	None

Main differences with SAP

Outcomes of the model	The expectation is that energy models will be developed to represent the actual anticipated operation of the facility for all energy uses on site.
Metrics	Absolute metrics based on space heating demand and a relative energy use intensity metric.
Profiles (occupancy/ DHW loads)	Stipulated conditions such as schedules, occupancy, receptacle loads, and domestic hot water loads shall be based on actual intended operational conditions for the facility in question. The modeler is required to understand building operations as best as possible so that anticipated hours of operation and equipment run times are reflected in the energy model rather than relying on arbitrary defaults from software or applicable code or standards.
Internal heat gains	Incidental heat gains from lighting, pumps, fans etc shall be included in the energy model and reflect the design of the building. Operational schedules are inputted that reasonably reflect the expected operations of the building and should be developed in consultation with the building owner and/or operator.
Air leakage	By default, air leakage shall be modelled based on an assumed field-testing value. The use of a value lower than the above default rate is permitted but must be substantiated.
Peak demand calculation	By default, air leakage shall be modelled based on an assumed field-testing value. The use of a value lower than the above default rate is permitted but must be substantiated.
Renewable energy generation	Hourly electricity demand is outputted by the model and inputted into the ZCB-Design v2 Workbook, which then displayed the modelled summer and winter peak demand of the building.
Thermal bridges	Hourly renewable electricity generation must be provided by the model be entered into the ZCB-Design v2 Workbook, this can come from the simulation tool or another software that specialise in renewable energy generation.

Building Energy Models | In-depth review: CaGBC – Zero Carbon Building Design Standard

Calculation process

Modelling method categorisation	The ZCB-Design v2 Energy Modelling Guidelines
Time required for inputs	Slow
Training and accreditation schemes/requirements for the modeller	No training scheme exists
Level of complexity	High
Which ISO does it use	n/a
Calculation by apartment or by building	Calculation carried out for the whole building
Heating demand calculation	Heating demand calculated with DSM
Standard assumptions	All assumptions are bespoke although National Energy Code for Buildings (NECB) 2017 is often used as guidance
Bespoke assumptions	Occupancy density and patterns, profiles for DHW, heating, lighting, cooling ventilation, Lighting controls. Internal gains. Set points for heating, energy consumption of appliances

Futureproofing

Does it address any other building performance aspects	No
Treatment of emerging trends e.g. peak demand, demand management, electric vehicles charging	An output of the model is the summer and winter peak demand (kW)
Ability to respond to key policy, market and technology trends tests	All new technologies can be inputted in the model

Inputs

Weather file	Based on the closest representative city with simulation weather files available
Building geometry	Inputted based on a 3D model built in energy simulation software Thermal bridge lengths
Building fabric parameters	Element U-values Construction thermal mass Wind exposure Airtightness Glazing g-values Window overshadowing through 3D model
Building service parameters	Typical inputs for dynamic energy simulation based on actual design information i.e.. key equipment efficiency, performance curve, fan performance, heat recovery effectiveness, etc. Lighting is inputted based on actual lighting plans or W/m ² Pump power is dynamically modelled in the energy simulation software to account for heating and cooling demand
PV	Area, orientation, inclination, kWp output and inverter efficiency
Complexity for inputting heating and hot water system	High complexity - based on equipment data sheets
Complexity for inputting ventilation systems	High complexity - based on equipment data sheets
Complexity for inputting Thermal Bridges	High complexity - based on equipment data sheets

Building Energy Models | In-depth review: British Columbia Step Code - Energuide Compliance Path)

Summary

Energy model	Energuide for homes
Purpose	Compliance with the BC step code regulation
Use type	Domestic
Location	Canada
Scope	All energy use
Simulation tool	Hot 2000

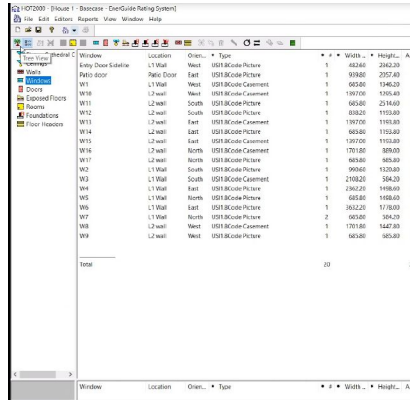

Metrics and targets

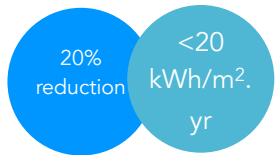

Two options for thermal Energy demand intensity* requirements

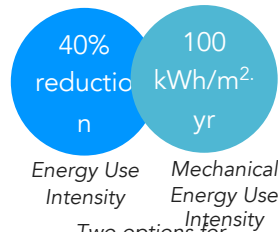

Two options for Energy Use Intensity performance requirements of systems*

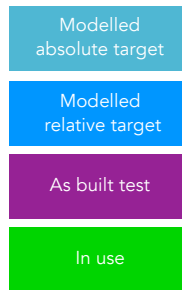

Further requirements

In- use energy disclosure	None
Proven track record against actual in-use performance	Yes
Any as built tests required	Airtightness and inspections through the construction of the building
Other Requirements (e.g. for regular inspection of heating and AC system)	None
Performance or prescriptive	Performance based
Limiting parameters	Airtightness requirements

*The targets relate to Step 3 of the code – for locations that have less than 3000 degree-days, where less than 50% of the buildings conditioned space is cooled and the area is between 51-75 m².

Main differences with SAP

Outcomes of the model	The model provides both comparative outputs to a reference building and absolute outputs
Metrics	Thermal Energy Demand Intensity (TEDI), Energy Use Intensity (EUI) and Mechanical Energy Use Intensity (MEUI)
Profiles (occupancy/ DHW loads)	For code compliance, normalised data is used, inputs can be changed for design calculations for the assumption on occupancy and appliance, change hot water loads, and set point controls
Renewable energy generation	Module efficiency and inverter efficiency are inputs
Weather file	Weather file is based on the closest city
Cooling/ overheating	Window operability affects cooling energy consumption
Thermal Bridging	Thermal bridging is calculated on key inputs rather than defined by psi- values. It is defined based on wall/ floor/ roof construction types(stud spacing depths and corners are defined). Window thermal bridges are included as the model understands the wall type and location and thickness of insulation
Precision	Although the tool is relatively simple the inputs are very precise.
Energy modeler qualification	There is a very robust energy modeler qualification process. NRCAN run the certification scheme. A week long training course is followed by mentoring sessions, then 5 energy models must be completed and reviewed and then 2 exams completed. The first few models are audited. The auditing process is robust, a senior modeler completes a model of the same building, and if the results are off by 5% then the modeler fails and is required to go through re-training.

Building Energy Models | In-depth review: British Columbia Step Code - Energuide Compliance Path

Calculation process

Modelling method categorisation	Monthly steady state model
Time required for inputs	Quick
Training and accreditation schemes/requirements for the modeller	Yes - a very robust training scheme
Level of complexity	Low (but accuracy and precision is high)
Which ISO does it use	n/a
Calculation by apartment or by building	One calculation carried out each home, unless the units are stacked and then its one calculation per stacked group. Up to 32 units in one model.
Heating demand calculation	Degree day calculation
Standard assumptions	Occupancy density and patterns, profiles for DHW, heating, lighting, cooling ventilation, Lighting controls. Internal gains. Set points for heating, energy consumption of appliances
Bespoke assumptions	HVAC systems and geometry

Futureproofing

Does it address any other building performance aspects	No. But you can use the information in the model to consider overheating.
Treatment of emerging trends e.g. peak demand, demand management, electric vehicles charging	No
Ability to respond to key policy, market and technology trends tests	No

Inputs

Weather file	Weather file is based on the closest city
Building geometry	Input areas manually
Building fabric parameters	Element U-values Construction thermal mass Wind exposure Airtightness Glazing g-values shading
Building service parameters	Basic system type, distributions and parameters
PV	Area, orientation, inclination, module efficiency and inverter efficiency (doesn't account for shading)
Complexity for inputting heating and hot water system	Low complexity: Based on selecting systems and updating performance based on installed model numbers
Complexity for inputting ventilation systems	Low complexity: Based on selecting systems and updating performance based on installed model numbers
Complexity for inputting thermal bridges	Medium complexity: Wall/ floor/ roof construction types

Building Energy Models | In-depth review: Norwegian Building Regulations

Summary

Energy model	Norwegian Building Regulations TEK17
Purpose	Regulation: to reduce energy use of new and existing buildings
Use type	Domestic and non domestic new buildings and refurbishments
Location	Norway
Scope	Regulated and unregulated energy
Simulation Tool	Simien 6.007 or v7



Regulations on technical requirements for construction works

An unofficial English translation of the regulation "Paradigmet er et teknisk krav til byggingens tekniske krav" 2017 for information purposes. Any disputes shall be decided on the basis of the formal regulation in Norwegian.

001 2017



Metrics and targets

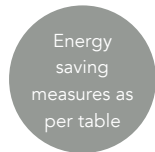

Energy Consumption (Regulated & Unregulated) Houses >150m² of heated gross internal space *

*The target for blocks of flats is 95 kWh /m²

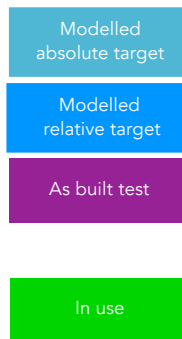

Further requirements

In- use energy disclosure	None
Proven track record against actual in-use performance	
Any as built tests required	Airtightness test per dwelling
Other Requirements (e.g. for regular inspection of heating and AC system)	Prescriptive energy saving measures for building fabric, air leakage and thermal bridging
Performance or prescriptive	Performance demand & prescriptive building fabric requirements apply
Limiting parameters	Best practice fabric and airtightness

Main differences with SAP

Metrics	Absolute energy consumption (energy consumption includes heating, cooling, lighting, ventilation, auxiliary, internal and external small power linked to the property, and energy generated on site, i.e. PVs, or any renewable technology that are within the properties boundaries.) The energy consumption target is Net of renewable energy generation. Or there is a prescriptive building fabric route
Heating, hot water and ventilation system	Blocks of flats are required to have a central heating system
Calculation process	
Modelling method categorisation	Either steady-state or DSM modelling using software such as Simien 7.0 can be used for energy requirements and detailed thermal bridging calculations
Time required for inputs	Steady-state option is similar to SAP, DSM method would take longer than SAP, prescriptive method less time than SAP
Level of complexity	Low complexity for steady state and medium complexity for DSM
On-site renewable electricity	If a minimum renewable production of 20 kWh/m ² is produced on site, the energy consumption target can increase by 10 kWh/m ²
Futureproofing	
Further steps	The Norwegian norms for energy calculations of passive house buildings (Passivhaus) are NS 3700 and NS 3701, developed and based on the German Passivhaus. Simien can be used for the Norwegian Passivhaus calculations

Prescriptive route outlined:

	Energy-saving measures	Small house	Block of flats
1.	U-value outer walls [W/(m ² K)]	≤ 0.18	≤ 0.18
2.	U-value roof [W/(m ² K)]	≤ 0.13	≤ 0.13
3.	U-value floors [W/(m ² K)]	≤ 0.10	≤ 0.10
4.	U-value windows and doors [W/(m ² K)]	≤ 0.80	≤ 0.80
5.	Proportion of window and door areas of heated gross internal area	≤ 25%	≤ 25%
6.	Annual mean temperature efficiency ratio for heat recovery systems in ventilation systems (%)	≥ 80%	≥ 80%
7.	Specific fan power (SFP) in ventilation systems [kW/(m ³ /s)]	≤ 1.5	≤ 1.5
8.	Air leakage rate per hour at 50 Pa pressure difference	≤ 0.6	≤ 0.6
9.	Normalised thermal bridge value, where m ² is stated as heated gross internal area [W/(m ² K)]	≤ 0.05	≤ 0.07

Building Energy Models | In-depth review: France RT

Summary

Energy model	RT2012 and RT2020
Purpose	Regulation
Use type	Domestic and non-domestic new build
Location	France
Scope	RT2012 : regulated energy uses; RT2020: same + white goods
Simulation tool	Several approved tools: e.g. Climawin, Pleiades+Comfie

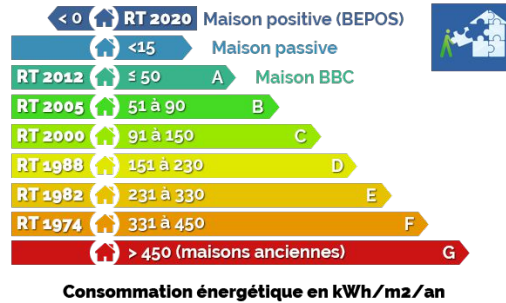

RT2020 does not only require energy efficiency but renewable energy generation

Metrics and targets

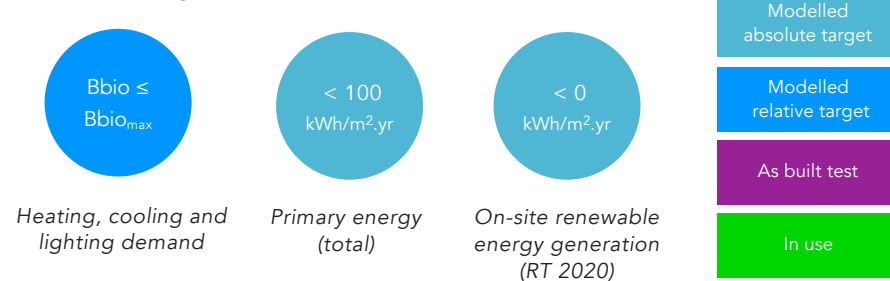

Further Requirements

In- use energy disclosure	No (tbc)
Proven track record against actual in-use performance	Limited available data
Any as built tests required	Airtightness test per dwelling
Other Requirements (e.g. for regular inspection of heating and AC system)	None
Performance or prescriptive	Performance with prescriptive airtightness requirements
Limiting parameters	None (except airtightness) – balancing one parameter with another is possible

Main differences with SAP

Metrics	Relative target for heating, cooling and lighting demand. Absolute target for heating energy use. Absolute target for total energy use in primary energy.
Thermal envelope approach	Airtightness limit and heating, cooling & lighting demand drive attention to envelope
Heating, hot water and ventilation system	Detailed input
Treatment of unheated spaces e.g. corridors	All areas with the thermal envelope are included.
Solar gains	Calculated in detail
Internal gains	Some standardised assumptions (e.g. IT), but occupancy can be a specific input (tbc).
Philosophical approach to achieving accuracy	Maximum demand not to exceed for total of heating, cooling and lighting demand, and total primary energy. Within these, design flexibility is possible.
Validation	-
Thermal Bridges	Thermal bridges are calculated and taken into account
Ventilation system	Systems are modelled. The design of the system as a whole including ducting system and insulation is taken into account.
Measurement of air infiltration	Air permeability in m ³ /m ² h @ 4 Pa.
Shading	Detailed inputs on depths of window reveal per window and shading factor input per window for summer and window shading. Shading from external elements can also be accounted for.

Building Energy Models | In-depth review: France RT

Calculation process

Modelling method categorisation	Steady state - Monthly or annual degree day model
Time required for inputs	Similar to SAP
Training and accreditation schemes/requirements for the modeller	Formal user training requirement to sign off calculations.
Level of complexity	Medium to high
Which ISO does it use	
Calculation by apartment or by building	The whole building is modelled and then zoned into different apartments.
Heating demand calculation	Total heat loss minus all incidental gains, calculated using hourly steps.
Standard assumptions	Location/altitude Profiles for DHW, heating, lighting, cooling ventilation Lighting controls
Bespoke assumptions	Occupancy matches the actual project. Systems are the actual ones (ventilation, lighting etc).







Futureproofing

Does it address any other building performance aspects	Overheating calculations are included through the Tic < Ticref requirement. The hottest temperature reached during a sequence of five very hot summer days, must not exceed a threshold.
Treatment of emerging trends e.g. peak demand, demand management, electric vehicles charging	No
Ability to respond to key policy, market and technology trends tests	Use of more efficient technologies and renewable energy systems are encouraged.

Inputs

Weather file	Different weather data are being used depending on climatic region. They also impact on the target.
Building Geometry	Heat loss surface area including window glazing areas Internal floor area and volume Thermal bridge lengths
Building Fabric Parameters	Element U-values (glazing and frame separately for windows) Building thermal mass Airtightness Thermal bridge psi-values and Xi-values Glazing g-values Window overshadowing (detailed inputs)
Building Service Parameters	Heating: Detailed data of efficiency of systems, heating pipe length, temperatures and insulation thickness and thermal conductivity Hot water: hot water cylinder size and heat loss rate, hot water pipe length, temperatures and insulation thickness and thermal conductivity, number of tapping points Ventilation: supply and extract rates, heat recovery efficiency, electric efficiency, efficiencies (taking account of duct length and shape) and insulation properties Lighting: average lamp efficiency (lm/W) Auxiliary: pump power specified
PV	Area, orientation, inclination, kWp output and inverter efficiency
Complexity for inputting heating and hot water system	Heating and hot water systems are modelled in detail
Complexity for inputting ventilation systems	Ventilation systems are modelled in detail
Complexity for inputting Thermal Bridges	Thermal bridges are modelled in detail

Building Energy Models | In-depth review: Existing Homes: Methodologies building on SAP/RdSAP

Modifications to SAP/RdSAP or its inputs: ▼	 Green Deal assessment	 Parity - vWhole house plan	 Carbon Co-op  urbed  Carbon Coop & Urbed  My Retrofit Planner
Overview	Used to inform Green Deal works and financing, not for EPC / SAP ratings	Similar adjustments to Green Deal assessment; Used to inform retrofit works and the evaluation of “realistic fuel bills”, not for EPC / SAP ratings	Used to inform retrofit works, not for EPC / SAP ratings
Basis of methodology	RdSAP 2012 version 9.92, modified with Green Deal Occupancy Assessment	RdSAP 2012, modified	SAP 2012, modified
Track record against in-use performance?	n/a	n/a	Some evidence on a small sample (Heaslip, 2017); evidence on larger sample may become available
Uses building survey?	Typically not: data from existing EPC and RdSAP default values	Yes	Yes
Uses occupancy survey?	Yes, using Green Deal occupancy assessment	Yes	Yes
Target setting	None	Client-specific; variety of options e.g. energy, costs or carbon savings, SAP ratings	Space heating demand, including “first measures” and “how low can you go”; ranges for peak heating load; possibly EUI in the future
Climate	Actual location (SAP regional zone)	Actual location (SAP regional zone)	Actual location (SAP regional zone)
Number of occupants	Actual	Actual	Actual
Heating setpoint and patterns	Actual	Actual	Actual setpoint, if above 20°C; 20°C if actual setpoint is below, to allow some “comfort take-back”. Actual patterns if available
Hot water	Actual fittings (shower and baths) Actual patterns e.g. number of showers per day	Actual appliances, if available and deemed influential	tbc
Fabric performance: U-values, airtightness	Standard RdSAP assumptions	Standard RdSAP assumptions	Measured values if available
Unregulated loads	Actual white goods and cooker	Actual white goods, if deemed influential	Actual white goods and appliances
Informed by actual energy use?	Yes, if available	tbc	Yes: pre- and, if possible, post-works
Other comments	Initially included in-use factors to reduce the calculated energy savings (DECC, 2012); later removed following consultation (BEIS, 2018) Other adjustments e.g. lighting, secondary heating	Other adjustments e.g. lighting, if deemed influential; SAP10 carbon factors; individual windows, to represent dimensions and allow different performance values across the home	Modified heat loss from chimneys and flues; Accounts for previous works, even without robust evidence, to avoid over-estimating savings; Considers overheating and others issues outside of SAP e.g. moisture, ventilation, user survey

Ecosystems around Energy Models | CaGBC- Zero Carbon Building – Design Standard

Summary

Energy model	CaGBC- Zero Carbon Building Design Standard
Purpose	Designing to a zero carbon standard
Use type	All new buildings except single and multi-family residential buildings that are less than 3 stories and smaller than 600m ²
Location	Canada
Scope	Regulated and unregulated energy
Simulation tool	Many including eQuest and Energy Plus, with results entered into NZC-V2 workbook

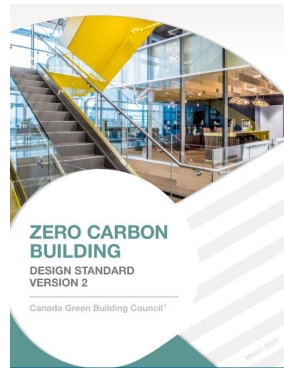

Energy Metrics

Option 1: (Flexible Approach) TEDI of 30-40 kWh/m²/year and Site EUI of 25% better than National Energy code for buildings (NECB)2017

Option 2: (Passive Design Approach) Thermal energy demand intensity (TEDI) of 20-30 kWh/m²/year, as a function of climate zone

Option 3: (Renewable Energy Approach): Thermal energy demand intensity (TEDI) of 30-40 kWh/m² /year, as a function of climate zone; and Zero carbon balance for operational carbon achieved without green power products or carbon offsets

Other metrics

In addition to the above building must achieve the following;

ZCB-Design v2 One-time certification for new buildings and major renovations		
Carbon	Zero carbon balance	Model zero carbon balance
	Embodied carbon	Report embodied carbon
	Refrigerants	Report total quantity
	RECs and carbon offsets	Provide quote
	Onsite combustion	Provide transition plan
Energy	Energy efficiency	Meet one of three approaches
	Peak demand	Report seasonal peaks
	Airtightness	Report and justify modelled value
Impact and Innovation		Apply two strategies

Energy modelling software

The energy modelling software or simulation program shall be tested according to A SHRAE Standard 140 (except sections 7 and 8). This includes, but is not limited to DOE-2 based modelling programs (eQuest, CanQUEST, Energy Pro, Visual DOE), IES, HAP, TRACE, EnergyGauge, and Energy Plus.

Software limitations shall not excuse the limitation of accuracy of energy modelling to show compliance with the standard; consultants are expected to overcome any software limitations with appropriate engineering calculations. All other modelling inputs not discussed in these guidelines shall follow accepted industry best practice.

Zero carbon balance

A carbon balance of zero or better over a 60-year life-cycle must be demonstrated for ZCB-Design certification. The zero carbon balance includes embodied carbon and emissions from refrigerant leakage. The carbon balance is the net emissions that result from sources and sinks of carbon emissions, calculated as follows.

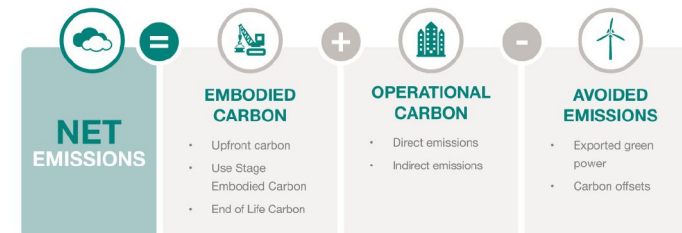

Ecosystems around Energy Models | CaGBC- Zero Carbon Building – Design Standard

Embodied carbon

Applicants must provide an embodied carbon report demonstrating that the requirements outlined below have been met. The ZCB v2 Embodied Carbon Reporting Template may be used for this purpose.

After minimizing embodied carbon emissions during design and construction, projects that achieved ZCB-Design v2 will be required to offset their embodied carbon to achieve ZCB-Performance certification. As outlined in the ZCB-Performance Standard, projects may choose to mitigate embodied carbon by offsetting equal amounts annually over as many as five years. Beyond the life-cycle carbon (life-cycle stage D) is not included in embodied carbon and does not need to be offset when seeking ZCB-Performance certification.

Refrigerants

ZCB-Design certification requires projects to report the total quantity, type, and GWP of each refrigerant contained in all base building HVAC systems with a capacity of 19 kW (5.4 tons) or greater. This is consistent with the Federal Halocarbon Regulations (2003) that regulate all federal government buildings in Canada. Reporting the GWP will enable project teams to understand the implications of an accidental refrigerant leak.

Peak demand

Projects pursuing certification under the ZCB-Design Standard are required to report their anticipated summer and winter seasonal peak demand (or 'peak power'). Peak demand must represent the highest winter and summer electrical load requirements on the grid, reflecting any peak-shaving impacts from demand management strategies, including onsite power generation or energy storage. Peak demand must be reported in kilowatts (kW).

Workbook

An excel based workbook must be completed that summarised the results of the operational energy and embodied carbon modelling. This includes hourly electricity use and seasonal peak demand.

Zero Carbon Building - Design v2 Workbook Summary

PROJECT INFORMATION

ZCB Project Number: [Redacted]
 Project Name: [Redacted]
 Address: [Redacted]
 City: [Redacted]
 Province: [Redacted]
 Climate Zone: [Redacted]
 Building Use: [Redacted]
 Floor Count (below grade): [Redacted]
 Floor Count (above grade): [Redacted]
 Gross Floor Area: [Redacted] m²
 Modified Floor Area: [Redacted] m²
 Building Footprint: [Redacted] m²

→ Applicants to input data in grey cells

CARBON & ENERGY COMPLIANCE

Carbon Requirements
 Net Emissions = Embodied Emissions + Operational Emissions - Avoided Emissions
 Carbon balance over 60 years: [Redacted] t/kWh CO₂e

Energy Efficiency Requirements

Option 1: [Redacted] Flexible approach: [Redacted]
 Option 2: [Redacted] Passive design approach: [Redacted]
 Option 3: [Redacted] Renewable energy approach: [Redacted]

Energy Efficiency

Thermal energy demand intensity (TED): [Redacted] kWh/m²/yr
 Energy use intensity (EUI): [Redacted] kWh/m²/yr
 Site EUI improvement over NECB 2017*: [Redacted] %
 Summer peak demand: [Redacted] kW
 Winter peak demand: [Redacted] kW

Carbon Reduction Measures

Biomass: [Redacted] kWh/yr
 Owned renewable energy: electricity: [Redacted] kWh/yr
 Owned renewable energy: solar thermal: [Redacted] kWh/yr
 Green power: products: [Redacted] kWh/yr
 Exported green power: [Redacted] kWh/yr
 Carbon offsets: [Redacted] kg CO₂e

Zero Carbon Building - Design v2 Workbook Electricity

Carbon Emissions from Electricity

Grid Electricity Used: [Redacted] kWh
 Less: Green Power Products: [Redacted] kWh
Electricity Contributing to Emissions: [Redacted] kWh

Emissions from Electricity: [Redacted] kg CO₂e
 Less: Avoided Emissions from Exported Green Pow.: [Redacted] kg CO₂e
Electricity Carbon Balance: [Redacted] kg CO₂e

Avoided Emissions Factor Used: [Redacted] Average Factor

Seasonal Peak Demand
 (Derived from hourly Grid Electricity Used)

	Winter	Summer
Peak Demand	0 kW	0 kW
Date and Time	01/01/2019 12:00:00 AM	06/01/2019 12:00:00 AM

Electricity Use Summary

Month	Electricity Used (kWh)	Green Power Generated (kWh)	Green Power Used (kWh)	Grid Electricity Used (kWh)	Exported Green Power (kWh)
January	0.0	0.0	0.0	0.0	0.0
February	0.0	0.0	0.0	0.0	0.0
March	0.0	0.0	0.0	0.0	0.0
April	0.0	0.0	0.0	0.0	0.0
May	0.0	0.0	0.0	0.0	0.0
June	0.0	0.0	0.0	0.0	0.0
July	0.0	0.0	0.0	0.0	0.0
August	0.0	0.0	0.0	0.0	0.0
September	0.0	0.0	0.0	0.0	0.0
October	0.0	0.0	0.0	0.0	0.0
November	0.0	0.0	0.0	0.0	0.0
December	0.0	0.0	0.0	0.0	0.0
Total	0.0	0.0	0.0	0.0	0.0

Hourly Site Electricity Data

Date	Time	Electricity Used (kWh)	Green Power Generated (kWh)	Green Power Used (kWh)	Grid Electricity Used (kWh)	Exported Green Power (kWh)
Total		0.0	0.0	0.0	0.0	0.0
01-Jan	00:00					
01-Jan	01:00					
01-Jan	02:00					
01-Jan	03:00					
01-Jan	04:00					
01-Jan	05:00					
01-Jan	06:00					
01-Jan	07:00					
01-Jan	08:00					
01-Jan	09:00					
01-Jan	10:00					
01-Jan	11:00					
01-Jan	12:00					
01-Jan	13:00					
01-Jan	14:00					
01-Jan	15:00					
01-Jan	16:00					
01-Jan	17:00					
01-Jan	18:00					
01-Jan	19:00					
01-Jan	20:00					
01-Jan	21:00					
01-Jan	22:00					
01-Jan	23:00					
02-Jan	00:00					
02-Jan	01:00					
02-Jan	02:00					
02-Jan	03:00					
02-Jan	04:00					
02-Jan	05:00					
02-Jan	06:00					
02-Jan	07:00					
02-Jan	08:00					
02-Jan	09:00					
02-Jan	10:00					
02-Jan	11:00					
02-Jan	12:00					
02-Jan	13:00					
02-Jan	14:00					
02-Jan	15:00					

Ecosystems around Energy Models | CaGBC- Zero Carbon Building – Performance Standard

Summary

Energy model	CaGBC- Zero Carbon Building performance Standard
Purpose	Verifying zero carbon operations of existing buildings.
Use type	All new buildings except single and multi-family residential buildings that are less than 3 stories and smaller than 600m ²
Location	Canada
Scope	Regulated and unregulated energy
Simulation tool	None- based on in-use data-performance standard workbook must be completed

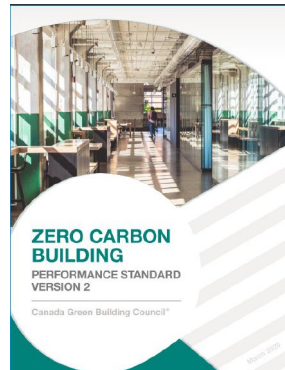

Metrics

ZCB-Performance v2 Annual certification for existing buildings		
Carbon	Zero carbon balance	Achieve zero carbon balance
	Embodied carbon	Offset embodied carbon
	Refrigerants	Offset any leaks
	RECs and carbon offsets	Provide proof of purchase
	Onsite combustion	Update plan every 5 years
Energy	Energy efficiency	Report EUI
	Peak demand	Report seasonal peaks
	Airtightness	Conduct testing if ZCB-Design v2 certified
Impact and Innovation		No requirement

Zero carbon balance

The Zero Carbon Building – Performance Standard provides an annual verification of the achievement of zero carbon operations, recognizing that the holistic assessment of carbon emissions is the best measure of progress towards minimizing climate change impacts from buildings.

EUI

Applicants must report the total site EUI of the building in kWh/m²/year. Reporting EUI enables building operators to gauge the effectiveness of energy conservation measures and demonstrate progress over time. It also enables industry to learn from each zero-carbon building.

EUI targets have not been set for operational performance, to recognize the wide range in performance of existing buildings and to encourage the highest number of buildings to achieve zero carbon. Projects undergoing major retrofits to improve energy performance should consider ZCB-Design certification, which features energy performance targets.

Embodied Carbon

For Projects previously certified ZCB-Design v2: Must offset the embodied carbon from the initial construction or retrofit, as reported in the embodied carbon report that was submitted for ZCB-Design v2

All projects: Must offset any embodied carbon of new structural and envelope materials used in a retrofit completed in the year being evaluated for the ZCB-Performance certification. Embodied carbon must be determined by conducting a life-cycle assessment

Refrigerants

ZCB-Performance projects must report the total quantity, type, and GWP of each refrigerant contained in all base building HVAC systems with a capacity of 19 kW (5.4 tons) or greater. This is consistent with the Federal Halocarbon Regulations (2003) that regulate all federal government buildings in Canada.

Projects must report any corrective actions taken to address refrigerant leaks and the volume of refrigerants used to recharge systems in the year being evaluated for the ZCB-Performance certification. The recharged refrigerant volume must be included in the carbon balance and, therefore, be offset. Emission factors for refrigerants are sourced from the most recent release of Canada’s National Inventory Report.

Peak demand

Applicants for certification under the ZCB-Performance Standard are required to report their summer and winter seasonal peak demand (or ‘peak power’). Peak demand must represent the highest winter and summer electrical load requirements on the grid, reflecting any peak-shaving impacts from demand management strategies including onsite power generation or energy storage. Peak demand must be reported in kilowatts (kW).

Ecosystems around Energy Models | British Columbia Step Code

The BC step code governs minimum policy for new build in British Columbia. Different cities have different minimum compliant, this is between code 1- code 3. Voluntary standards then use the same framework but mandate higher steps (levels).

In some cities developers are permitted to have larger building or higher density that standard policy if they are achieving higher 'steps'

Methods

There are two modelling methods associated with the step code for residential buildings

1. For residential buildings with 3 stories or less and under 600m² a simple steady state model is used to show compliance (Part 9) using the Energuide for homes method. A common simulation tool that is used is HOT 2000 - **an in-depth review for this scenario has been carried out in this report**
2. For residential building larger than 3 storeys (Part 3) an Ashrae NECB model is developed, using a Dynamic simulation model such as IESVE or EQuest

Targets

Level 1 is just the energy guide rating – this is a comparative energy use metric

From step 2 onwards there are three requirement – with tighter targets per step

- airtightness requirements,
- an energy metric (either a comparative energy use metric (TEUI) or an absolute mechanical use intensity (MEUI) – which is essentially heating, hot water and ventilation consumption
- An absolute thermal energy metric or a relative thermal energy demand metric

The energy and space heating targets depends on the climatic region- which are based on degree days- there are 6 regions.

The MEUI target is based on the proportion of the conditioned space is cooled and the area of the building.



Step	Airtightness (Air Changes per Hour at 50 Pa Pressure Differential)	Performance Requirement of Building Equipment and Systems	Performance Requirement of Building Envelope
1	N/A	EnerGuide Rating % lower than EnerGuide Reference House: not less than 0% lower energy consumption or conform to Subsection 9.36.5.	
2	≤ 3.0	EnerGuide Rating % lower than EnerGuide Reference House: not less than 10% lower energy consumption or the applicable mechanical energy use intensity requirements in Table 9.36.6.3-G	thermal energy demand intensity ≤ 35 kWh/(m ² ·year), thermal energy demand intensity not exceeding the value calculated in accordance with Sentence (4), or not less than 5% performance improvement over the EnerGuide Reference House
3	≤ 2.5	EnerGuide Rating % lower than EnerGuide Reference House: not less than 20% lower energy consumption or the applicable mechanical energy use intensity requirements in Table 9.36.6.3-G	thermal energy demand intensity ≤ 30 kWh/(m ² ·year), thermal energy demand intensity not exceeding the value calculated in accordance with Sentence (4), or not less than 10% performance improvement over the EnerGuide Reference House
4	≤ 1.5	EnerGuide Rating % lower than EnerGuide Reference House: not less than 40% lower energy consumption or the applicable mechanical energy use intensity requirements in Table 9.36.6.3-G	thermal energy demand intensity ≤ 20 kWh/(m ² ·year), thermal energy demand intensity not exceeding the value calculated in accordance with Sentence (4), or not less than 20% performance improvement over the EnerGuide Reference House
5	≤ 1.0	the applicable mechanical energy use intensity requirements in Table 9.36.6.3-G	thermal energy demand intensity ≤ 15 kWh/(m ² ·year), thermal energy demand intensity not exceeding the value calculated in accordance with Sentence (4), or not less than 50% performance improvement over the EnerGuide Reference House

Requirements of each 'Step' for residential buildings with 3 stories or less for a specific climatic region (locations that have less then 3000 degree-days.)

Ecosystems around Energy Models | Toronto - Zero Emissions Buildings framework

Summary

Energy model	Toronto - Zero Emissions Buildings framework
Purpose	Regulation: to take the building industry to a near-zero emissions level of performance by 2030
Use type	Domestic and non domestic new buildings and major renovations if over 1000m ²
Location	Canada
Scope	Regulated and unregulated energy
Simulation tool	Many including eQuest, Energy Pro, Energy Plus



The framework comprises a full set of targets for the five most common building archetypes that require increasing levels of performance over time. This pathway to near-zero emissions building construction intends to help the City meet its 2050 GHG reduction goals, and provides the building industry with a clear and transparent picture of future requirements. The emphasis on total energy use, thermal demand reduction and greenhouse house gas emissions encourages a passive design-first approach coupled with high efficiency active systems, such as heat recovery, and improved air tightness

Calculation process

Modelling Method	As per the Toronto - Zero Emissions Buildings framework energy modelling guidelines
Modelling method categorisation	Dynamic simulation
Time required for inputs	Slow
Training and accreditation schemes/requirements for the modeller	
Level of complexity	High

Further requirements

In-use energy disclosure	Mandatory disclosure
Proven track record against actual in-use performance	yes
Compliance basis	Based on modelled information

Energy Metrics

Total Energy Use Intensity: to encourage higher efficiency buildings and lower utility costs;

Thermal Energy Demand Intensity (TEDI): to encourage better building envelopes, improve occupant comfort and enhance resilience

GHG Intensity: to encourage low-carbon fuel choices and reduce building emissions.

Other Requirements

Renewables energy generation: Buildings designed to either accommodate connection to solar technologies, or to supply their total energy load with 5% from renewable energy sources or 20% with geexchange

District Energy connection: Buildings designed to enable connection or actually connect to a district energy system (where one exists or is slated for development)

Air tightness testing requirements: Requiring buildings to conduct whole building air tightness testing helps to improve the quality and airtightness of the building envelope, as well as the performance gap between building design and performance.

Commissioning requirements: Fundamental commissioning and enhanced commissioning requirements help to ensure that buildings are constructed and operated properly, improving overall building energy performance.

Submetering: Submeters installed by floor/defined use or by appliance/tenant will help to give a clear picture of building energy use.

Labelling and disclosure: Requirements for buildings to annually report their energy consumption aligns with Provincial requirements, while naming the City of Toronto ensures the City can track and help to improve buildings' energy performance over time.

Energy Use Disclosure

From 2018, building owners are required to report building energy (and water) consumption on a yearly basis using ENERGY STAR® Portfolio Manager (large commercial and multi-residential buildings (i.e. over 50,000 square feet.

Development of targets

Ratchetting building energy performance targets were developed for each metric for five new building archetypes, including high-rise multi unit residential building (MURB), Residential mixed use (i.e. ground floor retail with residential tower above); Low rise MURB (i.e. 4-6 storey wood frame); Commercial office; Large format retail.

Building Archetype	Scenario	Proposed Annual Targets*		
		EUI (kWh/m ²)	TEDI (kWh/m ²)	GHG (kg/m ²)
High Rise MURB 30 Storeys, 243,890 ft ² , 4 pipe H/C system with central plant, MUA ventilation for corridors, HRV/ERV for suites	TGS v2 T1 (SB-10 2017)	190	77	26
	TGS v2 T2	170	70	20
	TGS v3 T1	170	70	20
	TGS v3 T2	135	50	15
	TGS v3 T3	100	30	10
	TGS v3 T4	75	15	5

For other archetypes specific targets may be developed over time; in the interim, a 'percent better than' approach can be used. This recommendation aligns with the current TGS (v2).

- FOR TIER 1, a target of 15% better than current requirements
- FOR TIER 2, a target of 25% better than current requirements.

Building resilience

Developments at higher Tiers, have greater resilience to power outage, the table below shows that after 72 hours of a power outage under winter conditions a Tier 1 home would have an internal temperature of 9.9 °C whereas a Tier 4 home would have an internal temperature of 19.7 °C.

Table 4: Resilience of Tiers 1-4 for High-Rise MURB

Tier	% Energy Savings over SB-10	Peak Power (W/m ²)	72h Power Off Winter Temp. Low (°C)	2 Week Power Off Winter Temp. Low (°C)	Emergency Fuel Factor (x baseline)
TGS v2 T1 (SB-10 2017)	N/A	11.1	9.9	0.9	1.0
TGS v2 T2	11%	9.7	13.5	5.8	1.2
TGS v3 T1	11%	9.6	13.5	5.8	1.3
TGS v3 T2	29%	9.6	14.6	7.6	1.4
TGS v3 T3	47%	11.0	17.0	14.0	1.5
TGS v3 T4	61%	11.5	19.7	18.3	1.8

Energy modelling guidelines

The City of Toronto's Energy Modelling Guidelines provide standardized inputs and software requirements for the as-designed and as-constructed energy modelling reports required for Tier 1 and 2. Energy modelling guidelines provide information on Definitions and calculations for TEUI, TEDI, and GHGI;

- SB-10 emissions factors for calculating GHGI;
- How on-site renewable energy and district energy connection can help to meet targets;
- Acceptable energy modelling software;
- Standardized inputs for occupancy and other schedules, domestic hot water, process loads, and infiltration;
- Specific component requirements, e.g. heat recovery ventilators;
- Accounting for envelope heat loss, including thermal bridging;
- Considerations for mixed use buildings.

Resilience checklist

In lieu of specific resilience requirements, the City of Toronto has opted for a checklist approach to encourage building design teams to consider the key impacts of climate change on their design and incorporate measures to improve building safety and occupant comfort during extreme events, to encourage the construction of safe and resilient buildings that are able to withstand expected changes in climate. The checklist covers the following areas:

- Energy performance, including modelled TEUI, TEDI, and peak energy demand intensity;
- Modelling assumptions e.g. temperature minimums/maximums, extreme heat events, and flooding events;
- Thermal resilience and safety measures, to reduce the impact of heat waves;
- Back-up generation capacity, and measures to reduce reliance on the grid;
- Flood mitigation, including measures to reduce the impact of heavy rainfall events;
- Manager and tenant preparedness measures during extreme events.

Ecosystems around Energy Models | Toronto - Zero Emissions Buildings framework

Why they didn't include a peak energy demand metric

While a peak energy demand metric was also considered for inclusion, it was later excluded as a result of its high sensitivity to differences in energy modelling software. The use of one type of energy modelling software over another would have therefore created significant differences in the ease with which the target would have been generated.

Incentives

The City of Toronto offers a significant Development Charge (DC) refund to third party certified Tier 2 developments. The incentive covers a substantial portion of the premium for energy efficiency measures in construction. However, the new targets and additional performance tiers that make up the Zero Emissions Buildings Framework warrant an investigation into additional means of supporting those that pursue the higher Tiers 3 and 4. At present, the support that the DC Refund provides to different building types and tiers varies considerably, depending on the development charges paid. For example, some forms of development have reduced Development Charges or are exempt from charges altogether as another form of incentive. High-Rise MURB developments that pay the largest Development Charges benefit the most from the refund, whereas non-residential and commercial buildings that only pay Development Charges for the first above-grade storey receive less of a financial incentive from the Refund.

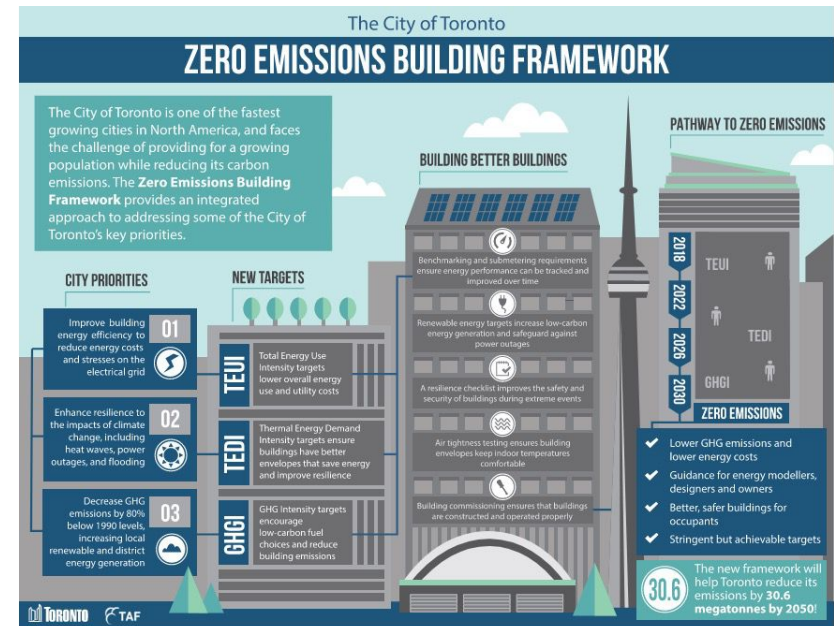

Ecosystems around Energy Models | Vancouver Zero Emissions Building Plan

Building in Vancouver are required to meet following requirements of either:

- A. Near Zero Emissions Buildings, or
- B. Low Emissions Green Buildings.

A. Near Zero Emissions Buildings

(1) Near Zero Emissions Building Standard Projects shall be designed to meet **Passive House requirements** and apply for certification, or to an alternate near zero emissions building standard, such as the **International Living Future Institute’s Zero Energy Building Certification**, as deemed suitable by the Director of Sustainability.

AND

(2) **Energy System Sub-Metering and Reporting** Projects shall meet the requirements for Energy System Sub-Metering and Reporting.

AND

(3) **Low-Emitting Materials** Projects shall be designed to minimize emissions from interior materials containing volatile organic compounds (VOCs) or added urea formaldehyde.

B. Low Emissions Green Buildings

There are 11 requirements, which are summarised below and aside.

Performance Limits: All buildings shall meet or exceed performance limits according to their building type summarized in the tables below, as modelled according to the City of Vancouver Energy Modelling Guidelines. The Energy Modelling Guidelines set standard assumptions and requirements for energy models when assessing compliance with the limits, including accounting for thermal bridging, consideration of summertime thermal comfort, and the treatment of mixed-use buildings.

Refrigerant Emissions and Embodied Emissions: All projects shall calculate and report the life-cycle equivalent annual carbon dioxide emissions of each building, in kgCO₂e/m², from the emission of refrigerants. This requirement does not apply to projects where the total installed heating and cooling capacity of equipment containing refrigerants is less than 35kW.

Other requirements include: All commercial building to achieve LEED Gold - Building Design and Construction, enhanced commissioning, energy system sub-metering and reporting, verified direct ventilation, low-emitting materials, indoor air quality testing, integrated rainwater management and green infrastructure.

Performance Limits Buildings Not Connected to a City-recognized Low Carbon Energy System			
Building Type	TEUI (kWh/m ²)	TEDI (kWh/m ²)	GHGI (kgCO ₂ /m ²)
Residential Low-Rise (< 7 storeys)	100	15	5
Residential High-Rise (7+ storeys)	120	30	6
Office	100	27	3
Retail	170	21	3
Hotel	170	25	8
All Other Buildings	EUI 35% better than Building By-law energy efficiency requirements, Section 10.2, in effect at the time of rezoning application		

Performance Limits Buildings Connected to a City-recognized Low Carbon Energy System			
Building Type	TEUI (kWh/m ²)	TEDI (kWh/m ²)	GHGI (kgCO ₂ /m ²)
Residential Low-Rise (< 7 storeys)	110	25	5
Residential High-Rise (7+ storeys)	130	40	6
Office	110	27	3
Retail	170	21	3
Hotel	170	25	8
All Other Buildings	EUI 35% better than Building By-law energy efficiency requirements, Section 10.2, in effect at the time of rezoning application		

TEUI: Total Energy Use Intensity
 TEDI: Thermal Energy Demand Intensity
 GHGI: Greenhouse Gas Intensity

Alternate Compliance Pathway for Energy and GHG Reductions: In lieu of compliance with the GHGI limits required by the table above, Residential High-Rises (7+ storeys) and Hotels may achieve a TEUI of 100 and 120 respectively, and a TEDI of 15. In addition, any building type seeking an alternative compliance path may use A.1, Near Zero Emissions Building Standard.

Small residential buildings: for Part 9, in lieu of the TEUI and TEDI limits required by this policy, projects may meet an alternate set of performance or prescriptive requirements, such as an equivalent step of the Part 9 BC Energy Step Code, as deemed acceptable by the Director of Sustainability

Ecosystems around Energy Models | Washington DC – Appendix Z

Summary

Energy model	Clean Energy DC – Appendix Z
Purpose	A voluntary, performance-based code compliance pathway for buildings in North America
Use type	Domestic and non domestic new buildings
Location	Washington, DC, USA
Scope	Regulated and unregulated energy
Simulation tool	Range of tools including IESVE, Energy plus, EQuest

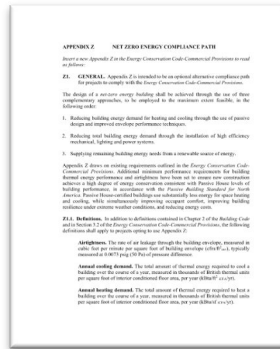

Appendix Z is a first step for the District Government towards codifying how to qualify a building as Net Zero. It is the first voluntary, performance-based code compliance pathway for buildings in North America, and has been included into the 2018 DC code. It defines a net-zero energy building as a highly energy efficient building that produces on-site or procures, through the construction of new renewable energy generation, enough energy to meet or exceed the annual energy consumption of its operations.

Calculation process

Modelling Method	Appendix G ASHRAE 90.1-2016
Modelling method categorisation	Dynamic simulation
Time required for inputs	Slow
Training and accreditation schemes/requirements for the modeller	It's new standard no training schemes yet
Level of complexity	High

Further requirements

In-use energy disclosure	Mandatory disclosure
Proven track record against actual in-use performance	Not yet – it is a new standard
Compliance basis	When this is used as a compliance path, then the compliance based is based on 12 months of energy consumption

Energy Metrics

EUI: A comparative EUI metric (zEPI of 40 or lower) a calculation that is based on Appendix G ASHRAE 90.1-2016 model with a baseline model and an proposed model). Modelling profiles updated to expected occupancies.

Annual heating demand absolute target

Annual cooling demand absolute target

No onsite combustion for the provision of thermal energy

Renewable energy requirements: It is stated that The building and building site shall be provided with renewable energy equal to the EUIP on an annual basis, 5% of the total consumption has to be met by solar energy, and then the remainder is met by;

- Further on site renewables (Acceptable renewables on site include PV, solar thermal, wind turbines or biogas)
- A PPA for a minimum of 10 years for a new solar energy installation located within DC or in locations with transmission and distribution lines serving the District of Columbia.
- Connection to a renewable energy microgrid;
- Connection to a low-carbon neighbourhood thermal energy system.

Energy Use Disclosure and verification

When Appendix Z is used as a code compliance path, then the owners must annually benchmark and report their energy and water performance using the Energy Star® Portfolio Manager tool, including renewable energy generation and green power usage.

You do not need to prove through energy metered data that the building is meeting the EUI, but do need to prove that the energy consumed by the building is equal or less than the renewable energy associated with the building.

Prescriptive requirements

In addition to the requirements above there are certain prescriptive requirements that include; performance and thermal envelope tightness limits; a registered design professional who shall act as the registered design professional in responsible charge of building energy simulation;

Commissioning requirements and As built airtightness testing.

Summary

Energy model	Seattle energy code- target performance path
Purpose	Regulation in Seattle
Use type	Domestic and non domestic new buildings
Location	Seattle, DC, USA
Scope	Regulated and unregulated energy
Simulation tool	Range of tools including IESVE, Energy plus



In Seattle there are three routes to compliance;

1. A prescriptive path
2. A total building performance path
3. A target performance path: this has fewer mandatory requirements than route 2, and uses energy modelling to demonstrate that the proposed design is capable of meeting the operational performance target; in addition this path requires that the actual measured building energy consumption to meet the target.

Calculation process

Modelling Method	Washington state code
Modelling method categorisation	Dynamic simulation
Time required for inputs	Slow
Training and accreditation schemes/requirements for the modeller	High
Level of complexity	High

Further requirements

In-use energy disclosure	Mandatory disclosure within 3 years of building occupancy- there is a financial penalty if the target is not met, 50% of which can be reinvested into improvements to the building.
Proven track record against actual in-use performance	Yes
Compliance basis	Based on in-use information

Metrics

EUI: An absolute EUI target that varies per building type. **based on building type.** The target performance path allows for a 13% uplift in EUI target compared to the total building performance path. With the new, 2018 version of the Energy Code (not yet in effect, but will be starting March 2021) they are changing both compliance paths and using Building Performance Factor (BPF) for both paths, an uplift is still applied to the target performance path.

Energy modelling methodology

Schedules, internal loads and other assumptions related to the operation of the building are permitted to be developed at the discretion of the design team and the energy modeler, deviations from standard assumptions must be clearly documented.

Documentation also needs to be provided on sensitivity analysis of principal internal load and other building operational assumptions that demonstrate a range of expected energy performance in the context of typical meteorological year (TMY) conditions. The following sensitivity analyses shall be reported, in tabular format:

- 2.1. Occupant density +/- 20 percent (except residential occupancies)
- 2.2. Lighting Power Density +/- 20 percent
- 2.3. Miscellaneous Load Power Density +/- 20 percent
- 2.4. Infiltration Rates +/- 20 percent
- 2.5. Temperature Setpoints +/- 2 degrees F

Energy modeler qualifications

Energy models can only be created only by persons qualified and who have at least two years' experience modelling buildings of similar scale and complexity. The modelling documentation submitted is to be signed either by a licensed professional engineer who is qualified by training and experience to perform energy modelling or by an individual with an active certification from ASHRAE as a Building Energy Modelling Professional (BEMP)

Demonstration of operating energy use.

Metered energy data is supplied directly via automated reporting from utilities to the code official using Portfolio Manager, and adjusted for the percentage of the conditioned floor area intended for occupancy that is occupied during the recording period.

Ecosystems around Energy Models | City of Boulder energy conservation code (COBECC)

Summary

Energy model	City of boulder energy conservation code
Purpose	Regulates mini-mum energy conservation requirements for new buildings.
Use type	Domestic and non domestic
Location	Boulder, CO, USA
Scope	Regulated and unregulated energy
Simulation tool	Range of tools including IESVE, Energy plus

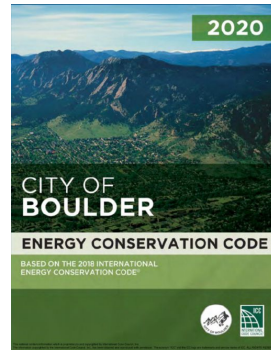

2020 City of Boulder Residential Energy Code Pathways

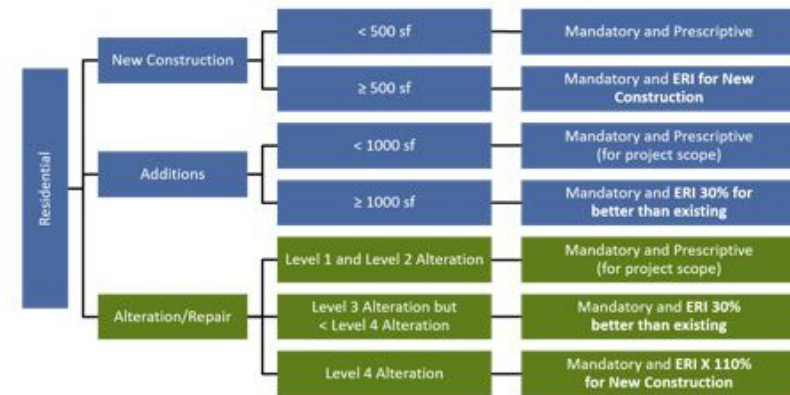

Separate requirements for:

1. Residential buildings greater than three stories in height above grade (commercial buildings also have to meet this requirement)
2. Detached one and two-family dwelling and multiple single-family dwellings less than three stories in high

Calculation process

Modelling Method	A modified version of Appendix G of ASHRAE 90.1-2016 according to the Boulder Modified Appendix G Protocol with modified building performance factors
Modelling method categorisation	Dynamic simulation
Time required for inputs	Slow
Training and accreditation schemes/requirements for the modeller	
Level of complexity	High

Further requirements

In-use energy disclosure	Mandatory disclosure
Proven track record against actual in-use performance	Yes
Compliance basis	Based on modelled information

2020 City of Boulder Commercial Energy Code Pathways

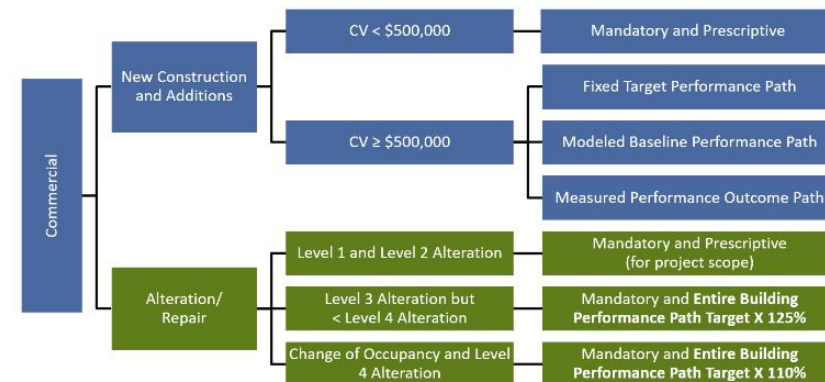

Residential buildings greater than three stories in height above grade (commercial buildings also have to meet this requirement)

Option 1: Modelled baseline performance path

Projects shall comply with Section 4.2.1.1 of ASHRAE Standard 90.1-20

Option 2: Fixed target performance path

EUI targets must be met for mid-rise apartments a EUI of no greater than 32 kBtu/ft This is shown through energy modelling which must use schedules provided in the "Boulder Modified Appendix G Protocol.

Projects using the performance path are required to submit an analysis comparing design modelling to actual energy use for a consecutive 12-month period within two years of project occupancy. This analysis should use billing data and sub-metered data from the building to identify the accuracy of the energy model and any areas of performance divergence from predicted energy use.

All projects are required to provide a narrative summary describing areas of alignment and misalignment of predictive modelling with actual energy use patterns, including modelled EUI and metered EUI. This effort may be designed to support an ongoing commissioning or retro-commissioning process required.

Option 3: Measured performance outcome

Projects may demonstrate compliance with this code by documenting that the building has achieved the EUI performance based on metered energy use after occupancy Metered energy data shall be reported to the building official using Energy Star Portfolio Manager, and adjusted for the percentage of floor area occupied. Data must be collected for 12 consecutive months that is completed within three years of the date of the Certificate of Occupancy

Detached one and two-family dwelling and multiple single-family dwellings less than three stories in height

Option 1: Meeting the ERI target

-ERI (similar to HERS)- comparative energy rating based on a simple tool

-Renewable energy systems may contribute to the ERI rating

Compliance software tools: Software tools used for determining ERI shall be Approved Software Rating Tools in accordance with RESNET/ICC 301

Thermal envelope

Building thermal envelope depiction. The building thermal envelope shall be represented on the construction drawings.

Prescriptive requirements

There are prescriptive requirements surrounding U-values of opaque elements and windows.

Ecosystems around Energy Models | Energiesprong

Energiesprong is not a building energy model or simulation tool

Energiesprong offers an interesting approach to new build and retrofit, in terms of targeted performance, financing and delivery, and it is therefore included here as part of the ecosystem around energy models.

It is a standard and funding approach from the Netherlands. Energiesprong UK have completed various demonstrator projects in the in the UK, it is typically associated with retrofit however the Dutch new-build Energiesprong market is established, and Energiesprong UK have two projects in development in the UK.

It is a flexible outcome-based specification: the target is **Net Zero energy on an annual basis, demonstrated through in-use monitoring and performance-guaranteed in the long-term**. It includes all heat, hot water and appliance use for normal usage. This drives down demand, since only so much can be generated on site.

No specific modelling tool

Solution Providers delivering Energiesprong retrofits will use different modelling tools when developing their solution for a specific property type, but ultimately they have to demonstrate actual performance for every property over the long term, and they have to contractually guarantee it.

Energiesprong UK are agnostic about modelling tools as ultimately the performance guarantee puts the responsibility on the solution provider to ensure that the building meets requirement in-use. Energiesprong UK have seen both SAP and PHPP used; they believe that RdSAP would not be suitable.

A performance guaranteed approach

The performance guarantee means that social housing providers can apply a comfort charge to the tenant which offsets some of the energy savings and provides additional revenue to finance the retrofit. It also allows them build a cost-neutral or better business case based on maintenance and repairs savings. These two elements can provide ~£45k of income and savings over 30 years, compared to a capital cost (when the market is at scale) of ~£50k. RHI, ECO and other funding streams can provide the remainder. Traditional retrofit based on modelled performance provides no guarantee of these income and savings.

ENERGIESPRONG UK – Performance Specification for Demonstrators

Space heating	<p><40 kWh/m²/yr</p> <p>While the modelling is based on standard heating regimes the system must be able to achieve 21°C in living room when outside temperature is -5°C.</p> <p>Use SAP 2012 defaults:</p> <ul style="list-style-type: none"> • Appendix U for local climate data. • All the rooms of a house are heated • A demand temperature of 21oC in the living area and 18oC elsewhere • A weekday heating pattern of 2 hr on, 7hr off, 7hr on 8hr off • A weekend heating pattern of 16 hr on, 8 hr off
---------------	-----------------------------------------------------------------------------------------------------------------------------------------------------------------------------------------------------------------------------------------------------------------------------------------------------------------------------------------------------------------------------------------------------------------------------------------------------------------------------------------------------------------------------------------------------------------------------------

Use gross internal floor area for this metric

kWh per annum allowance for lighting, cooking and sockets	<p>2,300 kWh/yr.</p> <p>Solution provider to update lighting and standard appliances a installation so it is Reasonable that tenants can achieve 2,300 kWh/yr.</p> <p>all gas appliance must be removed as no gas must be used onsite to meet the Energiesprong requirements .</p>
-----------------------------------------------------------	------------------------------------------------------------------------------------------------------------------------------------------------------------------------------------------------------------------------------------------------------------------------------------

Hot water	<p>System has the capacity to deliver 200 litres at greater than 45°C (or equivalent at higher temperatures) in one hour.</p> <p>Hot water consumption to be scaled by typical number of occupants (N) 64+26N, in litres. Housing provider sets typical number of occupants so for N=3, 142 litres per day at a tap temperature not less than 45°C.</p>
-----------	---------------------------------------------------------------------------------------------------------------------------------------------------------------------------------------------------------------------------------------------------------------------------------------------------------------------------------------------------------

Net energy consumption	<p>Net Zero over the year should be achievable on certain well orientated house types, allow <1,500 kWh/yr for others. Net consumption is import (kWh) minus export (kWh) over the year.</p>
------------------------	-------------------------------------------------------------------------------------------------------------------------------------------------------------------------------------------------

Example of what this would mean for a typical house	<p>~4,300 kWh from the PV on the roof, with ~2,000 kWh for heat and hot water delivered and an allocation of 2,300 kWh for appliance use. The only way to achieve this in practice is by reducing heat demand to around 30-40 kWh/m² (or less) delivered through heat pumps</p>
-----------------------------------------------------	--------------------------------------------------------------------------------------------------------------------------------------------------------------------------------------------------------------------------------------------------------------------------------------------

7.3

Important additional information on building energy models and their ecosystems

Relevant building energy models against our 25 recommendations

Example models for our 25 key recommendations for SAP/RdSAP 11

The following table provide examples of existing models, regulation and standards that align with our recommendations

1	SAP can and must become a tool for Net Zero Carbon ready new buildings	<p>The following regulations and best practice standards are tools for Net Zero carbon ready buildings:</p> <ul style="list-style-type: none"> • Minergie (Thermo7) • Passivhaus (PHPP) • British Columbia Step code- Energuide for homes (HOT2000) • Norway TEK 17/ Norwegian Passivhaus (NS 3700, NS 3701) (Simien) • Denmark BR18/Low Energy Class • BENG (The Netherlands)
2	SAP/RdSAP can and must become a better tool for whole house retrofit	<p>A number of the European standards are for both new and refurbished buildings. EnerPHit is worth noting in more detail, as it requires a minimum Airtightness rate and Renewable Energy contribution in addition to the following two routes, in order to achieve the criteria:</p> <ul style="list-style-type: none"> • A prescriptive route, where building elements should meet a minimum required value with targets differing per climate zone, (i.e. arctic, cold, cool temperate, warm-temperate, warm, hot, very hot). • An Energy Demand route, where EnerPHit list a maximum allowed heating and cooling demand per climate zone.
3	SAP/RdSAP can and must become better at evaluating energy use	<p>PHPP: provides an accurate assessment of energy consumption.</p> <p>Predictive modeling /performance modeling- carried out as part of the following models and standard are good at predicting energy use:</p> <p>ILFI zero energy certification, CaGBC zero carbon building standard, The DGNB Climate Positive Award, Toronto zero emissions buildings framework, Vancouver Zero Emissions Building Plan, Washington DC – Appendix Z, City of boulder energy conservation code, Seattle Energy Code.</p> <p>In Australia, National Australian Built Environment Rating System (NABERS) for Apartment Buildings quantify a building’s energy and water performance. Unlike NatHERS, NABERS provides a realistic assessment of how a building is actually performing based on occupant use. However, it can be used for an existing apartment building that has been occupied for at least 12 months only. NABERS does not include energy demand of individual residences within an apartment.</p>
4	Homes need to become smart ready and SAP/RdSAP needs to help with this	<p>California’s code Title 24: a time dependant value weight is applied to the energy consumption results from the model. Currently this is related to variable energy cost, which is partially linked to availability and thus carbon emissions. There are discussions in industry to shift this to closer align with variable carbon factors.</p> <p>Finland: In most European codes, any renewable energy consumption is subtracted from energy consumption of the building, regardless of whether the building actually uses this renewable energy or just sells it back to the grid. In Finland’s energy code, renewable energy production is only included if it is used by the building. This encourages buildings to be ‘smart’ and use the renewable energy that they are generating.</p>

Example models for our 25 key recommendations for SAP/RdSAP 11

5	SAP can and must play a bigger role in reducing the performance gap	<p>Performance modeling using TM 54 reduces the performance gap.</p> <p>In Germany, Finland, Switzerland and Sweden the same simulation tool can be used for design stage predictive modelling and regulatory compliance. This makes it relatively quick to carry out predictive design stage modelling as most of the entries can be re-used from the compliance model. Several UK retrofit methods developed by industry use SAP as basis, but with modifications differentiating them from the regulatory uses of SAP.</p>
7	SAP should remain a steady-state monthly tool, but with a new module for flexibility	<p>There are examples of simulation tools that encourage fabric standards and enable Net Zero that use steady state modeling such as:</p> <p>Regulatory BR18 (Denmark), Swiss SIA380/1 (Thermo 7), Germany (GEG 2020), National code of Finland, Energiguide for homes (BC Step code), BENG (The Netherlands)</p> <p>Voluntary standards PHPP, Minergie and Low Energy Class (Denmark) Methods based on adaptations to SAP/RdSAP e.g. My Home Retrofit Planner, Whole House Plan</p>
8	SAP should 'tell the truth' and enable bespoke non-regulatory uses	<p>CaGBC- Net Zero Carbon Building standard: stipulates conditions such as schedules, occupancy, receptacle loads, and domestic hot water loads shall be based on actual intended operational conditions for the facility in question. The modeler is required to understand building operations as best as possible so that anticipated hours of operation and equipment run times are reflected in the energy model rather than relying on arbitrary defaults from software or applicable code or standards.</p>
10	Overheating: towards a simplified 'flagging system'?	<p>Good Homes Alliance tool: This tool provides guidance on how to assess overheating risk in residential schemes at the early stages of design. It is specifically a pre-detail design assessment intended to help identify factors that could contribute to or mitigate the likelihood of overheating. The score establishes if more detailed analysis should be carried out.</p> <p>Australia: 'National Construction Code (NCC) 2019 Building Code of Australia-Vol 2' requires heating and cooling load limits specified in the 'ABCB standard for NatHERS Heating and Cooling Load Limits' to be met while generating compliance results for regulatory purposes. This allows the software tool to flag loads that exceed the heating or cooling load limit.</p> <p>Netherlands: BENG Criterion 1 requires the maximum yearly energy demand for heating and cooling.</p> <p>Denmark: There is a fictional cooling load penalty. If the tool flags that the home is at risk of overheating, then a fictional cooling loads is automatically added as a penalty.</p> <p>BC step code/ Energiguide for homes: Window operability affects cooling energy consumption so you can use the information in the model to consider overheating.</p>

Example models for our 25 key recommendations for SAP/RdSAP 11

<p>11 SAP/RdSAP outputs need to be compatible with disclosure and data analysis goals</p>	<p>The following regulatory tools have a disclosure requirements: BBR(Sweden), Toronto zero emissions buildings framework, Vancouver Zero Emissions Building Plan, Washington DC – Appendix Z, City of boulder energy conservation code, Seattle Energy Code.</p> <p>The following tools for voluntary standards have disclosure requirements: The DGNB Climate Positive Award, ILFI zero energy certification, CaGBC zero carbon building standard, Energisprong</p>
<p>12 No more notional building: the introduction of absolute energy use targets</p>	<p>The following regulatory tools do not have a notional building they only use absolute targets: BBR(Sweden), TEK10 (Norway), BR18 (Denmark), Finland (National code of Finland), BENG (The Netherlands), Vancouver Zero Emissions Building Plan, Toronto Zero Emissions Building Framework, City of Boulder energy conservation code, Seattle Energy Code, NATHERS (Australia).</p> <p>The following tools for voluntary standards do not have a notional building they only use absolute targets: FEBY (Sweden), Low Energy Class (Denmark) Passivhaus, EnerPHit, My home energy planer, Passeport Efficacité Energétique, Woningpas and iSFP</p> <p>CaGBC Net Zero Carbon standard: absolute targets for space heating demand and relative targets for energy use.</p> <p>The BC step code has various routes to compliance, both the energy use and the space heating demand metric have a relative and an absolute target</p>
<p>13 New metrics for Net Zero Carbon (and not primary energy)</p>	<p>Total energy use Metric</p> <p>The following regulatory tools have a total energy use metric: Toronto zero emissions buildings framework, Vancouver Zero Emissions Building Plan, Washington DC – Appendix Z, City of boulder energy conservation code, Seattle Energy Code, BC step code- Energuide for homes Norway TEK 17*.</p> <p>(1/2) The following tools for voluntary standards have a total energy use metric: CaGBC Zero Carbon Building Design Standard, Zero Code California, Better Home, iSFP, Minergi (these examples are based on net energy consumption: they include the benefit of PV)</p> <p>Space heating metric</p> <ul style="list-style-type: none"> • The following regulatory tools has a thermal demand metric: Finland code, Washington DC Appendix Z, Vancouver Zero Emissions Building Plan, Toronto zero emissions buildings framework, British Columbia Step Code, NATHERS (Australia) • The regulations in Finland and Denmark have a heat loss metric in W/m² • The following tools tools for voluntary standards have a thermal demand metric: Passivhaus, CaGBC Zero Carbon building design Standard, EnerPHit , My Home Energy Planner and Energiesprong • Low Energy Class (Denmark) has a heat loss metric in W/m² and FEBY (Sweden) has a Heat Loss Number (VFT) • The regulations in Germany and Switzerland are based on ‘Energy Demand’ this is the heating and hot water demand + the regulated electricity consumption from ventilation and lighting. This metric sits between the energy use metric and the space heating demand metric.

Example models for our 25 key recommendations for SAP/RdSAP 11

<p>13 New metrics for Net Zero Carbon (and not primary energy)</p> <p>(2/2)</p>	<p>Onsite renewable energy metric</p> <ul style="list-style-type: none"> The following regulatory tools have an onsite renewable metric: DEAP (Ireland), BENG (The Netherlands), French Thermal Regulation RT 2020, GEG (German Regulation), Toronto zero emissions buildings framework, Washington DC – Appendix Z, Title 24 (California). The following tools for voluntary standards have an onsite renewable metric: Minergie, Zero Code California, Passivhaus premium, Energiesprong, ILFI- Net Zero energy, DGNB Climate Positive Award. <p>Peak demand metric</p> <p>CaGBC Net Zero carbon buildings- peak must be disclosed (there is not a target). Hourly electricity demand is outputted by the model and inputted into the ZCB-Design v2 Workbook, which then displayed the modelled summer and winter peak demand of the building.</p>
<p>14 Better governance: a modular architecture and an evidence-based culture</p>	<p>Energy plus: a good example of a transparent tool</p>
<p>17 Location should be taken into account and not normalised as it is now</p>	<p>NatHERS: splits Australia into zones of similar climatic conditions.</p> <p>Switzerland: weather file specific to geographic location, hence project specific climatic data used when calculating heating demand, requiring buildings in colder climate to have better fabric installed as the energy demand targets are the same regardless of location.</p> <p>DGNB - Zero carbon certification: Specific location is used for modeling behind these calculations</p> <p>PHPP: Specific location is used for modeling</p> <p>Performance modeling using TM 54: Specific location is used for modeling</p>
<p>18 Domestic hot water should be modelled more accurately</p>	<p>Australia: For residential house energy efficiency assessment, Department of Environment, Water, Heritage and the Arts (DEWHA) requires addition of hot-water module to the AccuRate software. Research Paper for DEWHA including hot water energy calculation methodology and hot-water module implementation is attached. Also, link below: https://www.nathers.gov.au/sites/default/files/Research%2520Rep%2520%2520Accurate%2520Hotwater%2520Mod.pdf</p>
<p>19 SAP/RdSAP should better model the energy performance of ventilation systems</p>	<p>PHPP: Each individual ventilation unit is inputted including flow rates, along with duct lengths. Calculation includes energy for frost protection.</p> <p>CaGBC: Net Zero Carbon Building standard: Inputs are based on equipment data sheet.</p> <p>TM54: In DSM tools like TAS and IES Systems are modelled and takes account of the design of the system as a whole including duct lengths and their insulation.</p>

Example models for our 25 key recommendations for SAP/RdSAP 11

<p>20 Thermal bridges: good practice should be rewarded (and bad practice penalised)</p>	<p>PHPP: Thermal bridge psi-values for each window frame as well as linear thermal bridges (length and psi values).</p> <p>BC step code/ Energuide for homes: Thermal bridging is calculated on key inputs rather than defined by psi- values. It is defined based on wall/ floor/ roof construction types(stud spacing depths and corners are defined). Window thermal bridges are included as the model understands the wall type and location and thickness of insulation.</p> <p>SIA 380 (Swiss) & Minergie: Standard design to include very Low (good) thermal bridging, backed up with drawings to show compliance of 'very good' thermal bridges to be submitted and checked by auditors. At early stage they force to over-estimate to approximately 20% to encourage other fabric parameters to achieve better design requirements.</p>
<p>21 SAP needs to better reflect all energy uses, including cooking and white goods</p>	<p>Australia: For non-regulatory purposes, the extended tools 'Accurate Sustainability' and 'BERS Pro Plus' of NatHERS have functionality to allow modelling of water use, lighting, hot water and major fixed appliances.</p> <p>The following regulations include all energy uses including cooking and appliances:</p> <ul style="list-style-type: none"> • Europe: Norway, Netherlands, Finland • Canada: British Columbia, Toronto and Vancouver • USA: Washington DC, City of Boulder, Seattle, California
<p>22 Occupancy: the standardised assumptions should be re-validated</p>	<p>PHPP: the number of occupants is set at a default value for certification purposes, but designers can change it if they know the actual number of the future occupants if they want to predict the impact of decisions on future energy use more accurately. This feature is a simple way to enable SAP to be more accurate at predicting energy use.</p> <p>DSM modeling (TAS & IES): allows for input of occupancy profile if the actual number of future occupants is known. This allows for accurate predictive energy modelling.</p>
<p>23 SAP/RdSAP needs to model all heat pump systems accurately to reward efficiency</p>	<p>CaGBC- Net Zero Carbon Building standard: Systems are inputted based on equipment efficiency, performance curve, fan performance, heat recovery effectiveness based on data sheets</p> <p>PHPP: SCOP is calculated by PHPP, with COP inputted at various loads and external temperatures</p>

Example models for our 25 key recommendations for SAP/RdSAP 11

24	Heat networks: SAP/RdSAP should evaluate distribution losses more accurately	PHPP: Pipe losses are calculated very accurately, with the following inputs: pipe length, Delta T, hours utilization, insulation quality and thickness
25	Solar Photovoltaics require better modelling and a prominent SAP/RdSAP output	CaGBC- Net Zero Carbon Building standard: Hourly renewable electricity generation must be provided by the model be entered into the ZCB-Design v2 Workbook, this can come from the simulation tool or another software that specialise in renewable energy generation PHPP: Area, orientation, inclination, kWp output and inverter efficiency are inputs that lead to an accurate assessment on energy generation BC step code/ Energuide for homes: Area, orientation, inclination, module efficiency and inverter efficiency are inputted DSM tools like TAS and IES require orientation, inclination, efficiency of panel, area (in TAS you can draw in 3D the panel), a shading factor, degradation factor, electrical conversion efficiency, among few other inputs.

References

References

This provides the main list of references used in the production of this report. Additional sources were reviewed which are not included here.

Académie des Technologies, Avis de l'Académie des Technologies sur la Réglementation Thermique 2012, la Réglementation Bâtiment Responsable 2020 et le Climat adopté par l'Assemblée le 12 novembre 2014, 2014

<https://www.academie-technologies.fr/blog/categories/communiqués-de-presse/posts/reglementation-thermique-2020-et-climat-l-academie-des-technologies-preconise-de-prendre-en-compte-d-abord-la-consommation-d-energie-finale-et-les-emissions-de-gaz-a-effets-de-serre>

BEIS, Call for Evidence on the Green Deal Framework - Summary of responses to the Call for Evidence, 2018

BEIS, Fuel Poverty Methodology Handbook, produced with BRE, April 2020

Climate Change Committee, 6th Carbon Budget, 2020a

Climate Change Committee, 6th Carbon Budget – policies report, 2020b

Climate Change Committee, 6th Carbon Budget – methodology report, 2020c

Commons Library, House of Commons Research Briefing, Fuel Poverty, Number 8730, 18 November 2020 <https://commonslibrary.parliament.uk/research-briefings/cbp-8730/>

DECC, How the Green Deal will reflect the in-situ performance of energy efficiency measures, 2012

BRE, Green Deal occupancy assessment, 2014

<https://www.bregroup.com/sap/standard-assessment-procedure-sap-2012/green-deal-occupancy-assessments-based-on-sap-2012/>

CGEDD-CGE, Evaluation de la réglementation thermique de 2012 dans les bâtiments neufs en vue de la prochaine réglementation environnementale, Rapport CGEDD n° 010888-01 et CGE n° 2017/08/CGE/SG, 2018

Energy Systems Catapult, A strategy for a Modern Digitalised Energy System, Energy Data Taskforce Report, 2019

Greater London Authority, Review of buildings passports, Etude and Julie Godefroy Sustainability, 2019 - *not published yet but available on request*

Green Construction Board, Buildings Energy Mission 2030: Background Report to Recommendations from the UK Green Construction Board in response to the 2030 Newbuild Challenge, Etude and Julie Godefroy Sustainability, 2019

ITRPV, The International Technology Roadmap for Photovoltaics, 2020 update, April 2020 itrpv.org

Johnston D., Siddall M., Ottinger O., Peper S., Feist W., Are the energy savings of the passive house standard reliable? A review of the as-built thermal and space heating performance of passive house dwellings from 1990 to 2018, Energy Efficiency 13:1605-1631, 2020

UCL, Analyses of metered energy use versus Energy Performance Certificates in Greater London contract TBC – TRN no. 1643/10/2018 to the UK Department for Business, Energy and Industrial Strategy, PI Ruyssevelt, P, 2019

Appendices

A – SAP and Building Regulations

B – SAP across the four nations

C – Initial high-level review of average home size and occupancy in
England and Northern Ireland

D – Reducing the performance gap – beyond SAP

E – Promoting whole house retrofit of existing homes: beyond SAP/RdSAP

F – Review of policy objectives for SAP/RdSAP 11 – Medium and Low
priority

G – Current assessment of SAP10 against policy objectives of
Medium and Low priority for SAP

H – Detailed responses to industry survey

Appendix A | SAP and Building Regulations

The role of SAP/RdSAP for Part L and EPCs

From a regulatory perspective, SAP / RdSAP have 2 main purposes: Part L compliance and EPCs:

- SAP 2012 is the approved methodology for demonstrating compliance with Part L of the Building Regulations for new dwellings, and can be used for works to existing dwellings where design flexibility is desired e.g. extensions.
- SAP/RdSAP are used to produce EPC ratings. They are a direct output from the same methodology as for Part L compliance calculations, but with slightly different assumptions (e.g. reduced internal gains).
- RdSAP has been developed for use in existing dwellings when the complete data set for a SAP calculation is not available. It can be used for the production of EPCs, and also provides guidance input values for use in Part L calculations where information is not available.

Links with Part L and Approved Documents, Building Regulations set requirements, and the Approved Documents give guidance on meeting them. Building Regulations require a target (in carbon emissions) to be set, not how that should be done. The Approved Documents set the use of a notional dwelling for target setting, and together with SAP define the characteristics of that notional dwelling or, for works to existing dwellings where SAP is used, the notional works / extension: SAP is therefore central not only to calculating the (regulated) carbon emissions of a dwelling, but also to setting the targets themselves (dwelling emission rate, and, where applicable, Fabric Energy Efficiency).

Building Regulations, 2010, Regulation 7A Energy Performance of Buildings (England and Wales) 2012 + associated changes to wording clauses 24-27: **setting the requirements**

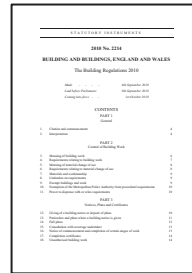

"24. (1) The Secretary of State shall approve (a) a methodology of calculation of the energy performance of buildings, including methods for calculating asset ratings and operational ratings of buildings;
25. The Secretary of State shall approve minimum energy performance requirements for new buildings, in the form of target CO2 emission rates, which shall be set in accordance with the methodology approved pursuant to regulation 24.
25B. Where a building is erected, it must be a nearly zero-energy building
26. Where a building is erected, it shall not exceed the target CO2 emission rate for the building that has been approved pursuant to regulation 25. "



The Notice Approval states the approved methodology is SAP 2012.

The regulations do not define what the target CO2 emission rate should be; it could therefore in theory take several forms e.g. set by a notional dwelling as currently, or a set number (x kgCO2/m2/yr)

Secretary of State Notice of Approval, April 2014: Confirming SAP as the approved methodology for Building Regulations compliance and the production of EPCs (in England and some buildings in Wales)

"For the purposes of compliance with regulations 25, 26, 26A, 27 and 27A of the Buildings Regulations 2010, the target CO2 emission rate, target fabric energy efficiency rate, calculated CO2 emission rate for the dwelling as designed and constructed and calculated fabric energy efficiency rate for the dwelling as designed and constructed shall be calculated using SAP 2012. The asset rating of the dwelling for the purposes of providing an energy performance certificate under regulation 29 of the Building Regulations shall also be calculated using SAP 2012."

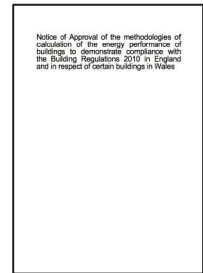

Approved Document Part L1A, 2013 with 2016 amendments: Guidance on how to meet the requirements

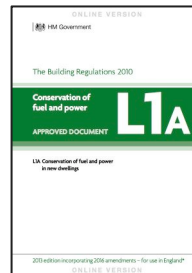

2.3 "In line with the methodology approved by the Secretary of State in the Notice of Approval, the TER and TFEE rate for individual dwellings must be calculated using SAP 2012. "

2.4 -2.6: How the TER and TFEE must be calculated:

- "First calculate the CO2 emissions from a notional dwelling of the same size and shape as the actual dwelling and which is constructed according to the reference values set out in Appendix R of SAP 2012 "
- Setting fuel factors.
- "The TFEE rate is calculated by determining the fabric energy efficiency from a notional dwelling of the same size and shape as the actual dwelling and which is constructed according to the reference values as summarised in Table 4. This fabric energy efficiency is then multiplied by 1.15 to give the TFEE rate."

The targets are set by a combination of the AD (fuel factors and 1.15 TFEE factor) and SAP (calculation methodology, use of a notional dwelling to set the targets, and characteristics of the notional dwelling)



For works to existing dwellings, AD L1B typically describes elemental approaches but it refers to SAP 2012:

- to calculate energy savings, for compliance with requirements to upgrade existing elements.
- to show compliance where design flexibility is desired e.g. comparing extensions with a notional one.

SAP 2012 9.92, October 2013 (including RdSAP – latest version 9.93, November 2017): Approved methodology

Sets out the methodology for "assessing the energy performance of dwellings. The indicators of energy performance are":

- Fabric Energy Efficiency (FEE)
- energy consumption per unit floor area
- energy cost rating, or SAP rating, or, on EPCs, Energy Efficiency Rating (EER)
- Environmental Impact rating based on CO2 emissions (the EI rating) and
- Dwelling CO2 Emission Rate (DER).

The FEE and DER are used for demonstrating compliance with Part L (criterion 1). The SAP rating and Environmental Impact rating are used on EPCs, with rating bands defined by SAP Table 14.

In addition, Appendix R "provides reference values for (...) establishing a target fabric energy efficiency and/or a target CO2 emissions rate (...). The reference values are used to define a notional dwelling of the same size and shape as the actual dwelling."

RdSAP is used on existing dwellings where insufficient information is available for a full SAP calculation.

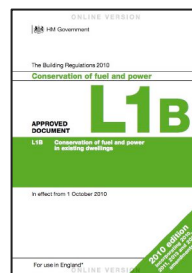
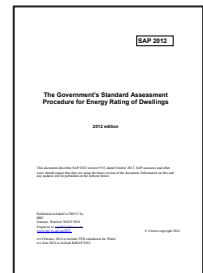



How SAP fits within Building Regulations and associated guidance: Example of England; it is very similar across the 4 nations – see Appendix B

Appendix B | SAP across the four nations

Legislative framework	England	Wales	Scotland	Northern Ireland
Overarching Act	Building Act, 1984	✓	Building (Scotland) Act, 2003	Building Regulations (Northern Ireland) Order, 1979
Building Regulations	Building Regulations, 2010 (as amended) + Regulation 7A Energy Performance of Buildings (England and Wales) 2012 + associated changes to wording clauses 24-27 25: : Requirement for a target carbon emissions rate	✓	Building (Scotland) Regulations, 2004 with amendments most years since; 2020 amendment coming into force in 2021 Scottish Building Standard 6.1: energy performance must be capable of reducing carbon dioxide emissions	Northern Ireland Building Regulations, 2012 §40: Requirement for a target carbon emissions rate
Associated guidance	Approved Document L1A and L1B, 2013, with 2016 revisions Targets are set by adjustments to the TER and TFEF calculated from the notional dwelling, depending on heating fuel type: Fuel factors for TER e.g. electric (direct or heat pumps): 1.55 e.g. oil: 1.17 e.g. mains gas: 1.00 e.g. Any fuel with a CO2 emission factor less than that of mains gas: 1.00 TFEE: FEE of the notional dwelling, multiplied by 1.15	Approved Document L1A and L1B, 2014 with 2016 amendments Targets are set by adjustments to the TER calculated from the notional dwelling, depending on heating fuel type: Fuel factors for TER e.g. electric (direct or heat pumps): 1.55 e.g. oil: 1.17 e.g. mains gas: 1.00 e.g. Any fuel with a CO2 emission factor less than that of mains gas: 1.00 (= as per England) No FEE (but backstop U-values are included within SAP)	Technical handbook, 2019 Targets are set by adjustments to the heating system of the notional dwelling, depending on heating fuel type: e.g. electric: buildings are compared with a notional building with an air source heat pump and no PVs e.g. oil: buildings are compared with a notional building with oil boiler and PVs	Technical Booklet F1, 2012 Targets are set by adjustments to the TER calculated from the notional dwelling, depending on heating fuel type: Fuel factors for TER e.g. electric (direct or heat pumps): 1.47 e.g. oil: 1.17 e.g. mains gas: 1.00 e.g. Any fuel with a CO2 emission factor less than that of mains gas: 1.00 No FEE
Approved methodology	SAP 2012 SAP 10, in draft	✓	✓ (since 2013)	# (SAP 2009)
Target setting for regulatory compliance: a combination of SAP (notional dwelling) + the Building Regulations associated guidance	All 4 nations use the same methodology, SAP. In England this is set by the Secretary of State notice of approval, 2014. In Wales this is set by the Secretary of State for EPC purposes, and by Welsh Ministers for Building regulations purposes. Targets are set through the notional dwelling, also defined in SAP, but with different adjustments across the nations for the heating fuel types, set in Building Regulations associated guidance. In addition, the notional dwelling is slightly different in Scotland			

Appendix C | Initial high-level review of average home size and occupancy in England and Northern Ireland

	England	Northern Ireland
Household characteristics		
Average size of home Overall	94 sqm (English Housing Survey 2018-19 Report xxx)	Tbc – we couldn't find online statistics
Average number of occupants per home	2.4-2.7 <small>(estimated from EHS 2018-9 Lifecourse report, Chapter 1 Annex Table1.7 - see calculation below)</small>	2.4 – 2.5 <small>2.4:https://www.nisra.gov.uk/publications/chs-results 2.5:https://www.statista.com/statistics/524942/average-household-size-in-northern-ireland/ ; Northern Ireland Housing Statistics 2018-19</small>

	Number of households (in the EHS sample)	Number of occupants per household - Low estimate	Number of occupants per household - High estimate
1 person	6,585	1	1
2 people	8,346	2	2
3 people	3,697	3	3
4 people	3,330	4	4
5 people or more	1,575	<u>5</u>	<u>10</u>
Total across all households	23,534	55,563 total 2.36 average	63,438 total 2.70 average

Average number of occupants per home, for England, estimated using data from EHS Annex Table 1.7: Household size, by age, 2018-19 (high level estimate based on data available)

Appendix D | Reducing the performance gap – beyond SAP/RdSAP

SAP/RdSAP can only address some of the reasons behind the performance gap, and actions in several parts of the regulatory framework are therefore recommended. Generally, we expect that these would align strongly with the government’s objectives for improve construction quality.

Regulatory changes should aim to:

- Improve every step of the delivery chain, from user inputs through to operation
- Create a culture of respect and trust in SAP/RdSAP, encouraging better inputs, more interrogation of the results
- Improve enforcement and regulatory compliance
- Create learning loops from monitoring in-use.

Closing the performance gap: tackling every step outside of SAP/RdSAP

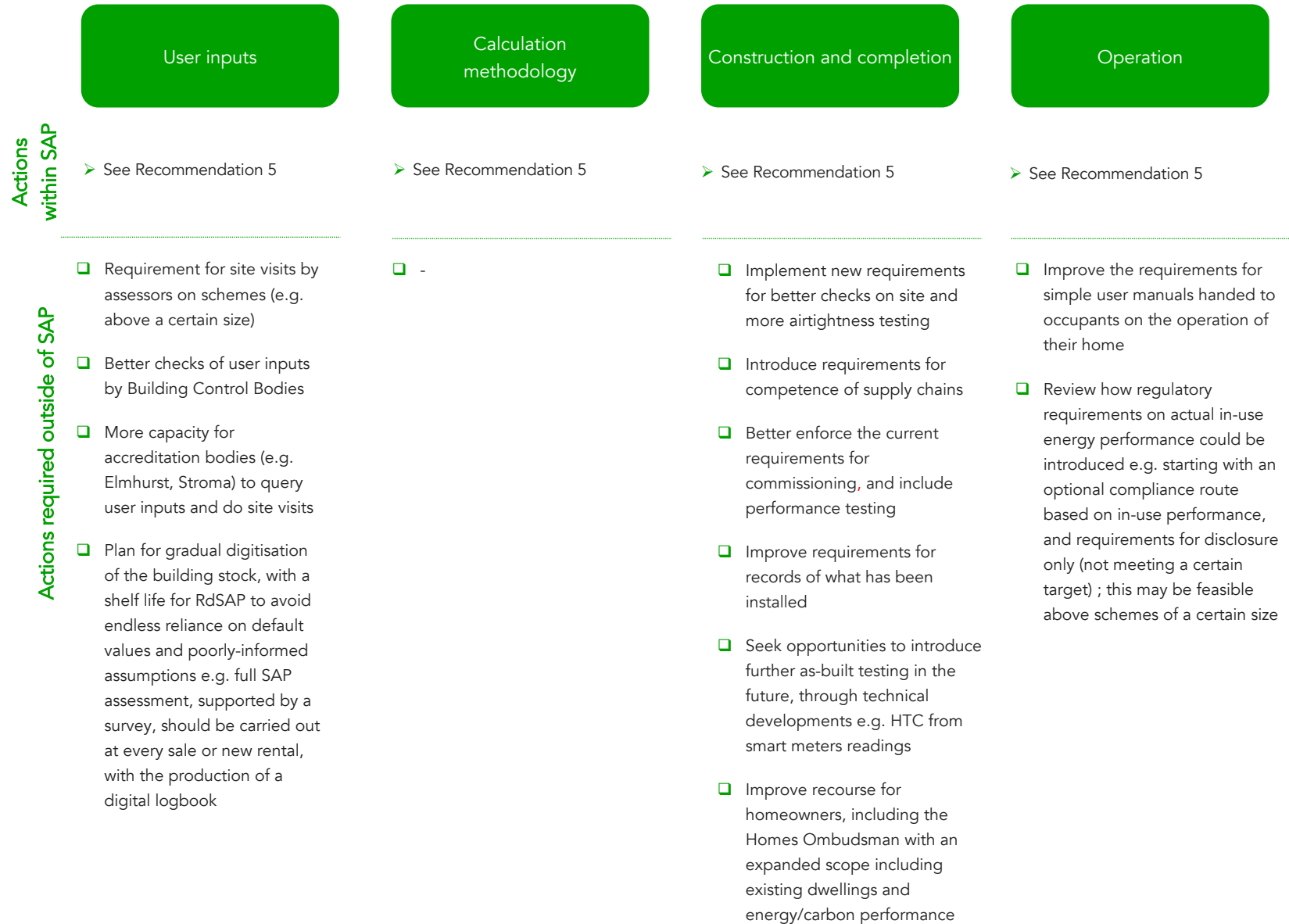

Appendix E | Promoting whole house retrofit of existing homes: beyond SAP/RdSAP

Changes to SAP and RdSAP described in Recommendation 2 can only go so far, and must be supported by changes to the regulatory framework.

SAP /RdSAP should be used more widely on existing dwellings

Currently, for Building Regulations compliance on existing dwellings SAP is typically only used where design flexibility is required e.g. extensions, and to assess consequential improvements. Opportunities are missed for whole dwelling assessments, with instead elements examined in isolation from others. Building Regulations should be amended to extend the cases where SAP should be used.

Digitisation of the building stock: a shelf life for RdSAP

RdSAP is very common, and was created for cases where a full set of SAP data entries is not available. It is a system of set assumptions and data collection through site visits to generate that dataset for entry in SAP: the calculations are the same. The issue is that despite the site visit, many inputs are set or assumed, which could be obtained with more detailed surveys and tests. This perpetuates an approach based on poor data, particularly on fabric. RdSAP should be phased out:

- Limit RdSAP to situations where a full SAP would be too onerous e.g. short lets or minor works, as opposed to long lets, sales, significant works and extensions.
- Ensure that investment in the first full SAP and survey is only needed once: both should be digitised and available to future owners and residents so that even in limited works, a full SAP could be produced by only modifying relevant inputs.

Regulations to promote deep whole house retrofit where possible

The approach to improvements needs to be fundamentally re-examined :

- Review how to account for and address state of repair before energy works
- Ensure retrofit measures are consistent with the end goal of energy reduction and transition away from fossil fuels e.g. new insulation should be at one-off “Net Zero compliant” levels; like-for-like works should be gradually phased out when not consistent with the low-carbon transition e.g. gas boilers.
- Require ‘minimum’ improvements e.g. draught proofing, controls
- Assess measures together, against the end goal. Prompt for measures that go well or must go together, especially with regards to ventilation, overheating and moisture, when insulation and airtightness improvements are considered.

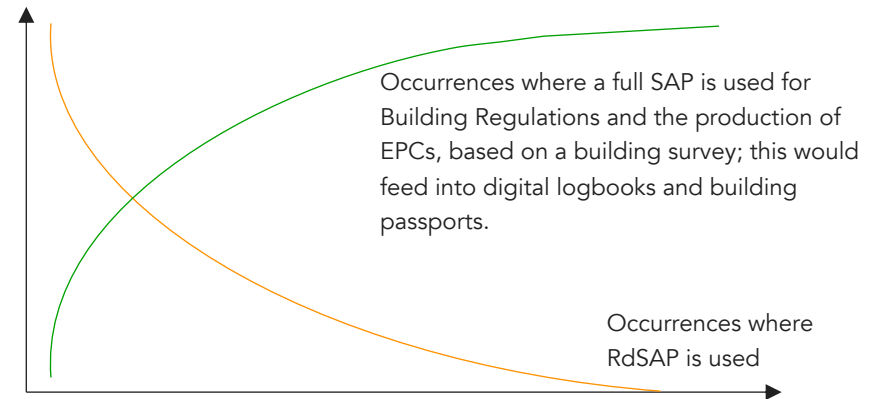

Regulations should be amended to require the production of a full SAP in more cases, including in the production of EPCs. For example, a building survey and full SAP should be reasonable to expect when a home is sold, and possibly in long lets. Over time, digitisation would reduce the instances where a full survey is needed, as the survey and full SAP would remain available and only the relevant inputs would need be updated

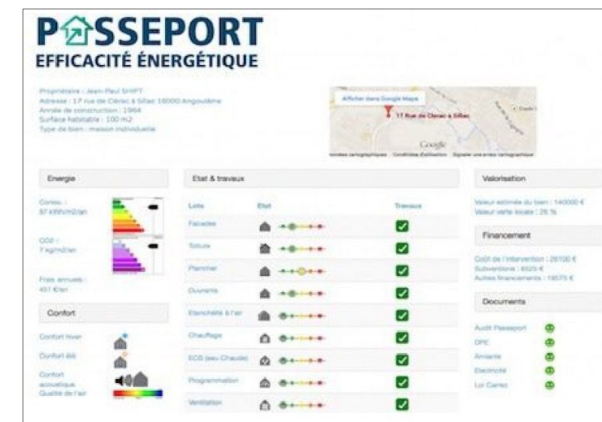

Building renovation passports are widely acknowledged as an essential part to carry out deep retrofit of the existing stock, and unlock finance. By becoming a better energy tool, SAP could much better support them

Appendix F | Review of policy objectives for SAP/RdSAP 11: High priority

Policy objective			How is the objective currently linked to SAP?	Associated function of SAP / RdSAP 11
Overarching objective	Policy reference	Specific policy objective		
Net Zero Carbon by 2050 incl. whole building stock* as well as energy system	Climate Change Act, 2019 amendment	New homes: "Net Zero ready" by 2025 – operational emissions	Close link: SAP method and outputs; also through National Housing Model, which is based on SAP	<ul style="list-style-type: none"> Evaluate carbon emissions (including all operational emissions) Set targets and encourage the right design and build decisions for now and the long-term
	-	Existing homes – tbc		<ul style="list-style-type: none"> As for new homes, but possibly as steps e.g. minimum compliance + end goal + Net Zero transition plan
	Planning White Paper, 2020	Embodied emissions – none specific	Not currently considered, but potentially could	<ul style="list-style-type: none"> Evaluate embodied carbon emissions e.g. initial embodied carbon, if not in-use embodied carbon for replacement, maintenance etc
Improving energy efficiency and reducing demand	Clean Growth Strategy - Buildings Mission	New homes: halve energy use by 2030	Close link: SAP method and outputs, via Building Regulations	<ul style="list-style-type: none"> Evaluate energy consumption
		Existing homes : halve the cost of achieving the same standard	Close link: SAP and EPC method and outputs, via Building Regulations and ECO / PAS 2035	<ul style="list-style-type: none"> As for new homes: evaluate energy consumption Possibly: evaluate retrofit costs See also 'Construction Quality' objective in Appendix
	Clean Growth Strategy MEES	Private rented sector: EPC-E or better, unless exemptions. EPC-C by 2035 (commitment for fuel-poor homes, ambition for others)	Close link: EPC method and outputs (EER)	<ul style="list-style-type: none"> Produce a reliable asset rating of energy performance And/or evaluate energy consumption (total or possibly regulated, absolute or possibly relative)
Heat decarbonisation	Future Homes Standard consultation	New homes – no fossil fuel heating from 2025	Close link: SAP targets and outputs	<ul style="list-style-type: none"> Evaluate annual energy consumption for heat Evaluate peak demand for heat and for electricity overall (+ sub-metrics e.g. management and timing of peak?)
	Upcoming Heat Strategy - tbc	Existing homes – tbc	Close link: SAP / RdSAP targets and outputs, through Building Regulations and other means e.g. ECO / PAS 2035	<ul style="list-style-type: none"> Indicate and account for demand management capability (thermal and electrical) Report on transition from fossil fuels e.g. carbon content of heat, future zero-carbon heat options
	Heat market framework consultation; upcoming Heat Strategy - tbc	Encourage low-carbon new heat networks; no set objective for existing networks	Close link: SAP and EPC method and outputs, via Building Regulations and to some extent ECO / PAS 2035	<ul style="list-style-type: none"> As above, but to be done at building <u>and</u> at scheme level, accounting for district scheme efficiency

Summary of policies related to SAP for delivery and/or tracking, and what the "ideal" metrics and functions of SAP should be to help towards that objective

* only very minor exceptions for the existing building stock: > 99% reduction

Appendix F | Review of policy objectives for SAP/RdSAP 11: Medium priority

Policy objective			How the objective is currently linked to SAP	Associated test for SAP / RdSAP 11 <u>in an ideal world</u>
Overall objective	Policy reference	Specific policy objective		Function of SAP
Construction quality	Misc e.g. Our Broken Housing Market; Each Home Counts	Improving quality, reducing gap between design and as-built performance	Close / direct link: SAP inputs and outputs	<ul style="list-style-type: none"> Inputs and outputs which are meaningful to builders and supply chains, and verifiable e.g. through photographic evidence and as-built checks and tests Outputs which are meaningful to residents e.g. energy consumption Simple to use, to reduce risk of errors and shortcuts <p><i>Note: We focus here on the methodology itself. There are many reasons to the performance gap. In particular, there are enforcement issues, and the regulations could be modified to require more as-built and in-use checks.</i></p>
	Fixing our broken housing market, 2017	Supporting construction methods which improve cost, speed and quality e.g. MMC, digitisation –	Allowing flexibility to innovative solutions, including: <ul style="list-style-type: none"> Flexible to new systems and products e.g. new heating systems; ability to assess façade assembly, or even “template” homes? Reliable assessment of system performance; rewarding technology where it performs and is well implemented, but not encouraging over-complexity Simple to use 	
Reducing fuel poverty	2015 Fuel Poverty Strategy - Delivered through ECO + MEES + new support schemes (tbc)	Fuel poor homes to achieve EPC rating of C by 2030 (E by 2020 and D by 2025)	Close / direct link: EPC method and outputs (EER); SAP inputs, method and outputs for appraisal of some ECO measures (e.g. district heating)	<ul style="list-style-type: none"> Evaluate energy running costs (related to total energy use)s. Note that actual costs vary with energy suppliers. In addition, bills include components not related to unit energy use, particularly in district heating schemes e.g. recouping investment and maintenance costs. SAP could therefore, realistically, only ever provide a partial and comparative picture of likely energy running costs. and/or Evaluate energy consumption
Engagement with customers	Fixing our broken housing market, 2017; Each Home Counts?	-	Close / direct link: SAP outputs	<ul style="list-style-type: none"> Evaluate energy consumption, and possibly the associated energy costs – this should be available as a split per fuel, to relate to consumer bills. EPC ratings are confusing and misunderstood by consumers. Meaningful and relatable outputs are required to engage residents, such as energy running costs or total energy use; the distinction between regulated and unregulated energy means little to the large majority of residents
Increasing renewable energy generation	-	-	Close / direct link: SAP inputs, method and outputs	<ul style="list-style-type: none"> Evaluate on-site renewable energy generation (kWh/yr; also peak?), and possibly the associated carbon savings; potentially, assess this against the maximum potential contribution
Demand management	-	-	Related: SAP inputs, method and outputs	<ul style="list-style-type: none"> Evaluate peak electrical demand (+ sub-metrics e.g. management / timing of peak ?) Indicate and account for electrical demand management capability Account for interaction between buildings, vehicles and grid e.g. EV charging point, shared battery

Summary of policies related to SAP for delivery and/or tracking, and what the “ideal” metrics and functions of SAP should be to help towards that objective

Appendix F | Review of policy objectives for SAP/RdSAP 11: Low priority

Policy objective			How the objective is currently linked to SAP	Associated test for SAP / RdSAP 11 <u>in an ideal world</u>
Overall objective	Policy reference	Specific policy objective		Function of SAP
Electrification of transport	-	Each new home to have an EV charging point	Related: SAP inputs, method, targets, and outputs	<ul style="list-style-type: none"> Evaluate peak electrical demand (+ sub-metrics e.g. management / timing of peak ?) Indicate and account for electrical demand management capability Account for interaction between buildings, vehicles and grid e.g. EV charging point, shared battery
Faster housing delivery	Planning White Paper	tbc		
		See above on construction quality – construction methods		
	Misc	“Smart” homes & other technology trends	Related: SAP inputs and method	Allowing flexibility to innovative solutions, including: <ul style="list-style-type: none"> Flexible to new systems and products e.g. new heating systems; ability to assess façade assembly, or even “template” homes? Reliable assessment of system performance; rewarding technology where it performs and is well implemented, but not encouraging over-complexity Simple to use
Health & wellbeing	Misc, as part of public health strategy for England; Clean Growth Strategy Ageing Society Mission	Support health and wellbeing through the home (= prevention before healthcare), including that of an ageing population – no specific objective, but some guidance in 2019 Design Guide	Potential for close / direct link, but currently partial: SAP inputs, outputs and method, through Building Regulations	<ul style="list-style-type: none"> Evaluate overheating risk through test / indicator Evaluate the provision of daylight through test / indicator Evaluate indoor air quality through test / indicator Possibly allow the introduction of further requirements in the future. Create better links with the Housing Health and Rating System (HHSRS)

Summary of policies related to SAP for delivery and/or tracking, and what the “ideal” metrics and functions of SAP should be to help towards that objective

Appendix G | Current assessment of SAP10 against policy objectives : Medium priority

Policy objective	SAP 10 performance against this objective
Construction quality	<p>Partial:</p> <ul style="list-style-type: none"> Some inputs are not entered correctly, whether intentionally or not e.g. for time saving. Different SAP outputs would be easier to verify e.g. energy consumption; possibly heat transfer coefficient through smart meters? The treatment of thermal bridging, including the ability to use default values which are not very penalising, misses an opportunity to address design and construction quality
Reducing fuel poverty	<p>Partial:</p> <ul style="list-style-type: none"> The SAP rating, used in EPCs, relates to energy costs. However, it cannot account for all energy costs (e.g. fixed charges in district heating schemes) and relies on regular updates to reflect real trends in energy costs. A key component to reduce fuel poverty, and one controlled by building designers and regulators, is to reduce energy consumption. There are concerns about how SAP performs against this – see above.
Engagement with consumers	<p>Poor:</p> <ul style="list-style-type: none"> The main engagement of consumers is with EPCs, and this is very partial and often based on misunderstandings due to the use of a cost rating, which is called “energy efficiency rating” and therefore easily misunderstood The SAP outputs, including regulated energy uses only, do not directly relate with the experience of consumers. Moving to primary energy as main metric, as is proposed, would make things worse as this will mean little to the very large majority of consumers Assessing dwellings under a set geographical location means that the experience of consumers in terms of comfort and energy bills can be markedly different in different parts of the country, for the same level of Part L compliance and EPC rating Assessing dwellings against a moving target (the notional dwelling) means that the experience of consumers in terms of comfort and energy bills can be markedly different, for the same level of Part L compliance and EPC rating
Increasing renewable energy generation	<p>Partial:</p> <ul style="list-style-type: none"> SAP 10 does not account for solutions which can improve the efficiency of PV systems, and so does not encourage them
Demand management	<p>Poor:</p> <ul style="list-style-type: none"> There is no metric and output related to peak demand SAP 10 is not well adapted to demand management design strategies and technologies FEES to some extent encourage a reduction in demand, but still work by comparison to a notional dwelling and the link to demand is indirect and they cannot be verified at the as-built or in-use stage

Appendix G | Current assessment of SAP10 against policy objectives : Low priority

Policy objective	SAP 10 performance against this objective
Electrification of transport	<ul style="list-style-type: none"> Not currently considered – options examined by SAP-IF for future development
Faster housing delivery	<p>Partial:</p> <ul style="list-style-type: none"> SAP provides relative targets against a notional building, or via EPC ratings. It does not set absolute targets and steps towards a Net Zero carbon end goal, which could define a clear and consistent framework for leadership in planning requirements While SAP promotes an overall performance approach rather than prescriptive and elemental requirements, it is not always fully flexible or fast enough to respond to new approaches, products and systems.
Health and wellbeing	<p>Poor – this is not its purpose currently:</p> <ul style="list-style-type: none"> SAP considers ventilation, daylight and temperature only in so far as they affect energy consumption, not in their impacts on comfort or health

Appendix H

Detailed responses to industry survey



Appendix H | The Future of SAP and RdSAP – Survey Results

Q5. Metrics

Indicate whether the metric should be a key metric, secondary metric, or not a metric in SAP at all.

218 respondents

The following options were presented and respondents asked to select 1 of the 3.

Metric	Key	Secondary	Not at all
Energy consumption	85%	14%	1%
Carbon emissions	65%	29%	5%
Space heating demand	60%	36%	4%
Primary energy	53%	35%	12%
Overheating risk	46%	39%	15%
Energy running costs	40%	49%	11%
Renewable energy generation	37%	54%	9%
Peak demand	25%	61%	15%
Electrical demand 'shifted'	15%	64%	21%

An open response was allowed for suggested alternative metrics. These are recorded in a separate spreadsheet available to BEIS.

Q6. Target Setting

Please indicate your preferred option for target setting.

219 respondents

The following options were presented and respondents asked to select 1 of the 4.

Option	Response
Energy consumption	85%
Carbon emissions	65%
Space heating demand	60%
Primary energy	53%

An open response was allowed for additional comments, justification or supporting evidence. These are recorded in a separate spreadsheet available to BEIS.

Appendix H | The Future of SAP and RdSAP – Survey Results

Q7. Retrofit

Please indicate your level of agreement with the following statement: SAP/RdSAP should become a tool for deep whole house retrofit of existing homes.

219 respondents

Respondents were asked about their level of agreement.

Option	Response
Strongly agree	30%
Agree	35%
Neither agree or disagree	17%
Disagree	8%
Strongly disagree	5%
Not sure	5%

An open response was allowed for additional comments, justification or supporting evidence. These are recorded in a separate spreadsheet available to BEIS.

Q8. Retrofit Options

Several options are potentially available in order for SAP/RdSAP to become a tool for deep whole house retrofit of existing homes. Please indicate your level of agreement with the following options.

216 respondents

The following options were presented and respondents asked about their level of agreement.

Metric	Strongly agree	Agree	Neither agree or disagree	Disagree	Strongly disagree
Introduce an evaluation of the possible “end goal” representing a low-carbon deep retrofit, even if the regulatory target is different at that point	42%	38%	15%	2%	3%
Introduce prompts to encourage a whole house approach e.g. automatic “have you reviewed the ventilation?” if insulation or airtightness is improved	47%	40%	8%	2%	3%
Take better account of airtightness and associated improvements	51%	36%	11%	1%	1%

An open response was allowed for additional comments, justification or supporting evidence. These are recorded in a separate spreadsheet available to BEIS.

Appendix H | The Future of SAP and RdSAP – Survey Results

Q9. RdSAP Defaults

Do you have evidence related to the current approach to default values in RdSAP?

81 respondents

Respondents were asked to provide an comment.

An open response was allowed for comments and supporting evidence. These are recorded in a separate spreadsheet available to BEIS.

Q10. Further SAP Uses

It could be possible to enable the use of SAP where, for non-regulatory purposes, users would be able to modify some of the inputs (e.g. occupancy); they may also test scenarios such as future climate, or ranges of possible U-values (e.g. on existing buildings where current performance may be uncertain) etc. If such a function was available, do you think it would be of use to you and/or the wider industry?

217 respondents

The following options were presented and respondents asked about their level of agreement.

Option	Response
Yes, very much	42%
Yes, probably	43%
Probably not	6%
Not at all	2%
Not sure	6%

An open response was allowed for additional comments, justification or supporting evidence. These are recorded in a separate spreadsheet available to BEIS.

Appendix H | The Future of SAP and RdSAP – Survey Results

Q11. Building Location

SAP/RdSAP calculations are currently done assuming the same location, not the actual location of the dwelling. Please indicate your level of agreement with the following statement: The assessment of dwellings should be based on their actual location, not normalised as it is now.

217 respondents

Respondents were asked about their level of agreement.

Option	Response
Strongly agree	61%
Agree	26%
Neither agree or disagree	6%
Disagree	3%
Strongly disagree	1%
Not sure	2%

An open response was allowed for additional comments, justification or supporting evidence. These are recorded in a separate spreadsheet available to BEIS.

Comments were particularly sought, if respondents agreed with the above statement, on whether regional zones and climatic data currently used for the overheating test (Appendix U) would be appropriate.

Q12. Carbon Factors

Please indicate your preferred option, out of the following.

215 respondents

The following options were presented and respondents asked to select 1 of the 4.

Option	Response
The carbon factors should be based on a short-term average (3-5 years) i.e. similar to the current approach in SAP	40%
The carbon factors should be based on a medium-term average (20-30 years)	34%
The carbon factors should be based on a long-term average (50 years)	5%
Not sure	21%

An open response was allowed for additional comments, justification or supporting evidence. These are recorded in a separate spreadsheet available to BEIS.

Appendix H | The Future of SAP and RdSAP – Survey Results

Q13. Modelling Approach

Please indicate your preferred option, out of the following.

216 respondents

The following options were presented and respondents asked to select 1 of the 5.

Option	Response
SAP should remain purely a steady-state monthly energy modelling tool, as currently	3%
SAP should remain a steady-state monthly energy modelling tool in the main, but with the ability to model specific aspects more accurately (e.g. peak demand, thermal storage), using a steady-state hourly step calculation (e.g. applied to shorter periods, such as a typical peak day)	25%
SAP should remain a steady-state monthly energy modelling tool in the main, but with the ability to model specific aspects more accurately (e.g. peak demand, thermal storage), using a dynamic modelling calculation	27%
SAP should become a fully dynamic calculation	29%
Not sure	15%

An open response was allowed for additional comments, justification or supporting evidence. These are recorded in a separate spreadsheet available to BEIS.

Q14. Overheating

Please indicate your preferred option, out of the following.

217 respondents

The following options were presented and respondents asked to select 1 of the 4.

Option	Response
There should be an overheating test, which would remain more or less as currently in the draft SAP 10 (possibly with small modifications); this could possibly feed back into the energy consumption calculation.	15%
There should be an overheating test, but it should be much simpler, and flag up whether a more detailed assessment is required	30%
All new dwellings should undergo a much more detailed overheating test, for example dynamic modelling against CIBSE TM59. This may mean it becomes separate from the SAP calculation.	45%
Not sure	10%

An open response was allowed for additional comments, justification or supporting evidence. These are recorded in a separate spreadsheet available to BEIS.

Appendix H | The Future of SAP and RdSAP – Survey Results

Q15. Unregulated Energy

Please indicate your level of agreement with the following statement: SAP needs to better estimate all energy uses, including cooking and appliances, even if these uses do not become regulated by the Building Regulations.

217 respondents

Respondents were asked about their level of agreement.

Option	Response
Strongly agree	47%
Agree	26%
Neither agree or disagree	15%
Disagree	6%
Strongly disagree	5%
Not sure	2%

An open response was allowed for additional comments, justification or supporting evidence. These are recorded in a separate spreadsheet available to BEIS.

In particular, we were interested in views on adjustments that could or should be done to the current estimate of unregulated loads, measured in-use data on these loads, and how they relate to space heating and total energy consumption.

Q16. Demand Management

Please indicate your level of agreement with the following statement: SAP needs to encourage and reward demand management (including demand reduction).

217 respondents

Respondents were asked about their level of agreement.

Option	Response
Strongly agree	40%
Agree	40%
Neither agree or disagree	8%
Disagree	3%
Strongly disagree	3%
Not sure	6%

An open response was allowed for additional comments, justification or supporting evidence. These are recorded in a separate spreadsheet available to BEIS.

Appendix H | The Future of SAP and RdSAP – Survey Results

Q17. Model Demand Management

How can SAP better model and encourage demand management? Please indicate your level of agreement with the following options. Feel free to comment on these options or provide additional suggestions in the comments box.

214 respondents

The following options were presented and respondents asked about their level of agreement.

Option	Strongly agree	Agree	Neither agree or disagree	Disagree	Strongly disagree
Evaluate and report on peak electrical demand (kW)	34%	43%	19%	2%	2%
Better account for and reward electric storage	33%	47%	17%	1%	2%
Better account for and reward thermal storage	33%	47%	17%	2%	1%
Better account for and reward smart technologies (other than storage) e.g. smart controls	38%	37%	20%	2%	2%

An open response was allowed for additional comments, justification or supporting evidence. These are recorded in a separate spreadsheet available to BEIS.

Q18. Thermal Bridges

Please indicate your level of agreement with the following statement: The assessment of thermal bridges needs to be improved.

217 respondents

Respondents were asked about their level of agreement.

Option	Response
Strongly agree	44%
Agree	32%
Neither agree or disagree	13%
Disagree	2%
Strongly disagree	0%
Not sure	7%

Some of the options potentially available to make the assessment of thermal bridges more detailed include: requiring accurate length measurement of thermal bridges; default values which are more penalising to encourage the use of specific Psi-values; a more extensive database of thermal bridging calculations for construction details.

Respondents were asked if they had any comments on these options, or additional suggestions and supporting information.

These are recorded in a separate spreadsheet available to BEIS.

Appendix H | The Future of SAP and RdSAP – Survey Results

Q19. Heat Pumps

Please indicate your level of agreement with the following statement: SAP needs to model heat pumps more accurately.

217 respondents

Respondents were asked about their level of agreement.

Option	Response
Strongly agree	54%
Agree	30%
Neither agree or disagree	9%
Disagree	1%
Strongly disagree	0%
Not sure	6%

Some of the options potentially available to make the modelling of heat pumps more accurate include: better taking account of heat source temperature and its seasonal variations; taking account of flow temperature and its impact on Seasonal Coefficient of Performance (SCOP); better accounting for operating profiles, to encourage designs that limit peaky on/off operation, and to take account of its effects on performance if it is likely to happen; allowing “free input” of SCOPs to represent specific products.

Respondents were asked if they had any comments on these options, or additional suggestions and supporting information.

These are recorded in a separate spreadsheet available to BEIS.

Q20. PV

Please indicate your level of agreement with the following statement: SAP needs to model solar photovoltaic (PV) electricity generation more accurately. |

217 respondents

Respondents were asked about their level of agreement.

Option	Response
Strongly agree	35%
Agree	35%
Neither agree or disagree	17%
Disagree	4%
Strongly disagree	1%
Not sure	8%

Some of the options potentially available to make the modelling of PVs more accurate include: taking account of module level power electronics e.g. microinverters or DC optimisers; taking account of bifacial modules; taking account of solar module power output warranties.

Respondents were asked if they had any comments on these options, or additional suggestions and supporting information.

These are recorded in a separate spreadsheet available to BEIS.

Appendix H | The Future of SAP and RdSAP – Survey Results

Q21. Heat Networks

Please indicate your level of agreement with the following statement: SAP should be more accurate in how it takes account of heat networks.

217 respondents

Respondents were asked about their level of agreement.

Option	Response
Strongly agree	41%
Agree	32%
Neither agree or disagree	14%
Disagree	1%
Strongly disagree	0%
Not sure	12%

In particular, we were interested in views on how distribution losses should be assessed (e.g. as absolute losses, or as a proportion of demand as is the case currently).

Respondents were asked if they had any comments on these options, or additional suggestions and supporting information.

These are recorded in a separate spreadsheet available to BEIS.

Q22. Ventilation

Please indicate your preferred option, out of the following.

217 respondents

The following options were presented and respondents asked to select 1 of the 4.

Option	Response
SAP should keep the way ventilation is modelled	18%
SAP should broadly keep the way ventilation is modelled, but change some of the details and/or options available – please detail in the comment box	29%
SAP should fundamentally change the way ventilation is modelled – please detail in the comment box	23%
Not sure	31%

Some of the options potentially available to modify the modelling of ventilation include: entering the length of duct runs; further encourage the use of rigid ductwork; introduce a penalty on ventilation performance in as-built calculations, until evidence of commissioning is provided; introduce improvements to the parameters provided in Appendix Q / PCDB e.g. taking account of filters in Specific Fan Power values.

Respondents were asked if they had any comments on these options, or additional suggestions and supporting information.

These are recorded in a separate spreadsheet available to BEIS.

Appendix H | The Future of SAP and RdSAP – Survey Results

Q23. Hot Water

Do you have evidence of how actual hot water consumption in-use compares to that evaluated in SAP? This could be in kWh energy for hot water or in litres of hot water (per person, or per sqm).

57 respondents

Respondents were asked to provide a comment.

An open response was allowed for comments and supporting evidence. These are recorded in a separate spreadsheet available to BEIS.

Q24. Refrigerant

Currently SAP does not account for greenhouse gas emissions from refrigerant leakage (e.g. heat pumps). Please select your preferred option(s) out of the following (you may choose several):

217 respondents

The following options were presented and respondents selected which was their preferred option(s) with no limit on the number of selections. *Total does not sum to 100%.*

Option	Preferred
Refrigerant leakage is an important issue, but it should be dealt with in another way, outside of SAP	40%
Emissions associated with refrigerant leakage are not part of 'operational carbon emissions': they are part of embodied global warming potential emissions, so they should not be included in SAP	19%
Emissions associated with refrigerant leakage should be an output from SAP, as indicator or as a separate metric	30%
Not sure	21%

An open response was allowed for additional comments, justification or supporting evidence. These are recorded in a separate spreadsheet available to BEIS.

Appendix H | The Future of SAP and RdSAP – Survey Results

Q25. Performance Gap

Please indicate your level of agreement with the following statement: SAP /RdSAP should play a bigger role in reducing the performance gap.

217 respondents

Respondents were asked about their level of agreement.

Option	Response
Strongly agree	64%
Agree	25%
Neither agree or disagree	6%
Disagree	0%
Strongly disagree	1%
Not sure	3%

An open response was allowed for additional comments, justification or supporting evidence. These are recorded in a separate spreadsheet available to BEIS.

Q26. Performance Gap Options

Several options are potentially available to modify SAP/RdSAP and help reduce the performance gap. Some of these options are covered in earlier questions of this survey. Please indicate your level of agreement with the following additional options.

214 respondents

The following options were presented and respondents asked about their level of agreement.

Option	Strongly agree	Agree	Neither agree or disagree	Disagree	Strongly disagree
Improving accessibility and transparency e.g. open-source calculations, easily available evidence base	48%	36%	14%	3%	0%
Including a measurable space heating metric (e.g. Heat Transfer Coefficient) on the SAP output report and EPC report, to make direct comparisons with as-built values easier	42%	39%	16%	2%	1%
Introducing a penalty on as-built system performance unless there is evidence of commissioning results	41%	34%	17%	6%	3%
Improving the information set-out in SAP output reports and EPC reports for home occupiers	48%	36%	14%	1%	1%

An open response was allowed for additional comments, justification or supporting evidence. These are recorded in a separate spreadsheet available to BEIS.